



Register your
new device on
MyBosch now and
get free benefits:
**[bosch-home.com/
welcome](https://bosch-home.com/welcome)**



Built-in oven

VBC578FS0

[en] Instruction manual
[zh] 说明手册

Built-in oven
烤箱

3
27

Table of contents

 Intended use	4	 Cleaning	17
 Important safety information	4	Suitable cleaning agents	17
General information	4	Keeping the appliance clean	18
Cleaning function	5	Cleaning the cooking compartment	18
 Causes of damage	6	 Cleaning function	19
General information	6	Pyrolytic self-cleaning	19
 Environmental protection	7	 Rails	20
Saving energy	7	Detaching the shelf supports	20
Environmentally-friendly disposal	7	Refitting the shelf supports	20
 Getting to know your appliance	8	 Appliance door	20
Control panel	8	Removing and installing the door panels	20
Buttons	8	Removing and fitting the appliance door	21
Display	8	 Trouble shooting	22
Types of heating and functions	9	Fault messages	22
Temperature selector	9	Replacing the oven light bulb	23
Cooking compartment functions	10	 Customer service	23
 Accessories	10	E number and FD number	23
Shelf positions	10	Distributor and origin information:	23
Locking function	11	 Tested for you in our cooking studio	24
Telescopic rail set	11	Table of dishes	24
Special accessories	11	Tips for using your appliance	25
 Before using for the first time	12		
Setting the time on the clock	12		
Baking out the oven	12		
Cleaning the accessories	12		
Fitting the telescopic shelf set	12		
 Operating the appliance	13		
Switching the oven on and off	13		
Rotary spit	13		
Automatic safety switch-off function	14		
 Time-setting options	14		
Overview of the time-setting options	14		
Operating the electronic clock	14		
Setting the automatic timer	15		
 Childproof lock	16		
Activating the childproof lock	16		
Deactivating the childproof lock	16		
 Basic settings	16		
List of basic settings	16		
Changing the basic settings	17		
Setting energy-saving mode	17		

Additional information on products, accessories, replacement parts and services can be found at www.bosch-home.com and in the online shop www.bosch-eshop.com

Intended use

Read these instructions carefully. Only then will you be able to operate your appliance safely and correctly. Retain the instruction manual and installation instructions for future use or for subsequent owners.

This appliance is only intended to be fully fitted in a kitchen. Observe the special installation instructions.

Check the appliance for damage after unpacking it. Do not connect the appliance if it has been damaged in transport.

Only a licensed professional may connect appliances without plugs. Damage caused by incorrect connection is not covered under warranty.

This appliance is intended for domestic use only. The appliance must only be used for the preparation of food and drink. The appliance must be supervised during operation. Only use this appliance indoors.

This appliance is intended for use up to a maximum height of 2000 metres above sea level.

This appliance is not intended for operation with an external clock timer or a remote control.

This appliance may be used by children over the age of 8 years old and by persons with reduced physical, sensory or mental capabilities or by persons with a lack of experience or knowledge if they are supervised or are instructed by a person responsible for their safety how to use the appliance safely and have understood the associated hazards.

Children must not play with, on, or around the appliance. Children must not clean the appliance or carry out general maintenance unless they are at least 15 years old and are being supervised.

Keep children below the age of 8 years old at a safe distance from the appliance and power cable.

Always slide accessories into the cooking compartment the right way round.

→ "Accessories" on page 10

Important safety information

General information

Warning – Risk of fire!

- Combustible items stored in the cooking compartment may catch fire. Never store combustible items in the cooking compartment. Never open the appliance door if there is smoke inside. Switch off the appliance and unplug it from the mains or switch off the circuit breaker in the fuse box.
- Loose food remnants, fat and meat juices may catch fire. Before using the appliance, remove the worst of the food remnants from the cooking compartment, heating elements and accessories.
- A draught is created when the appliance door is opened. Greaseproof paper may come into contact with the heating element and catch fire. Do not place greaseproof paper loosely over accessories during preheating. Always weight down the greaseproof paper with a dish or a baking tin. Only cover the surface required with greaseproof paper. Greaseproof paper must not protrude over the accessories.

Warning – Risk of burns!

- The appliance becomes very hot. Never touch the interior surfaces of the cooking compartment or the heating elements. Always allow the appliance to cool down. Keep children at a safe distance.
- Accessories and ovenware become very hot. Always use oven gloves to remove accessories or ovenware from the cooking compartment.
- Alcoholic vapours may catch fire in the hot cooking compartment. Never prepare food containing large quantities of drinks with a high alcohol content. Only use small quantities of drinks with a high alcohol content. Open the appliance door with care.
- The telescopic shelves become hot when the appliance is in use. Take special care not to get burnt when they are pulled out.

⚠ Warning – Risk of scalding!

- The accessible parts become hot during operation. Never touch the hot parts. Keep children at a safe distance.
- When you open the appliance door, hot steam can escape. Steam may not be visible, depending on its temperature. When opening, do not stand too close to the appliance. Open the appliance door carefully. Keep children away.
- Water in a hot cooking compartment may create hot steam. Never pour water into the cooking compartment when the cooking compartment is hot.

⚠ Warning – Risk of injury!

- Scratched glass in the appliance door may develop into a crack. Do not use a glass scraper, sharp or abrasive cleaning aids or detergents.
- The hinges on the appliance door move when opening and closing the door, and you may be trapped. Keep your hands away from the hinges.

⚠ Warning – Risk of electric shock!

- Incorrect repairs are dangerous. Repairs may only be carried out by one of our trained after-sales engineers. If the appliance is faulty, unplug the mains plug or switch off the fuse in the fuse box. Contact the after-sales service.
- The cable insulation on electrical appliances may melt when touching hot parts of the appliance. Never bring electrical appliance cables into contact with hot parts of the appliance.
- Do not use any high-pressure cleaners or steam cleaners, which can result in an electric shock.
- When replacing the cooking compartment bulb, the bulb socket contacts are live. Before replacing the bulb, unplug the appliance from the mains or switch off the circuit breaker in the fuse box.
- A defective appliance may cause electric shock. Never switch on a defective appliance. Unplug the appliance from the mains or switch off the circuit breaker in the fuse box. Contact the after-sales service.
- Do not use the appliance if the power cord and/or appliance are damaged. Call the after-sales service. If a fault occurs, pull the mains plug or switch off the mains voltage immediately.

Cleaning function**⚠ Warning – Risk of fire!**

- Loose food residues, grease and meat juices may catch fire during the cleaning function. Before starting the cleaning function, remove coarse dirt from the cooking compartment and from the accessories.
- The appliance will become very hot on the outside during the cleaning function. Never hang combustible objects, e.g. tea towels, on the door handle. Do not place anything against the front of the appliance. Keep children away from the appliance.
- If the door seal is damaged, a large amount of heat will be generated around the door. Do not scrub or remove the seal. Never operate the appliance if the seal is damaged or missing.

⚠ Warning – Risk of serious damage to health!

The appliance will become very hot during the cleaning function. The non-stick coating on baking trays and tins is destroyed and noxious gases are released. Never clean non-stick baking trays and baking tins using the cleaning function. Only clean enamelled accessories using the cleaning function.

⚠ Warning – Risk of harm to health!

The cleaning function heats up the cooking compartment to a very high temperature so that food remnants left over from roasting, grilling and baking will burn off. This process releases vapours, which can irritate the mucous membranes. While the cleaning function is running, keep the kitchen well ventilated. Do not remain in the room for long periods. Keep children and pets away. Follow the instructions even when using the Delayed start function with a delayed end time.

⚠ Warning – Risk of burns!

- The cooking compartment becomes extremely hot during the cleaning function. Never open the appliance door. Allow the appliance to cool down. Keep children away from the appliance.
- ⚠ The appliance becomes very hot on the outside during the cleaning function. Never touch the appliance door. Allow the appliance to cool down. Keep children at a safe distance.

Causes of damage

General information

Caution!

- Accessories, foil, greaseproof paper or ovenware on the cooking compartment floor: do not place accessories on the cooking compartment floor. Do not cover the cooking compartment floor with any sort of foil or greaseproof paper. Do not place ovenware on the cooking compartment floor if a temperature of over 50 °C has been set. This will cause heat to accumulate. The baking and roasting times will no longer be correct and the enamel will be damaged.
- Aluminium foil: Aluminium foil in the cooking compartment must not come into contact with the door glass. This could cause permanent discolouration of the door glass.
- Water in a hot cooking compartment: do not pour water into the cooking compartment when it is hot. This will cause steam. The temperature change can cause damage to the enamel.
- Moisture in the cooking compartment: Over an extended period of time, moisture in the cooking compartment may lead to corrosion. Allow the cooking compartment to dry after use. Do not keep moist food in the closed cooking compartment for extended periods of time. Do not store food in the cooking compartment.
- Cooling with the appliance door open: Following operation at high temperatures, only allow the cooking compartment to cool down with the door closed. Do not trap anything in the appliance door. Even if the door is only left open a crack, the front of nearby furniture may become damaged over time. Only leave the cooking compartment to dry with the door open if a lot of moisture was produced whilst the oven was operating.
- Fruit juice: when baking particularly juicy fruit pies, do not pack the baking tray too generously. Fruit juice dripping from the baking tray leaves stains that cannot be removed. If possible, use the deeper universal pan.
- Extremely dirty seal: If the seal is very dirty, the appliance door will no longer close properly during operation. The fronts of adjacent units could be damaged. Always keep the seal clean. Never operate the appliance if the seal is damaged or missing.
→ "Cleaning" on page 17
- Appliance door as a seat, shelf or worktop: Do not sit on the appliance door, or place or hang anything on it. Do not place any cookware or accessories on the appliance door.
- Inserting accessories: depending on the appliance model, accessories can scratch the door panel when closing the appliance door. Always insert the accessories into the cooking compartment as far as they will go.
- Carrying the appliance: do not carry or hold the appliance by the door handle. The door handle cannot support the weight of the appliance and could break.

Environmental protection

Your new appliance is particularly energy-efficient. Here you can find tips on how to save even more energy when using the appliance, and how to dispose of your appliance properly.

Saving energy

- Only preheat the appliance if this is specified in the recipe or in the tables in the operating instructions.
- Leave frozen food to defrost before placing it in the cooking compartment.

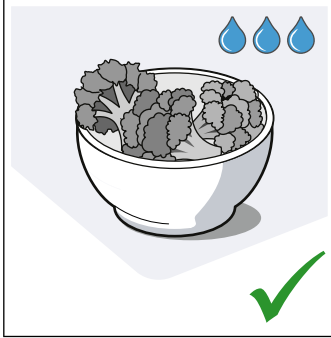
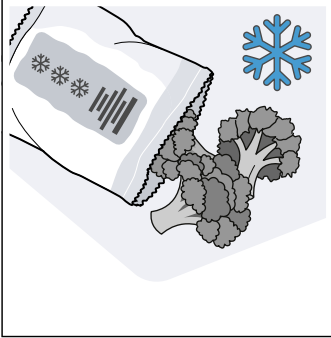

- Use baking tins that are dark-coloured, painted black or have an enamel coating. These absorb the heat particularly well.

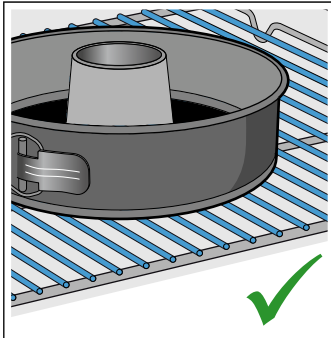
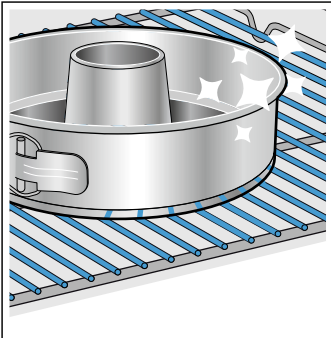

- Remove any unnecessary accessories from the cooking compartment.

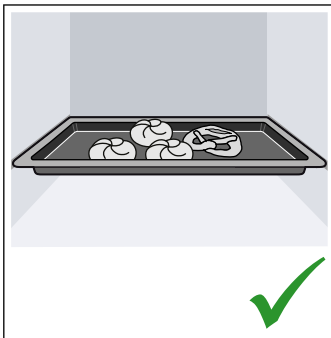
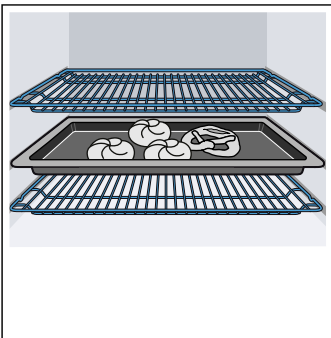

- Open the appliance door as infrequently as possible when the appliance is in use.

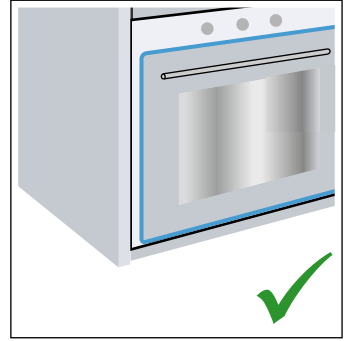
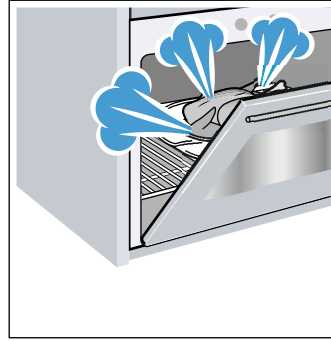

- It is best to bake several cakes one after the other. The cooking compartment stays warm. This reduces the baking time for the second cake. You can place two cake tins next to each other in the cooking compartment.

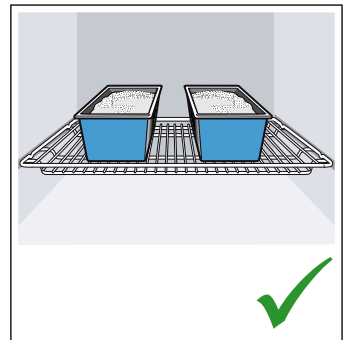
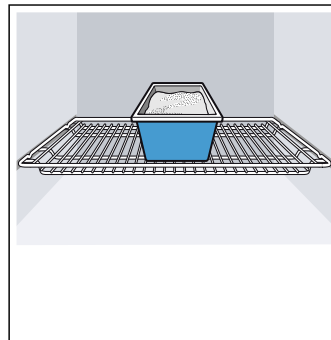

- For longer cooking times, you can switch the appliance off 10 minutes before the end of the cooking time and use the residual heat to finish cooking.

Environmentally-friendly disposal

Dispose of packaging in an environmentally-friendly manner.



This appliance is labelled in accordance with European Directive 2012/19/EU concerning used electrical and electronic appliances (waste electrical and electronic equipment - WEEE). The guideline determines the framework for the return and recycling of used appliances as applicable throughout the EU.

Getting to know your appliance

In this section, we will explain the indicators and controls. You will also find out about the various functions of your appliance.

Note: Depending on the appliance model, individual details and colours may differ.

Control panel

You can set your appliance's various functions on the control panel. Below, you will see an overview of the control panel and the layout of the controls.

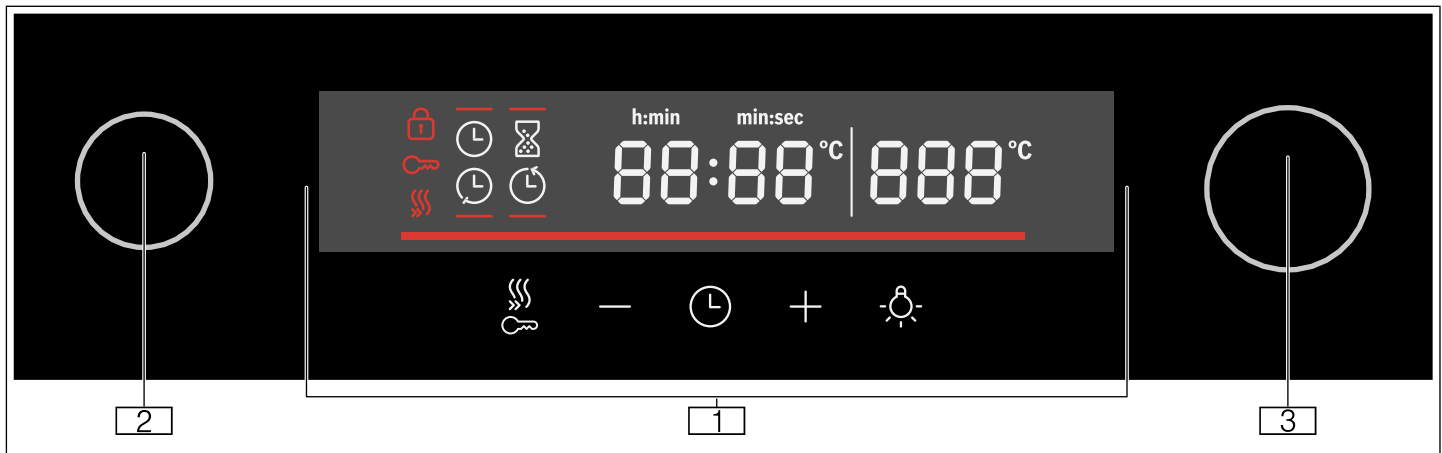

1 Buttons and display

The buttons are touch keys with sensors underneath. Simply touch a symbol to select the function.

The display shows symbols for active functions and the time-setting options.

2 Function selector

Use the function selector to set the heating function or other functions.

You can turn the function selector clockwise or anti-clockwise from the "Off" position.

3 Temperature selector

Use the temperature selector to set the temperature for the heating function or select the setting for other functions.

You can also turn the temperature selector clockwise or anti-clockwise. It does not have an "Off" position.

	Lighting	Switch the interior lighting on/off
	Rapid heat-up	Switch rapid heat-up on/off
	Childproof lock	Activate and deactivate the childproof lock in standby mode

Display

The display is structured so that the information can be read at a glance.

The value that you can currently set is in focus. It is displayed in white lettering with a dark background.

Symbol	Explanation
	Rapid heat-up
	Timer
	Duration
	End time
	Clock time
	Time
	Temperature indicator
	Childproof lock
	Door lock
	Temperature

Buttons

You will find a brief explanation of the various buttons below.













If a button is not operational, an audible signal will sound.

Button	Explanation
	Time-setting options Set the timer , duration , end time and clock time
	Minus Reduce the setting value
	Plus Increase the setting value

Types of heating and functions

Use the function selector to set the types of heating and other functions.

To make sure you always use the right type of heating to cook your food, we have explained the differences and applications below.

Heating function	Temperature/setting	Use
 "Off" position	-	In this position, the oven is switched off.
 3D hot air	50-280 °C	For cooking food on one or two levels. The fans distribute the heat from the ring-shaped heating elements in the back panel evenly around the cooking compartment.
 Air recirculation	50-280 °C	For baking cakes and baked items on one level. The fans distribute the heat from the heating elements evenly around the cooking compartment.
 Pizza setting	50-280 °C	For cooking fresh pizza and frozen products, e.g. chips or strudel. The heating elements and fans heat quickly and distribute the heat evenly around the cooking compartment.
 Defrosting	30-60 °C	For defrosting, e.g. meat, poultry, bread and cakes. The fan causes the warm air to circulate around the food.
 Bottom heating	50-280 °C	Use when you want to cook the food for a little longer. The heat is emitted only from below.
 Cleaning	Cleaning settings: 1 = low 2 = medium 3 = high	For running a cooking compartment self-cleaning programme.
 Full-surface grill	Grill settings: 1 = low 2 = medium 3 = high	For grilling flat items, such as steaks or sausages, for making toast, and for browning food. The whole area below the grill element becomes hot.
 Rotary spit	Grill settings: 1 = low 2 = medium 3 = high	Rotary spit: For roasts, rolled roasting joints and poultry
 Circulated air grill	50-280 °C	For baking or roasting meat, poultry and whole fish. The fan causes the hot air to circulate around the food.
 Gentle top/bottom heating	50-280 °C	For gently cooking selected types of food (e.g. meat, vegetables) on one level without preheating . This heating function is unsuitable for food that rises as it bakes (e.g. bread).
 Top/bottom heating	50-280 °C	For cakes, bakes and lean joints. Heat is emitted evenly from above and below.

Note: For each heating function, the appliance specifies a default temperature or level. You can accept this value or change it in the appropriate area.

Temperature selector

Use the temperature selector to set the temperature. The temperature that has been set will be shown on the display.

Note: The temperature can be set in 1 degree increments up to 100 °C, and in 5 degree increments thereafter.

Temperature indicator

The temperature indicator bars show the heating-up phases or residual heat in the cooking compartment.

Heating-up indicator	The heating-up indicator displays the rising temperature in the cooking compartment. When all bars are filled, the optimal time for placing the food in the oven has been reached. In the grill and cleaning settings, the bars are all already filled at the start. The bars are not filled for the gentle top/bottom heating heating type.
Residual heat indicator	When the appliance is switched off, the temperature indicator shows the residual heat in the cooking compartment. Once the temperature has dropped to approximately 60 °C, the indicator goes out.

Cooking compartment functions

Some functions make your appliance easier to use. This, for example, enables the cooking compartment to be well lit and a cooling fan to prevent the appliance from overheating.

Opening the appliance door

If you open the appliance door during an operation, the operation is paused. Operation continues to run when you close the door.

Interior lighting

When you open the appliance door, the interior lighting switches on. If the door remains open for longer than 15 minutes, the lighting switches off again.

In most operating modes, the interior lighting will switch on as soon as the appliance is started. Once the program is complete, the lighting will switch off.

Note: In "Top/bottom heating gentle" mode, the interior lighting will be switched off automatically after approx. 1 minute. It can be switched on using the  button.

Cooling fan

The cooling fan switches on and off as required. The warm air escapes above the door.

With the gentle top/bottom heating heating type, the cooling fan switches off and on more frequently to save energy.







Caution!

Do not cover the ventilation slots, Otherwise the oven will overheat.

To cool the cooking compartment more quickly after operation, the cooling fan continues to run for a certain period afterwards.

Accessories

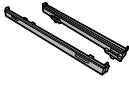
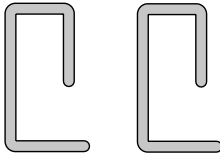
Your appliance is accompanied by a range of accessories. Here, you can find an overview of the accessories included and information on how to use them correctly.

Accessories	Description
	Baking and roasting shelf For cookware, cake tins, joints of meat, grilled items and frozen food.
	Wire insert Designed to be placed into the universal pan or the baking tray. For preparing large quantities of food.
	Universal pan For moist cakes, pastries, frozen meals and large roasts. The universal pan can be used to catch dripping fat when you are grilling directly on the wire rack.
	Enamel baking tray For tray bakes and small baked products.
	Telescopic rail set You can use the pull-out rails to pull the accessories out further.
	Locking pins For locking the hinges.
	Rotary spit For roasting joints of meat and large poultry. Use only in combination with the enamelled baking tray.

Shelf positions

The baking tray and the baking and roasting shelf can be moved into four different heights within the cooking compartment. Always insert them as far as they will go so that the accessories do not touch the door panel. Ensure that you always insert the accessories into the cooking compartment the right way round.

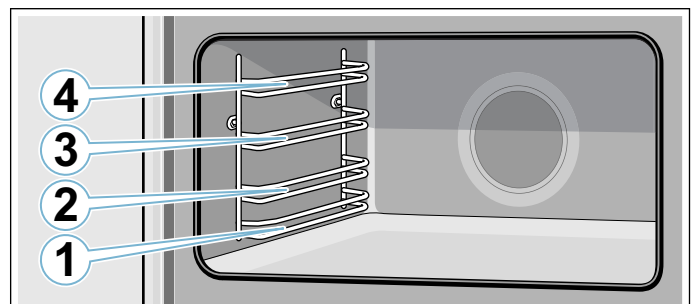

Warning – Risk of fire!

Under no circumstances should a roasting tin, baking tray, frying pan or any other form of cookware be placed directly on the oven floor. This causes the floor of the appliance to overheat and can seriously damage the appliance.

Locking function

The accessories can be pulled out approximately halfway before they lock in place. The locking function prevents the accessories from tilting when they are pulled out. The accessories must be inserted into the cooking compartment correctly for the tilt protection to work properly.

When inserting the wire rack, ensure that the lug **a** is at the rear and is facing downwards. The open side must be facing the appliance door and the curvature must be at the bottom (i.e. .

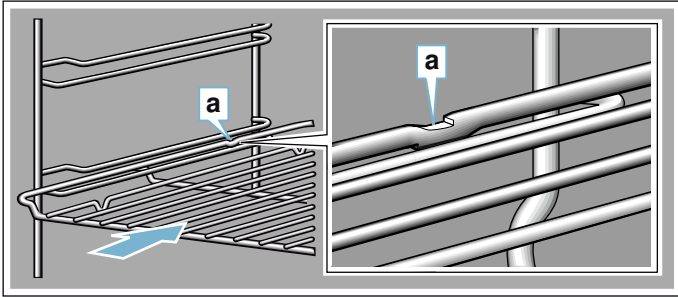

When inserting baking trays, ensure that the lug **a** is at the rear and is facing downwards. The sloping edge of the accessory **b** must be facing towards the appliance door.

Example in the picture: Universal pan

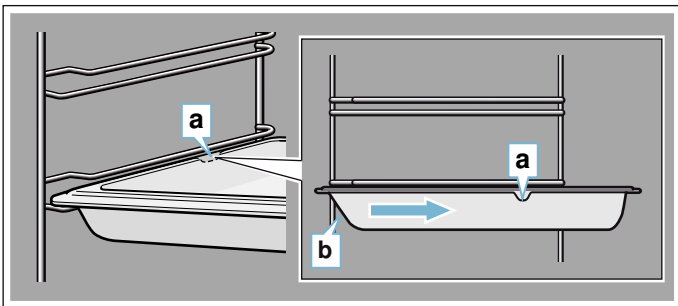

Telescopic rail set

Warning – Risk of burns!

The telescopic shelves become hot when the appliance is in use. Take special care not to get burnt when they are pulled out.

The pull-out rails allow you to pull accessories out completely. When inserting the adapter for the baking tray and roasting shelf, ensure that it locks into place in front of the tab on the pull-out rails.

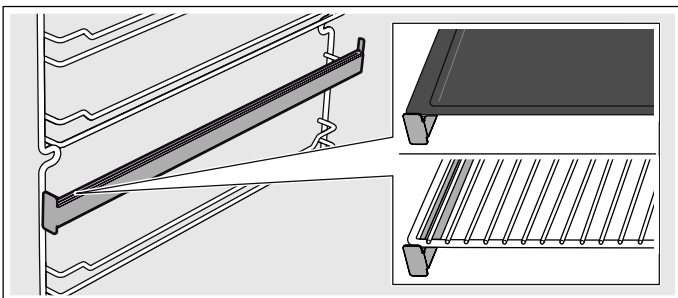

Special accessories

You can buy accessories from the after-sales service.

Accessories	Description
Enamelled baking tray	For tray bakes and small baked items. After-sales service number: 11012235
Universal pan	For moist cakes, pastries, frozen meals and large roasts. The universal pan can be used to catch dripping fat when you are grilling directly on the wire rack. After-sales service number: 11012236
Baking and roasting shelf	For cookware, cake tins, joints of meat, grilled items and frozen food. After-sales service number: 00776605
Telescopic shelf set	Telescopic shelf set for one level. After-sales service number: 12006236



Before using for the first time

In this section, you can find out what you must do before using your oven to prepare food for the first time.

Remove the appliance packaging and dispose of it appropriately.

Setting the time on the clock

Once the appliance is connected to a power supply, **12:00** will flash on the display and the ⌚ symbol will be continuously lit. Set the time.

1. Use the **-** or **+** button to set the time.
2. Press the ⌚ button.

Note: Once the period allowed for setting the clock time has elapsed, the clock time will automatically be saved.

The time has now been set.

Baking out the oven

Precleaning the oven

1. Remove the accessories and the shelf supports from the cooking compartment. → "Rails" on page 20
2. Completely remove any leftover packaging, e.g. small pieces of polystyrene, from the cooking compartment.
3. Some parts are covered with a protective film. Remove this scratch protection film.
4. Clean the outside of the appliance with a soft, damp cloth.
5. Clean the cooking compartment with hot soapy water.

Heating up the oven

To remove the new cooker smell, heat up the oven when it is empty and closed.

Note: Make sure that there is no leftover packaging, such as polystyrene pellets, in the cooking compartment. Before heating up the appliance, wipe the smooth surfaces in the cooking compartment with a soft, damp cloth. Keep the kitchen ventilated while the appliance is heating.

1. Turn the function selector to .
2. Turn the temperature selector to the maximum temperature.
3. Switch the oven off after 1 hour.

Note: When the appliance is heating up for the first time, you may hear crackling noises coming from the oven.

Recleaning the oven

1. Clean the cooking compartment with hot soapy water.
2. Refit the hook-in racks.
3. If necessary, clean the door panels. → "Appliance door" on page 20

Cleaning the accessories

Before using the accessories, clean them thoroughly using a cloth and warm soapy water.

Fitting the telescopic shelf set

Instructions on fitting the telescopic shelf set are enclosed with the set.

Operating the appliance

Switching the oven on and off

Switching on the oven

1. Use the function selector to set the heating function.
Note: Each function has a default temperature or grill setting.

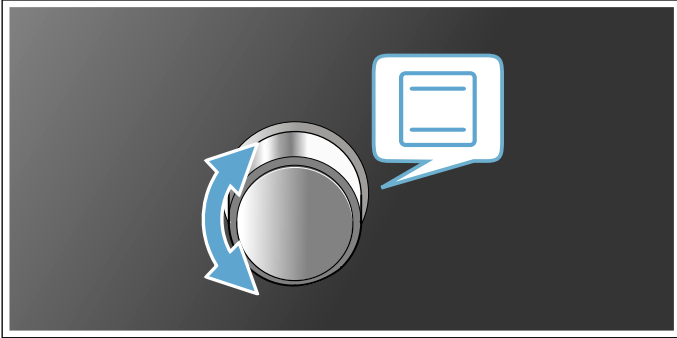

2. Use the temperature selector to alter the temperature or grill setting.

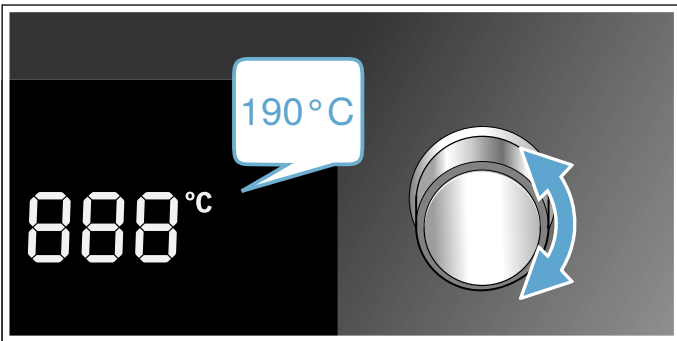

The oven will then begin to heat.

Note: The temperature indicator will show the current status of the heating-up phase.

Changing settings

The heating function and temperature or grill setting can be changed at any time using the relevant selector.

Switching off the oven

Turn the function selector to the "Off" position.

Switching on the rapid heat-up function

To heat up the cooking compartment as rapidly as possible, press the  button.

Note: Rapid heat-up is available for 3D hot air mode, air recirculation mode, the pizza setting and top/bottom heating.

Rotary spit

Preparing the rotary spit

1. Slide a retaining clip onto the rotary spit and screw on the handle.

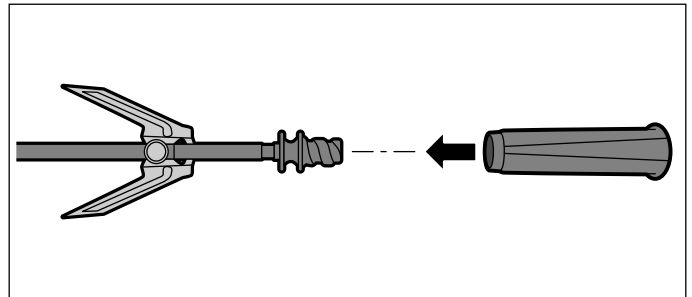

2. Place the roast as close as possible to the centre of the rotary spit.
3. Use retaining clips to secure the roast in place.
4. Use milled screws to secure the retaining clips.

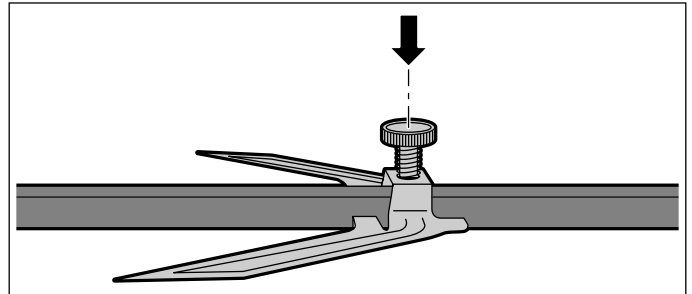

Inserting the rotary spit

Warning – Risk of burns!

Never touch the hot surfaces of the cooking compartment or the heating elements. Children must be kept at a safe distance from the appliance at all times. Open the appliance door carefully. Hot steam may escape.

1. Insert the rotary spit frame into the threaded bushes

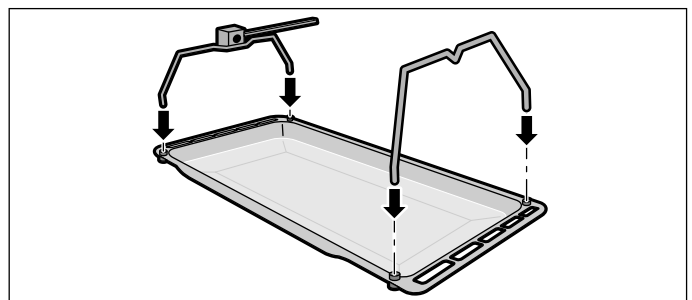

2. Place the rotary spit onto the rotary spit frame and unscrew the handle.

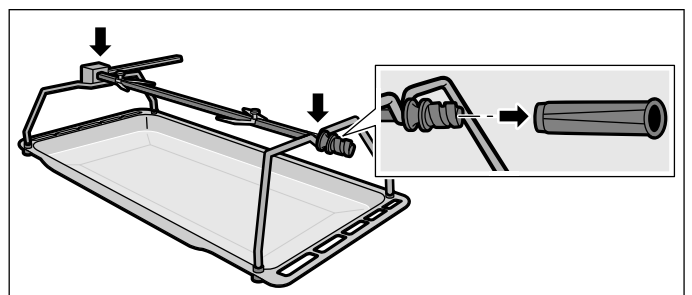

- Slide the universal pan into shelf position 1 and slide the rotary spit into the motor mount.

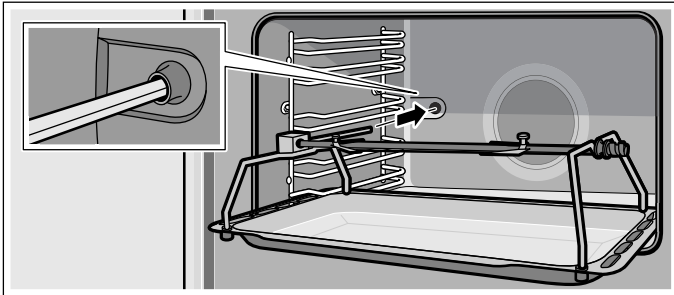

- Close the appliance door.

Switching on the rotary spit

Note: When using the rotisserie spit, heat the oven using the heating function. Insert the rotisserie spit before setting the heating function.

- Turn the function selector to .
- Set the grill setting.

Note: Pour some water into the universal pan to catch any fat that drips out.

Removing the rotary spit

Warning – Risk of burns!

Never touch the hot surfaces of the cooking compartment or the heating elements. Children must be kept at a safe distance from the appliance at all times. Open the appliance door carefully. Hot steam may escape.

- Opening the appliance door
- Slowly pull the universal pan until it is halfway out of the cooking compartment.
- Completely remove the universal pan from the cooking compartment and set it on the worktop.
- Screw on the handle and remove the grill spit from the grill spit frame.

Automatic safety switch-off function

The appliance has an automatic safety cut-out function. The oven switches off automatically after 13 hours.

Time-setting options

Your appliance has different time-setting options.

Overview of the time-setting options

Time-setting option	Use
Timer	The timer functions like an egg timer. It runs independently of the appliance when it is heating and of other time-setting options, and does not affect the appliance.
Clock time	When no other function is running in the foreground, the appliance will show you the time of day on the display.
Cooking time	Once the set cooking time has elapsed, the appliance will automatically stop heating.
End time	Enter a cooking time and the required end time. The appliance will start up automatically so that it finishes cooking at the required time.

Operating the electronic clock

Setting the timer

The timer has no effect on how the oven works. The timer duration can be set to between 30 seconds and 13 hours. The duration can be set in 30-second increments up to 10 minutes, in 1-minute increments from 10 minutes to 1 hour, and then in 5-minute increments.

- Press the button. The symbol will be lit.
- Use the **+** and **-** buttons to set the required duration. An audible signal will sound once the time has elapsed.

Notes

- To change the remaining time, press the button. Then change the remaining time using the **+** and **-** buttons.
- To stop the timer counting down, set the remaining time to zero.





Switching off the signal tone

To switch the signal off, press any button or open the appliance door.

Note: After a short time, the audible signal will stop automatically.

Setting the electronic clock

You can alter the clock if you need to (e.g. from summer to winter time). To do this, the oven must be switched off.



1. Press the  button.
The  symbol will be lit.
2. Press the  button again.
The  symbol will be lit.
3. Use the **+** and **-** buttons to set the current time.

Setting the automatic timer

The electronic clock can be used to switch the oven on or off automatically.

Setting the cooking time

You can set the cooking time for your food on the appliance. This prevents the food from accidentally being cooked for too long, and means that you do not have to stop what you are doing to switch off the oven.

1. Set the type of heating and the temperature you require.
The oven will start.
2. Press the  button twice.
3. Use the **+** and **-** buttons to set the required cooking time.
Note: The cooking time can be set to between 30 seconds and 13 hours. The cooking time can be set in 1-minute increments up to 1 hour, and then in 5-minute increments.
The  symbol will be lit.





The cooking time has elapsed

An audible signal will sound. The appliance will stop heating.

1. To switch the signal off, press any button or open the appliance door.
Note: After a short time, the audible signal will stop automatically.
2. Turn the function selector to the "Off" position.

Setting the end time

Baking or roasting starts for the set duration at a later time which you chose.

1. Set the type of heating and the temperature you require.
The oven will start.
2. Press the  button twice.
3. Use the **+** and **-** buttons to set the required cooking time.
Note: The cooking time can be set to between 30 seconds and 13 hours. The cooking time can be set in 1-minute increments up to 1 hour, and then in 5-minute increments.
The  symbol will be lit.
4. Press the  button again.
5. Use the **+** and **-** buttons to set the end time.
Note: When the button is first pressed, a value will be suggested on the display. This suggested value is calculated using the current time on the clock and the cooking time. This value can be changed using the **+** and **-** buttons.
The  symbol will be lit. The display will show the end time. The appliance will now switch to standby mode.

The cooking time has elapsed

An audible signal will sound. The appliance will stop heating.

1. To switch the signal off, press any button or open the appliance door.
Note: After a short time, the audible signal will stop automatically.
2. Turn the function selector to the "Off" position.

Childproof lock

The oven has a childproof lock to prevent children from switching it on by accident.

Note: If the hob is being used, it will not be affected by the childproof lock on the oven.

Activating the childproof lock

The appliance must be switched off.

Press and hold the  button for approx. 4 seconds.

The  symbol will appear on the display. The childproof lock has now been activated.

Deactivating the childproof lock

Press and hold the  button for approx. 4 seconds.

The  symbol will go out on the display. The childproof lock has now been deactivated.

Basic settings

There are various settings available to you in order to help use your appliance effectively and simply. You can change these settings as required.

List of basic settings



Depending on the features of your appliance, not all basic settings will be available.

Basic setting	Options
c01 Audible signal duration upon completion of a cooking time or timer duration	1 = approx. 10 seconds 2 = approx. 30 seconds* 3 = approx. 2 minutes
c02 Amount of time until a setting is applied	1 = approx. 3 seconds* 2 = approx. 6 seconds 3 = approx. 10 seconds
c03 Button tone that sounds when a button is touched	0 = off 1 = on*
c04 Brightness of the display illumination	1 = dark 2 = medium* 3 = bright
c05 Display time of day	0 = hide the time 1 = display the time*
c06 Interior lighting on when appliance in operation	0 = no 1 = yes*
c07 Cooling fan run-on time	1 = short* 2 = medium 3 = long 4 = extra long
c08 Reset all values to factory settings	0 = no* 1 = yes
c09 Activate demo mode Demo mode is provided for demonstration purposes only; the oven does not actually heat in Demo mode. Demo mode can only be activated within 5 minutes of connecting the appliance to the mains power supply.	0 = no* 1 = yes

* Factory setting

Changing the basic settings

The function selector must be set to the "Off" position.

1. Press and hold the  button for approx. 4 seconds. The first basic setting will appear on the display, e.g. .
2. Use the temperature selector to change the setting as required.
3. Use the **+** button to navigate to the next basic setting.
4. Use the **-** or **+** button to continue going through all the basic settings as described above, and use the temperature selector if you want to change any of these settings.
5. When you have finished, press and hold the  button again for approx. 4 seconds to confirm the settings. This applies all the basic settings.

You can change the basic settings again at any time. Demo mode can only be activated within 5 minutes of connecting the appliance to the mains power supply.

Note: Your changes to the basic settings will be retained even after a power failure.

Setting energy-saving mode

You can save energy by reducing the display brightness. You can set the display brightness under basic setting .

Note: This setting changes the brightness of the display while the appliance is in operation. In standby mode, the appliance automatically reduces the display brightness. The display is at its dimmest at night, between the hours of 22:00 and 05:59.

Cleaning

With good care and cleaning, your appliance will retain its appearance and remain fully functioning for a long time to come. We will explain here how you should correctly care for and clean your appliance.

Warning – Risk of electric shock!

Do not use any high-pressure cleaners or steam cleaners, which can result in an electric shock.

Warning – Risk of burns!

The appliance becomes very hot. Never touch the interior surfaces of the cooking compartment or the heating elements. Always allow the appliance to cool down. Keep children at a safe distance.

Suitable cleaning agents

Observe the following information to ensure that the different surfaces are not damaged by using the wrong type of cleaning agent.

Do not use any of the following

on the oven:

- Any harsh or abrasive cleaning agents,
- Cleaning agents with a high concentration of alcohol,
- Hard scouring pads or sponges,
- High-pressure cleaners or steam cleaners.

Wash new sponge cloths thoroughly before use.

Area	Cleaning
Appliance exterior	
Stainless steel front	Hot soapy water: Clean with a dish cloth and then dry with a soft cloth. Remove flecks of limescale, grease, starch and albumin (e.g. egg white) immediately. Corrosion can form under such flecks. Special stainless steel cleaning products suitable for hot surfaces are available from our after-sales service or from specialist retailers. Apply a very thin layer of the cleaning product with a soft cloth.
Control panel	Hot soapy water: Clean with a dish cloth and then dry with a soft cloth. Do not use glass cleaner or a glass scraper.
Door panels	Hot soapy water: Clean with a dish cloth and then dry with a soft cloth. Do not use a glass scraper or a stainless steel scouring pad.
Door handle	Hot soapy water: Clean with a dish cloth and then dry with a soft cloth. If descaler comes into contact with the door handle, wipe it off immediately. Otherwise, any stains will not be able to be removed.
Appliance interior	

Enamelled surfaces	<p>Hot soapy water or a vinegar solution: Clean with a dish cloth and then dry with a soft cloth.</p> <p>Soften baked-on food remnants with a damp cloth and soapy water. Use stainless steel wire wool or oven cleaner to remove stubborn dirt.</p> <p>Caution!</p> <p>Never use oven cleaner in the cooking compartment when it is still warm. This may damage the enamel. Remove all food remnants from the cooking compartment and the appliance door before you next heat up the appliance.</p> <p>Leave the cooking compartment open to dry after cleaning it.</p> <p>It is best to use the cleaning function. → "Cleaning function" on page 19</p> <p>Note: Food residues can cause white deposits to form. These are harmless and do not affect how the appliance works. Remove using lemon juice if required.</p>
Glass cover for the interior lighting	<p>Hot soapy water: Clean with a dish cloth and then dry with a soft cloth.</p> <p>If the cooking compartment is heavily soiled, use oven cleaner.</p>
Door panels	<p>Hot soapy water: Clean with a dish cloth and dry with a soft cloth.</p> <p>Do not use a glass scraper or a stainless steel scouring pad.</p> <p>It is best to clean the door panels along with the rest of the cooking compartment. → "Cleaning the cooking compartment" on page 18</p>
Door seal Do not remove.	<p>Hot soapy water: Clean with a dish cloth. Do not scour.</p>
Door cover	<p>made from stainless steel: Use stainless steel cleaner. Follow the manufacturers' instructions. Do not use stainless steel care products.</p> <p>made from plastic: Clean using hot soapy water and a dish cloth. Dry with a soft cloth. Do not use glass cleaner or a glass scraper. Remove the door cover for cleaning.</p>
Rails	<p>Hot soapy water: Soak and clean with a dish cloth or brush.</p>
Pull-out system	<p>Hot soapy water: Clean with a dish cloth or a brush.</p> <p>Do not remove the lubricant while the pull-out rails are pulled out – it is best to clean them when they are pushed in. Do not clean in the dishwasher.</p>

Accessories	<p>Hot soapy water: Soak and clean with a dish cloth or brush. If there are heavy deposits of dirt, use a stainless steel scouring pad.</p>
-------------	---

Notes

- Slight differences in colour on the front of the appliance are caused by the use of different materials, such as glass, plastic and metal.
- Shadows on the door panels, which look like streaks, are caused by reflections made by the interior lighting.
- Enamel is baked on at very high temperatures. This can cause some slight colour variation. This is normal and does not affect operation.
The edges of thin trays cannot be completely enamelled. As a result, these edges can be rough. This does not impair the anti-corrosion protection.

Keeping the appliance clean

Always keep the appliance clean and remove dirt immediately so that stubborn deposits of dirt do not build up.

⚠ Warning – Risk of fire!

Loose food remnants, fat and meat juices may catch fire. Before using the appliance, remove the worst of the food remnants from the cooking compartment, heating elements and accessories.

Tips

- Clean the cooking compartment after each use. This will ensure that dirt cannot be baked on.
- Always remove flecks of limescale, grease, starch and albumin (e.g. egg white) immediately.
- Use the universal pan for baking very moist cakes.
- Use suitable ovenware for roasting, e.g. a roasting dish.

Cleaning the cooking compartment

1. Pour 0.4 litres of water into the centre of the cooking compartment floor.
2. Set the heating function.
3. Use the temperature controller to set a temperature of 50 °C.
4. Switch off the appliance after 18 minutes.
5. Allow the appliance to cool down.
6. Clean the cooking compartment with a cloth.

⚠ Warning – Risk of burns!

The appliance becomes very hot. Never touch the interior surfaces of the cooking compartment or the heating elements. Always allow the appliance to cool down. Keep children at a safe distance.

Cleaning function

Your appliance has a self-cleaning function. You can use the self-cleaning function to clean the cooking compartment.

Pyrolytic self-cleaning

You can use "Pyrolytic self-cleaning" mode to clean the cooking compartment with no effort at all. The cooking compartment is heated up to a very high temperature. Residues from roasting, grilling and baking will burn.

Running this cleaning programme requires approximately 5-10 kilowatt hours, depending on the time set. The cleaning programme can be set to run for between 2 hours 30 minutes and 3 hours 30 minutes.

Note: For your safety, the cooking compartment door locks automatically. It cannot be opened again until the lock indicator light  goes out. The interior lighting remains off while the appliance is being cleaned.

Warning – Risk of serious damage to health!

The appliance will become very hot during the cleaning function. The non-stick coating on baking trays and tins is destroyed and noxious gases are released. Never clean non-stick baking trays and baking tins using the cleaning function. Only clean enamelled accessories using the cleaning function.

Warning – Risk of burns!

- The cooking compartment becomes extremely hot during the cleaning function. Never open the appliance door. Allow the appliance to cool down. Keep children away from the appliance.
-  The appliance becomes very hot on the outside during the cleaning function. Never touch the appliance door. Allow the appliance to cool down. Keep children at a safe distance.
- The appliance becomes very hot. Never touch the interior surfaces of the cooking compartment or the heating elements. Always allow the appliance to cool down. Keep children at a safe distance.

Before running the cleaning function

Caution!

Shelf supports and pull-out rails get damaged if they are left in the cooking compartment when it is cleaned. Before you start the cleaning function, remove the shelf supports and pull-out rails from the cooking compartment.

1. Remove the shelf supports and pull-out rails from the cooking compartment.
2. Remove the worst of the food residues and remnants from the cooking compartment.
3. Clean the inside of the appliance door and along the edges of the cooking compartment in the area around the seal. Do not scrub the seal.

Warning – Risk of fire!



- Loose food remnants, fat and meat juices may catch fire when the cleaning function is in progress. Before you start the cleaning function, always remove the worst of the food residues and remnants from the cooking compartment.
- The appliance will become very hot on the outside during the cleaning function. Never hang combustible objects, e.g. tea towels, on the door handle. Do not place anything against the front of the appliance. Keep children away from the appliance.

Starting

1. Turn the function selector to the  heating function.
2. Use the temperature selector to set a cleaning setting.

Cleaning setting	Duration
1	2 hours 30 minutes
2	3 hours
3	3 hours 30 minutes

Note: Moving the function selector while the cleaning cycle is in progress will stop the pyrolytic self-cleaning program.

One minute after the cleaning cycle (pyrolytic self-cleaning) has begun, the oven door is locked to prevent it from being opened. The indicator light  lights up to show that this door lock has been activated. Once the door lock has been activated, it is no longer possible to select any functions. To select functions, wait until the  indicator light goes out.

Note: You can continue to use the timer while the pyrolytic self-cleaning program is in progress. The duration you set will have no effect on the pyrolytic self-cleaning function.

Note: You will not be able to use the interior lighting while the pyrolytic self-cleaning programme is in progress.

Cancelling

To cancel a programme, turn the function selector to the "Off" position.

Ending

Once the self-cleaning function has run through to the end, an audible signal will sound. The appliance door cannot be opened until the  symbol goes out.

Once the cleaning function has ended

Once the cooking compartment has cooled down, use a damp cloth to wipe off the ash that has been left behind in the cooking compartment and around the appliance door.

Note: Very bad soiling may cause white deposits to remain on the enamel surfaces. This is residue from the food and is harmless. It does not affect performance. You can remove these residues using lemon juice if required.

Rails

Detaching the shelf supports

The shelf supports are each fixed to the side panels of the cooking compartment at three points.

1. Grip the front of the shelf support and pull it round to the middle of the cooking compartment. The front hook of the shelf support will come out of the hole.
2. Swing the shelf support round further and pull it out of the rear holes in the side panel.
3. Remove the shelf supports from the cooking compartment.

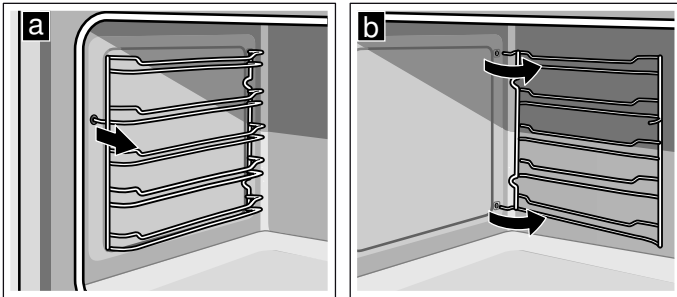

Refitting the shelf supports

1. Insert the hooks of the shelf support into the rear holes in the side panel.
2. Push the front hook of the shelf support into the hole.

Appliance door

With good care and cleaning, your appliance will retain its appearance and remain fully functional for a long time to come. This will tell you how to clean the appliance door.

Removing and installing the door panels

To facilitate cleaning, you can remove the glass panels from the oven door.

Removing the door panels

1. Open the oven door fully.
2. Lock the two hinges on the left and right using the locking pin.

Note: The locking pins must be fully inserted into the holes in the hinges.

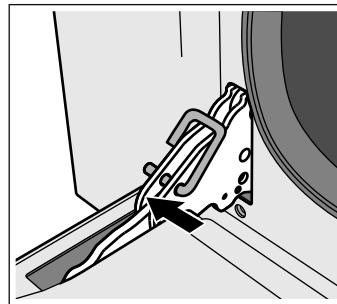

3. Use both hands to lift the bottom of the inner panel until the fastening pins come out of the holder.
4. Carefully pull the top of the inner panel out of the retaining strip and lift it to completely free the panel from the door.

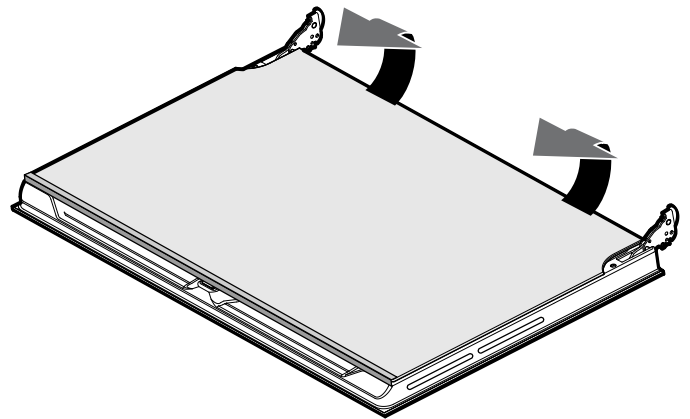

- Remove the two middle panels, along with their holders.

Note: The two middle panels are not fastened using retaining pins; instead, they are held in place using holders.

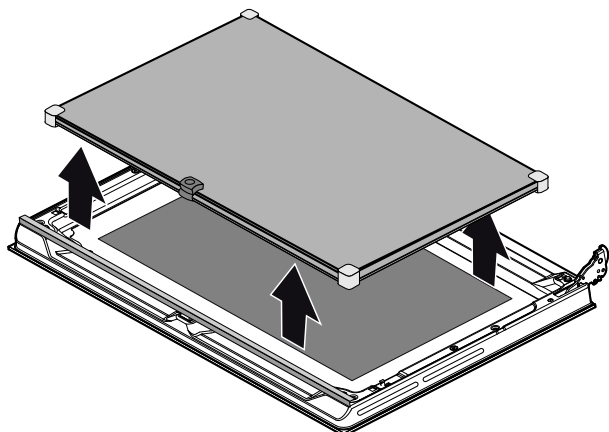

- Remove the holders to separate the two middle panels from one another.
- Clean the panels with glass cleaner and a soft cloth.

⚠ Warning – Risk of injury!

Scratched glass in the appliance door may develop into a crack. Do not use a glass scraper, sharp or abrasive cleaning aids or detergents.

Fitting the door panels

- Reinsert the two middle panels.

Notes

- You will know that you have inserted the two middle panels correctly when you can see the "Low-E" symbol on both panels.
- Make sure that the panels are seated correctly. All holders must lay flat against the outer panel.

- Reinsert the inner panel.

Note: The panel must first be inserted into the retaining bar. The two fastening pins must then engage in the holders provided for them.

- Remove the locking pins and close the oven door.

Removing and fitting the appliance door

If the oven is very heavily soiled, the oven door can be removed for easier cleaning. Normally, however, this is not necessary.

Removing the appliance door

- Open the oven door fully.
- Lock the two hinges on the left and right using the locking pin (a).

Note: The locking pins must be fully inserted into the holes in the hinges.

- Take hold of the sides of the oven door with both hands and close the oven door by approx. 30° (b).

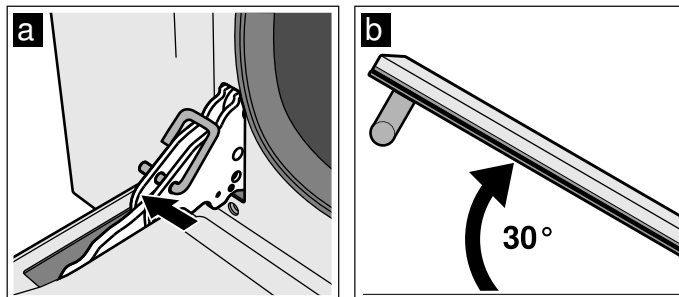

- Lift the oven door slightly and pull it out.
Note: Do not close the oven door fully, otherwise the hinges could become bent and the enamel could be damaged.

Fitting the appliance door

- Take hold of the sides of the oven door with both hands.
- Slide the hinges into the slots in the oven (a).
Note: The notch at the bottom of the hinges must engage into the frame of the oven (b).

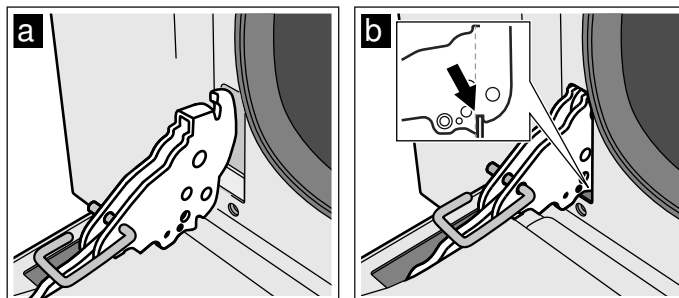

- Lower the door.
- Remove the locking pins.





⚠ Warning – Risk of injury!

If the oven door falls out accidentally or a hinge snaps shut, do not reach into the hinge. Call the after-sales service.

⚠ Warning – Risk of injury!

The door may not close properly if the door hinges have not engaged correctly. This will allow heat to escape and the parts of the appliance may become very hot. To prevent this from happening, remove the door again. Then refit the door as shown in the drawing, making sure that the groove on the underside of the hinges engages in the oven frame.

Trouble shooting

Fault	Possible cause	Notes/remedy
The appliance does not work	The plug is not plugged into the mains	Connect the appliance to the power supply
	Power cut	Check whether other kitchen appliances are working
	The circuit breaker is faulty	Check in the fuse box to make sure that the fuse for the appliance is OK
The appliance cannot be started	The appliance door is not fully closed	Close the appliance door
	The appliance is not switched off	Switch the appliance off and back on again
12:00 is flashing on the display	Power failure	Reset the clock.
The interior lighting is not working	Gentle top/bottom heating mode is active	In gentle top/bottom heating mode, the interior lighting is not switched on.
	The bulb is faulty	Replace the bulb.
All food that is cooked in the oven burns within an extremely short period of time.	Thermostat faulty.	Call the after-sales service.
Door panels are steamed up.	This is normal and results from differences in temperature.	Heat the appliance up to 100 °C and then switch it back off after 5 minutes.
Although the appliance is switched on, it cannot be operated; the  symbol is shown on the display	The childproof lock is activated.	Press and hold the  touch button until the  symbol goes out.
The appliance door will not open; the  symbol is shown on the display	The appliance door remains locked until the cooking compartment has cooled down.	Wait until the  symbol goes out

Fault messages

If a fault message beginning with *Err* appears on the display, set the function selector to "Off". If the fault message does not disappear, please contact our after-sales service.

Fault message	Possible cause	Information/remedy
<i>Err1</i>	Temperature sensor failed.	Call the after-sales service.
<i>Err2</i>	The temperature in the cooking compartment is too high.	Call the after-sales service.
<i>Err4</i>	Door locking mechanism incorrectly activated.	Call the after-sales service.
<i>Err5</i>	Fan heating element faulty or not connected.	Call the after-sales service.
<i>Err6</i>	Motor faulty or not connected.	Call the after-sales service.
<i>Err8</i>	Cooling fan faulty or not connected.	Call the after-sales service.

Replacing the oven light bulb

If the oven light bulb fails, it must be replaced. Replacement heat-resistant bulbs can be obtained from the after-sales service or from specialist retailers. Please specify the E number and FD number of your appliance. Do not use any other type of bulb.

⚠ Warning – Risk of electric shock!

When replacing the cooking compartment bulb, the bulb socket contacts are live. Before replacing the bulb, unplug the appliance from the mains or switch off the circuit breaker in the fuse box.

1. Allow the cooking compartment to cool down.
2. Open the appliance door.
3. Place a tea towel in the cooking compartment to prevent damage.
4. Remove the shelf supports.
5. Remove the glass cover. To do this, open the glass cover from the front with your hand. Should you experience difficulties removing the glass cover, use a spoon to help you.
6. Remove the oven light bulb.

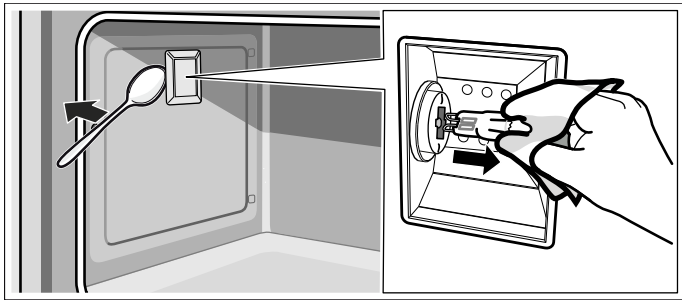

7. Replace the oven light bulb with a bulb of the same type:
Voltage: 230 V;
Power: 40 W;
Fitting: G9;
Temperature resistance: 300 °C
8. Refit the glass cover for the oven light bulb.
9. Refit the shelf supports.
10. Remove the tea towel.
11. Switch the circuit breaker back on.
12. Check that the oven lighting is working again.

Technical Data

Power supply: 220-240 V~ 50 Hz

Max. total connected load: 3300 W

Customer service

Our after-sales service is there for you if your appliance needs to be repaired. We will always find an appropriate solution, also in order to avoid after-sales personnel having to make unnecessary visits.

E number and FD number

When calling us, please quote the full product number (E no.) and the production number (FD no.) so that we can provide you with the correct advice. The rating plate bearing these numbers can be found when you open the appliance door.

On some appliances with a steam-assisted cooking function, you will find the rating plate behind the control panel.

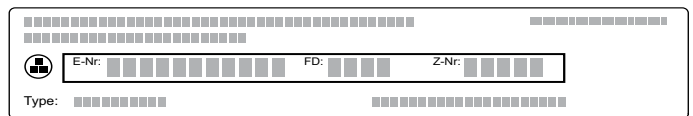

To save time, you can make a note of the numbers for your appliance and the telephone number of the after-sales service in the space below in case you need them.

E no.	FD no.	
After-sales service 		

Please note that a visit from an after-sales service engineer is not free of charge in the event that the appliance has been misused, even during the warranty period.

Please find the contact data of all countries in the enclosed customer service list.

To book an engineer visit and product advice

CN 400 885 5888

Call rates depend on the network used.

Rely on the professionalism of the manufacturer. You can therefore be sure that the repair is carried out by trained service technicians who carry original spare parts for your appliances.

Distributor and origin information:

Place of origin: Italy

Chief Distributor: BSH Home Appliances (China) Co., Ltd.

Address: 20/F, 21/F, CN International Mansion, No. 129 Zhongshan Road, Nanjing

Standards conform to:

GB 4706.1-2005 Safety of household and similar electrical appliances: General requirements



























GB 4706.22-2008 Safety of household and similar electrical appliances - Particular requirements for stationed stoves, stoves, ovens and similar appliances

Tested for you in our cooking studio

Here, you can find a selection of dishes and the ideal settings for them. We will show you which type of heating and temperature are best suited to your dish. You will get information on suitable cooking accessories and the height at which they should be placed in the oven. You will also get tips about cookware and preparation methods.

Note: A lot of steam can build up in the cooking compartment when cooking food. Your appliance is very energy-efficient and radiates very little heat to its surroundings during operation. Due to the high difference in temperature between the appliance interior and the external parts of the appliance, condensation may build up on the door, control panel or adjacent kitchen cabinet panels. This is a normal physical phenomenon. Condensation can be reduced by preheating the oven or opening the door carefully.

Table of dishes

Dish	Weight (in kg)	Shelf position	Heating function	Temperature in °C	Cooking time in minutes
Lasagne	3-4	1		220-230*	45-50
Pasta bake	3-4	1		220-230*	45-50
Joint of veal	2	2		180-190*	90-100
Pork loin	1.5-2	2		190-200*	90-100
Pork loin	2	2		200**	125
Sausages	1.5	3		280*	First side: 10 Second side: 7
Roast beef	1	2		200*	45-55
Roast rabbit	1.5	2		180-190*	70-80
Turkey breast	2	2		180-190*	110-120
Pork neck joint	2-3	2		180-190*	170-180
Roast chicken	1.2	2		190-200*	65-70
Pork chops	1.5	3		280*	First side: 15 Second side: 5
Spare ribs	1.5	3		280*	First side: 15 Second side: 10
Bacon	0.7	4		3*	First side: 10 Second side: 8
Fillet of pork	1.5	3		280*	First side: 12 Second side: 5
Fillet of beef	1	4		3*	First side: 7 Second side: 4
Large rainbow trout	0.7-1.2	2		160-170*	35-40
Monkfish	0.7-1.5	2		160*	60-65
Turbot	1.5	2		160*	45-50
Pizza	1-1.5	2		280*	10-12
Bread	1	2		180-190*	25-30
Focaccia	1	2		180-190*	20-25
Bundt cake	1	2		160*	55-60
Fruit flan	1	2		160*	35-40
Cheesecake	1	2		160-170*	45-55
Short-crust pastry	1	2		160-170*	35-40
Short-crust pastry	1	2		170**	65

* Preheat

** Do not preheat

Dish	Weight (in kg)	Shelf position	Heating function	Temperature in °C	Cooking time in minutes
Parfait cake	1.2	2		160*	55-60
Cream puffs	0.7-1.2	2		180*	50-60
Sponge cake	1	2		150-160*	55-60
Rice pudding	1	2		160*	55-60
Brioche	1-1.2	2		160*	30-35

* Preheat
** Do not preheat

Tips for using your appliance

Here you will find a selection of tips on ovenware and preparation methods.

Notes

- Use the accessories provided. Additional accessories may be obtained as special accessories from specialist retailers or from the after-sales service. Before using the oven, remove any unnecessary accessories and ovenware from the cooking compartment.
- Always use an oven cloth or oven gloves when taking accessories or cookware out of the cooking compartment.

Baking tips

You want to find out whether the cake is completely cooked in the middle.	Push a cocktail stick into the highest point on the cake. If the cocktail stick comes out clean with no dough residue, the cake is ready.
The cake collapses.	Next time, use less liquid. Alternatively, set the temperature to be 10 °C lower and extend the baking time. Adhere to the specified ingredients and preparation instructions in the recipe.
The cake has risen in the middle but is lower around the edge.	Only grease the base of the springform cake tin. After baking, loosen the cake carefully with a knife.
The fruit juice overflows.	Next time, use the universal pan.
Small baked items stick to one another during baking.	There should be a gap of approx. 2 cm around each item. This gives enough space for the baked items to expand well and brown on all sides.
The cake is too dry.	Set the temperature 10 °C higher and shorten the baking time.
The cake is generally too light in colour.	If the shelf position and the cookware are correct, then you should increase the temperature if necessary or extend the baking time.
The cake is too light on top, and too dark underneath.	Bake the cake one level higher in the oven the next time.
The cake is too dark on top, and too light underneath.	Bake the cake one level lower in the oven the next time. Select a lower temperature and extend the baking time.
Cakes baked in a tray or tin are too brown at the back.	Place the baking tray in the middle of the accessories, not directly against the back wall.
The whole cake is too dark.	Select a lower temperature next time and extend the baking time if necessary.
The cake is unevenly browned.	Select a slightly lower temperature. Protruding greaseproof paper can affect the air circulation. Always cut greaseproof paper to size. Ensure that the baking tin does not stand directly in front of the openings in the cooking compartment back wall. When baking small items, you should use similar sizes and thicknesses wherever possible.
You were baking on several levels. The items on the top baking tray are darker than those on the lower baking tray.	Always select hot air when baking on several levels. Baked items that are placed into the oven on trays or in baking tins/dishes at the same time will not necessarily be ready at the same time.

The cake looks good, but is not cooked properly in the middle.	Use a lower temperature and bake slightly longer; if necessary, add slightly less liquid. For cakes with a moist topping, bake the base first. Sprinkle it with almonds or breadcrumbs and then place the topping on top.
The cake cannot be turned out of the dish when it is turned upside down.	Allow the cake to cool down for 5 to 10 minutes after baking. If it still sticks, carefully loosen the cake around the edges again using a knife. Turn the cake tin upside down again and cover it several times with a cold, wet cloth. Next time, grease the baking tin/dish and sprinkle with breadcrumbs.

Tips for Roasting and Braising

The roast is too dark and the crackling is burned in places, and/or the roast is too dry.	Check the shelf position and temperature. Select a lower temperature the next time and reduce the roasting time if necessary.
The crackling is too thin.	Increase the temperature or switch on the grill briefly at the end of the roasting time.
The roast looks good but the juices are burnt.	Next time, use a smaller roasting dish and add more liquid if necessary.
The roast looks good but the juices are too clear and watery.	Next time, use a larger roasting dish and add less liquid if necessary.
The meat gets burned during braising.	The roasting dish and lid must fit together well and close properly. Reduce the temperature and add more liquid when braising if necessary.

Acrylamide in foodstuffs

Acrylamide is mainly produced in grain and potato products prepared at high temperatures, such as potato crisps, chips, sliced bread, bread rolls, bread or fine baked goods (biscuits, gingerbread, spiced biscuit).

Tips for keeping acrylamide to a minimum	
General	<ul style="list-style-type: none"> ■ Keep cooking times as short as possible. ■ Cook food until it is golden brown, but not too dark. ■ Large, thick pieces of food contain less acrylamide.
Baking	With top/bottom heating at max. 200 °C. With hot air at max. 180 °C.
Biscuits	With top/bottom heating at max. 190 °C. With hot air at max. 170 °C. Egg or egg yolk reduces the production of acrylamide.
Oven chips	Spread out a single layer evenly on the baking tray. Cook at least 400 g at once on a baking tray so that the chips do not dry out.

目录

 主要用途	28	 清洁	38
 重要安全信息	28	合适的清洁剂	38
常规信息	28	保持电器清洁	39
清洁功能	29	清洁烹饪箱	39
 损坏原因	29	 清洁功能	39
常规信息	29	高温分解模式	39
 环境保护	30	 导轨	40
节能	30	拆卸烤架支架	40
环保处理	30	重新安装烤架支架	40
 了解您的电器	31	 电器门	41
控制面板	31	拆除和安装门面板	41
按键	31	拆卸和安装电器门	41
显示屏	31	 故障检修	42
加热类型和功能	32	故障消息	42
温度选择钮	32	更换烤箱灯泡	42
烹饪箱功能	32	 客户服务	43
 附件	33	E 编号和 FD 编号	43
烹饪层	33	经销商及原产地信息	43
锁定功能	33	 经由我们烹饪工作室测试过的菜谱	44
伸缩式轨道装置	33	菜谱	44
专用附件	33	电器使用提示	45
 首次使用之前	34		
设置时钟时间	34		
使用烤箱烘焙	34		
清洁附件	34		
安装伸缩架套装	34		
 操作电器	34		
打开和关断烤箱	34		
旋转烤叉	35		
自动安全关断功能	35		
 时间设置选项	36		
时间设置选项一览	36		
操作电子钟	36		
设置自动定时器	36		
 儿童锁	37		
激活儿童锁	37		
取消激活儿童锁	37		
 基本设置	37		
基本设置列表	37		
更改基本设置	37		
设置节能模式	38		

关于产品、附件、更换部件以及服务的更多信息请参见 www.bosch-home.com 和在线商店 www.bosch-eshop.com

主要用途

请认真阅读本手册。只有这样才能安全正确地使用电器。请保管好说明手册和安装说明，以备日后使用或供下一任所有者使用。

本电器仅适合整体安装在厨房内。请遵守专用的安装说明。

拆开包装后请检查电器是否有损坏。如果电器在运输过程中损坏，请勿连接电器。

仅限持有上岗证书的专业人员才可以连接不带插头的电器。因不正确连接导致的损坏将不予保修。

本电器仅供家庭使用。本电器只能用于制备食物和饮料。电器工作时必须有人看管。本电器仅限室内使用。

本电器最高可在海拔 2000 米的高度使用。

本电器不适合用外部定时器或遥控器操作。

8 岁以上儿童以及身体、感官或精神有缺陷的人员或缺乏相关经验和知识的人员，必须在有人监督的情况下或在其安全责任人给予电器使用安全指导并了解相关危险的情况下，方可使用本电器。

严禁儿童玩耍本电器及在电器周围玩耍。儿童除非年满 15 岁并有人监督，否则不得清洁本电器或执行一般维护操作。

8 岁以下儿童请远离本电器和电源线。

必须将附件滑入烹饪箱最里面。→ "附件" 第 33 页

重要安全信息

常规信息

警告 - 有着火危险!

- 易燃物品保存在烹饪箱中可能导致着火危险。切勿将易燃的物品保存在烹饪箱中。切勿在内部起烟时打开电器门。关断电器，拔下电源插头，或关断熔断器盒中的断路器。
- 松散的食物残渣、脂肪和肉汁可能会着火。在首次使用电器制备食物之前，去除烹饪箱、加热元件和附件上的食物残余物。
- 电器门打开时会产生一股气流。防油纸可能会与加热元件接触并着火。在预热期间，切勿将防油纸散铺在附件上。请务必用烤盘或烤模压住防油纸。防油纸应仅覆盖需要覆盖的表面。切勿伸出附件。

警告 - 有灼伤危险! !

- 电器会变灼热。切勿触摸烹饪箱的内表面或加热元件。必须让电器冷却下来。请将小孩留在安全距离以外。
- 附件和烹饪容器会变得十分灼热。从烹饪箱中取出附件或烹饪容器时必须戴上烤箱手套。
- 酒精蒸汽可能会在热烹饪箱内着火。切勿烹饪混合了大量高浓度酒类的食物。只能使用少量高浓度酒类。打开电器门时需小心。
- 当设备在使用时，伸缩架子会变得灼热。抽出时千万小心，避免灼伤。

警告 - 有烫伤危险!

- 可接触的部位在使用期间可能会变得很烫。切勿触碰灼热部位。请将小孩留在安全距离以外。
- 在打开电器门时，可能会有热蒸汽逸出。由于温度原因，蒸汽可能不可见。开门时，不要站得离电器太近。打开电器门时要小心。不要让儿童靠近。
- 将水倒入高温烹饪箱会产生热蒸汽。切勿将水倒入高温烹饪箱中。

警告 - 有受伤危险!

- 电器门玻璃如果有刮伤，可能会导致裂开。请不要使用玻璃刮刀、剧烈或腐蚀性的清洁用品或洗涤剂。
- 电器门上的铰链会在开、关门时移动，您可能会被夹住。双手必须远离铰链。

⚠ 警告 – 有电击危险!

- 修理不当是很危险的。只能由我公司派出的经过培训的售后工程师进行修理。如果电器有故障，拔下电源插头或断开保险丝盒中的保险丝。联系售后服务部门。
- 如果接触到电器的灼热部件，电器的电线绝缘层会熔化。切勿使电器电源线接触电器的灼热部件。
- 请勿使用高压清洁器或蒸汽清洁器，以防触电。
- 更换烹饪箱灯泡时，灯泡插座触点是带电的。更换灯泡前，拔下电器电源插头或断开熔断器盒中的断路器。
- 故障电器会导致电击危险。切勿接通发生故障的电器。拔下电器的电源插头或断开保险丝盒中的断路器。联系售后服务部门。
- 若本电器或电源线遭到破坏，请勿强行使用，请联系售后，发生故障时，请立即拔除电源插头或关闭电源电压。

清洁功能**⚠ 警告 – 有着火危险!**

- 在清洁循环期间，松散的食物碎屑、油脂和肉汁可能会着火。在开始清洁循环之前，请先清除烹饪箱和附件中的严重污垢。
- 在清洁循环期间，电器外壁将变得灼热。切勿在门把手上悬挂易燃物品，例如毛巾。切勿紧靠电器正面放置任何物品。让儿童远离本电器。
- 门密封件损坏时，门区域会泄漏出大量热量。该密封件不得磨损，不得拆下。密封件损坏或缺失时，不得运行该设备。

⚠ 警告 – 有严重损害健康的危险!

在清洁循环期间，电器将变得灼热。烤盘和烤模上的不粘涂层被损坏，会释放出有毒气体。切勿使用清洁功能来清洁不粘烤盘或烤模。只可使用清洁功能清洁搪瓷附件。

⚠ 警告 – 存在有害健康的危险!

清洁功能会将烹饪室加热至极高温，以至于烤制、烧烤和烘培残余物会烧焦。此时会释放出蒸汽，可能会刺激粘膜。在清洁功能运行期间，为厨房大量通风。不要长时间逗留在房间内。让儿童和宠物远离。即使对于延迟运行模式下推后的结束时间，也要遵照说明。

⚠ 警告 – 有灼伤危险!

- 在清洁循环期间，烹饪箱将变得灼热。请勿打开电器门。让电器冷却下来。让儿童远离本电器。
- ⚠ 在清洁循环期间，电器外壁将变得灼热。切勿触摸电器门。让电器冷却下来。让儿童远离本电器。

损坏原因**常规信息****注意!**

- 烹饪箱箱底上的附件、薄膜、防油纸或烹饪容器：请勿将附件放置在烹饪箱箱底上。不要将任何薄膜或防油纸铺在烹饪箱箱底上。如果将温度设置在 50 °C 以上，则不要将烹饪容器放在烹饪箱箱底上。这将导致热量积聚。烤制时间将不再准确，同时会损坏搪瓷。
- 铝箔：烹饪箱内的铝箔不得与门玻璃接触。否则会导致门玻璃永久褪色。
- 高温烹饪箱中的水：切勿将水倒入高温烹饪箱中。这将产生蒸汽。温度剧变可能导致搪瓷损坏。
- 烹饪箱中的水分：烹饪箱中长期有水分可能会导致腐蚀。让烹饪箱在使用后充分干燥。不要将潮湿的食物长期存放在密闭的烹饪箱内。不要将食物存储在烹饪箱内。
- 打开电器门进行冷却：高温操作之后，烹饪箱必须关门冷却。不要将任何东西夹在电器门中。否则，即使电器门只是略微开启，长时间下来，附近的橱柜表面也可能损坏。如果烤箱运行时产生大量水分，则只能打开电器门让烹饪箱干燥。
- 果汁：在烘焙汁水特别丰富的水果派时，烤盘中不要装得过满。因果汁从烤盘上滴落而留下的污渍很难清除。如有可能，请使用深底普通烤盘。
- 门封极为脏污：如果门封非常脏，电器门在操作过程中将无法正确关闭。附近橱柜的表面可能会损坏。应始终保持门封清洁。密封件损坏或缺失时，不得运行该设备。→ "清洁"第 38 页
- 把电器门当作座椅、搁架或工作台：请勿坐在电器门上，也不要放在电器门上放置或悬挂任何物品。不要将任何烹饪容器或附件放在电器门上。
- 插入附件：根据电器型号，在关闭电器门时，附件可能会刮伤门板。将附件插入烹饪箱时使其尽可能靠里。
- 搬运电器：不要抓着门把手搬运电器。门把手不能承受电器的重量，可能会断开。

环境保护

您的新电器属于特别节能款。您可以在本章节找到关于在使用电器时如何节约更多能源和如何正确处置报废电器的提示。

节能

- 仅在菜谱有要求或操作说明表中有明确指示的情况下才预热电器。
- 放入烹饪箱之前让冷冻食物解冻

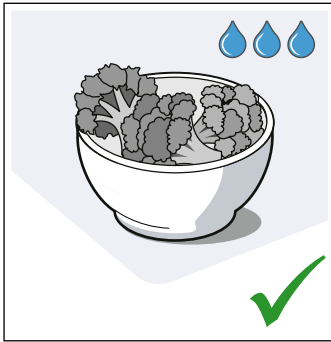
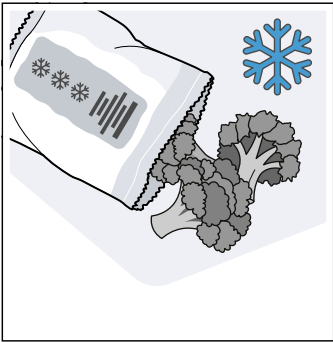

- 使用深色黑漆或者具有搪瓷涂膜的烤模。吸热效果会特别好。

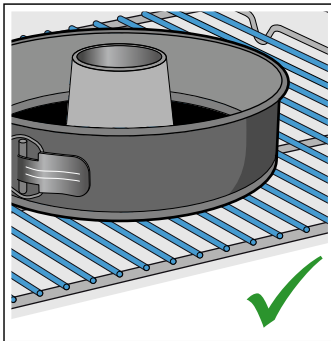
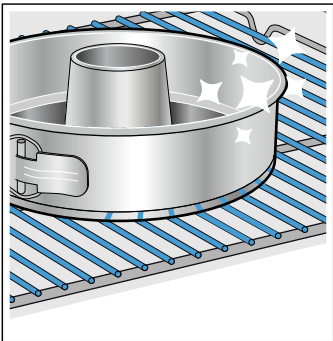

- 从烹饪箱中取出不必要的附件。

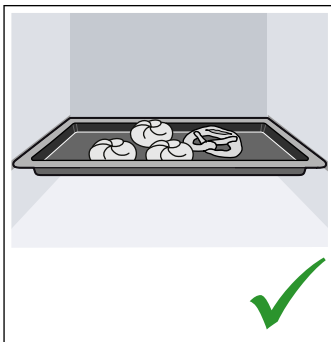
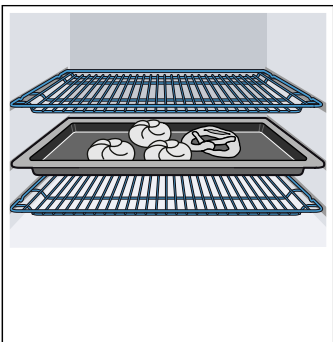

- 在烹饪食物时，尽可能不要频繁地打开电器门。

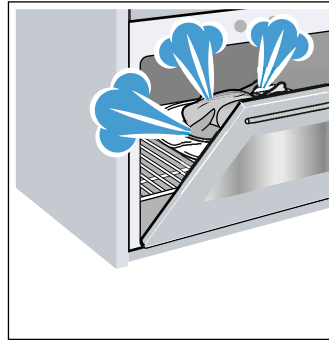

- 烤制多份糕点时最好一份接一份地烤。令烹饪箱留有余温。这可减少第二份糕点的烤制时间。您可以将两个蛋糕模挨着放在烹饪箱中。

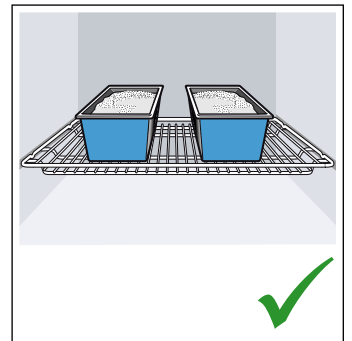
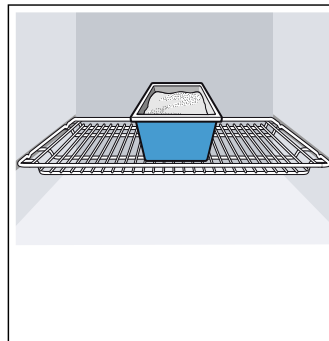

- 对于长时间的烹饪，您可以在烹饪时间结束前 10 分钟关断烤箱，用剩余的热量完成烹饪。

环保处理

按照环保要求处理包装材料。



本电器已经根据欧盟有关废弃电气和电子设备的法令2012/19/EU (waste electrical and electronic equipment - WEEE)进行了标记。该指令是在全欧盟范围内关于废弃设备回收处理和再生利用的有效法律依据。

了解您的电器

本节对指示符和控件进行说明。此外，您还会了解到电器的各种功能。

提示: 根据电器型号，个别细节和颜色可能不同。

控制面板

您可以在控制面板上设置电器的各种功能。下面是控制面板总览和控件布局。

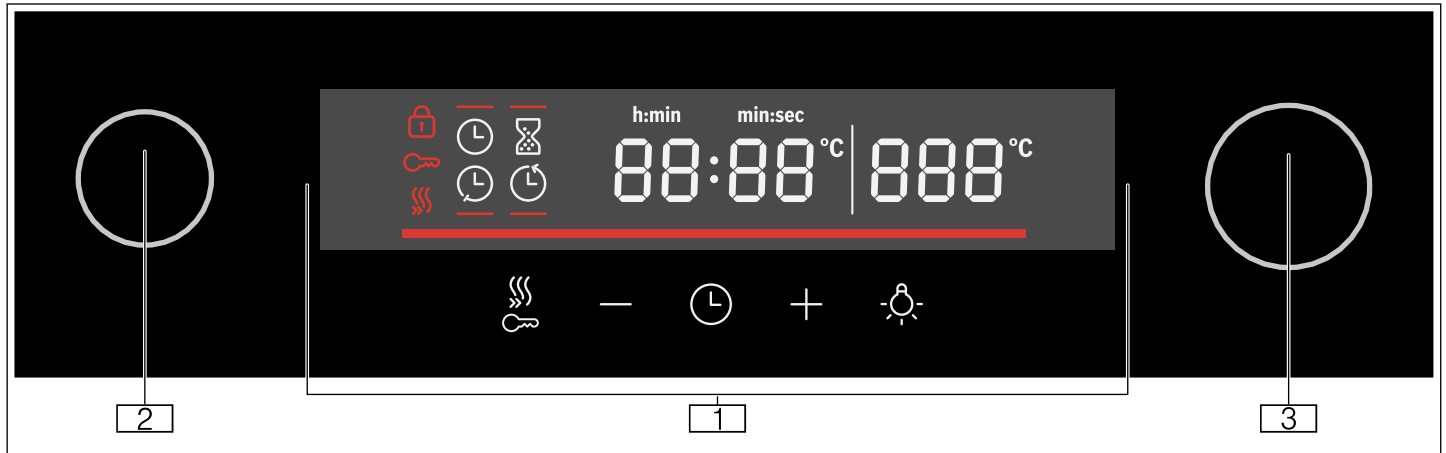

- 1 **按键和显示屏**
按钮是下方带传感器的触摸键。只需触摸符号即可选择它所代表的功能。
显示屏显示激活的功能所对应的符号以及时间设置选项。
- 2 **功能选择钮**
使用功能选择钮设置加热功能和其它功能。
可从“关”位置顺时针或逆时针转动功能选择钮。
- 3 **温度选择旋钮**
使用温度选择钮可设置加热功能的温度或选择其他功能的相关设置。
还可以顺时针和逆时针转动温度选择钮。没有“Off”（关）位置。

按键

您可以在下文中找到有关各个按键的简短说明。
如果按键不动作，信号音响起。

按键	说明
⌚	时间设置选项 设置定时器 ⏰、持续时间 ⌚、结束时间 ⌚ 和时钟时间 ⌚
-	减 减小设置值
+	加 增大设置值
💡	照明 开启/关断内部照明
🔥	快速预热 关断/开启快速预热
🔒	儿童锁 在待机模式下启用/停用儿童锁

显示屏

显示屏结构鲜明，所示信息一目了然。
当前可以设置的值重点显示。即以深色背景白色字体显示。

符号	说明
🔥	快速预热
⏰	定时器
⌚	持续时间
⌚	结束时间
⌚	时钟
88:88	时间
-----	温度指示器
🔒	儿童锁
🔒	门锁
888	温度

加热类型和功能

使用功能选择钮设置加热类型和其它功能。

确保始终使用正确的加热类型烹饪食物，关于它们的差异及其应用请参见下文说明。

加热功能	温度/设置	用途
○ “关”位置	-	在该位置下，电器关断。
3D 热风	50-280 °C	用于在一层或两层上烹饪食物。风扇将来自后壁的加热圈的热量均匀分配到烹饪箱各处。
空气循环	50-280 °C	用于在同一层烘焙和烘烤。风扇将来自加热元件的热量均匀分配到烹饪箱各处。
匹萨设置	50-280 °C	用于烹饪新鲜匹萨和冷冻食物。加热元件和风扇快速加热并将热量均匀分配到烹饪箱各处。
解冻	30-60 °C	用于解冻，用于肉类、家禽、面包和蛋糕。风扇使温热的空气在食物周围流通。
底部加热	50-280 °C	在希望略微延长食物烹饪时间的情况下使用。热量仅从下方散发。
清洁	清洁设置: 1 = 低火 2 = 中火 3 = 高火	用于运行烹饪箱自清洁程序。
大面积烧烤	烧烤设置: 1 = 低火 2 = 中火 3 = 高火	用于烧烤扁平食物，如肉排、香肠或面包及红烧食物。烧烤元件下面的整个区域变热。
旋转烤叉	烧烤设置: 1 = 低火 2 = 中火 3 = 高火	旋转烤叉：用于烤肉、烤肉卷和家禽
热风烧烤	50-280 °C	用于烤制肉类、家禽和全鱼。风扇使热空气在食物周围流通。
顶部/底部温和加热	50-280 °C	用于在 无预热 情况下在单层上温和烹饪所选择的食物类型(如肉、蔬菜等)。该加热功能不适用于受热膨胀的食物(如面包)。
顶部/底部加热	50-280 °C	用于烤制蛋糕、饼干和瘦肉块。热量从上、下均匀散发。

提示: 对于每种加热类型，电器会指定默认温度或等级。您可以接受该值或进行适当更改。

温度选择钮

用温度选择钮设置温度。所设置的温度将出现在显示屏中。

提示: 温度可以按 1 °C 的增量进行设置，达到 100 °C 后按 5 °C 的增量进行设置。

温度指示器

温度指示器光柱显示加热阶段或烹饪箱中的余热。

加热指示器	加热指示器显示烹饪箱中不断升高的温度。当所有光柱都填满的时候就是将菜肴放入烤箱的最佳时刻。 在烧烤和清洁设置下，光柱在启动时就已经填满。 光柱在顶部/底部温和加热类型下不填充。
余热指示器	当电器关闭时，温度指示器显示的是烹饪箱中的余热。只要温度下降到 60 °C 左右，指示器就熄灭。

烹饪箱功能

某些功能可使您的电器更易于使用。例如，这可使烹饪箱内更加明亮，而冷却风扇则可防止电器过热。

打开电器门

如果在操作期间打开电器门，则操作暂停。操作将在关上门后继续运行。

内部照明

当您打开电器门时，内部照明将打开。如果在 15 分钟以后门仍然打开，照明再次关断。

在大多数操作模式下，只要打开电器，内部照明亮起。程序结束后，照明将关断。

提示: 在“顶部/底部温和加热”模式下，内部照明将在大约 1 分钟后自动关闭。可使用 按键将其打开。

冷却风扇

冷却风扇按要求开启和关断。暖空气从门上方逸出。

使用顶部/底部温和加热类型时，冷却风扇关闭、打开更为频繁，从而节约能量。

注意!

不要盖住通风槽，否则，烤箱将过热。

为了在操作后更快地冷却烹饪箱，冷却风扇将在操作后继续运行一段时间。

附件

电器随附一系列附件。您可以在本章节找到有关随附附件的概览以及正确使用附件的信息。

附件	描述
	烘焙和烧烤架 用于烤箱器皿、烤模、烤肉、烧烤和冷冻食品。
	插入式烤架 设计用于放在普通烤盘或烤盘中。用于制备大量食物。
	通用烤盘 用于烤制松软的蛋糕、糕点、冷冻食品和大块烤肉。直接在烤架上烤肉时，可以用通用盘子收集滴下的油脂。
	烤盘 用于制作烤盘蛋糕和小点心。
	伸缩式轨道装置 您可以使用拉出式导轨将附件进一步拉出。
	锁针 锁住铰链。
	旋转烤叉 用于烤制肉块和大型家禽。仅与搪瓷烤盘同时使用。

烹饪层

烤盘和烤架可以放置在烤箱内的四个高度上。尽量插入最里面，以免附件碰到门板。必须将附件插入烹饪箱最里面。

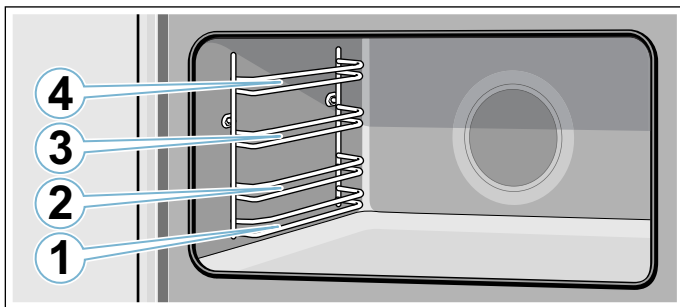

警告 - 有着火危险!

在任何情况下，烤模、烤盘或其他烹饪容器都不得直接放在烤箱底板上。这导致电器底板过热，可能会严重损坏电器。

锁定功能

在卡到位之前，附件可以抽出一半。锁定功能防止附件在拉出时发生倾斜。附件必须正确插入烹饪箱内才能确保防倾斜保护功能正常发挥作用。

插入烤架时，确保凸耳 **a** 位于后方且朝下。打开侧必须面向电器门，弯曲部分必须在下方 (即 )。

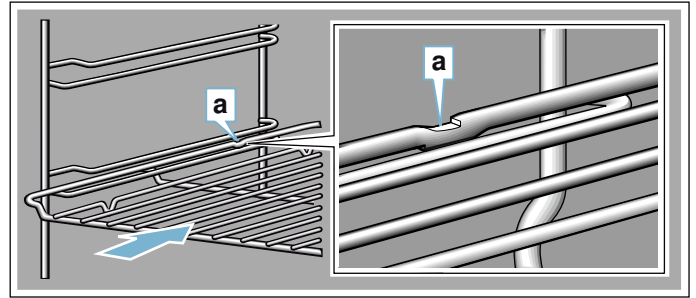

插入烤盘时，确保凸耳 **a** 位于后方且朝下。附件 **b** 的倾斜边缘必须朝向电器门。

图中实例：普通烤盘

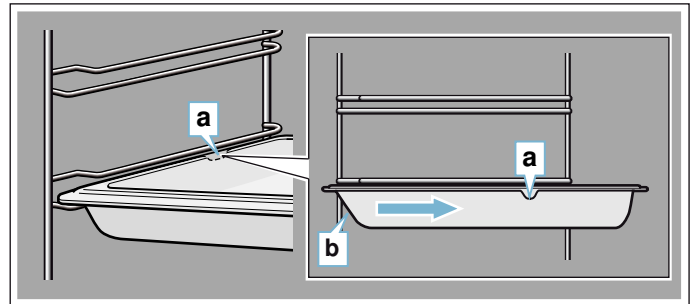

伸缩式轨道装置

警告 - 有灼伤危险!

当设备在使用时，伸缩架子会变得灼热。抽出时千万小心，避免灼伤。

您可以使用拉出式导轨将附件完全拉出。当插入烤盘和烤架底座时，确保其卡入拉出式导轨上的凸耳的前方。

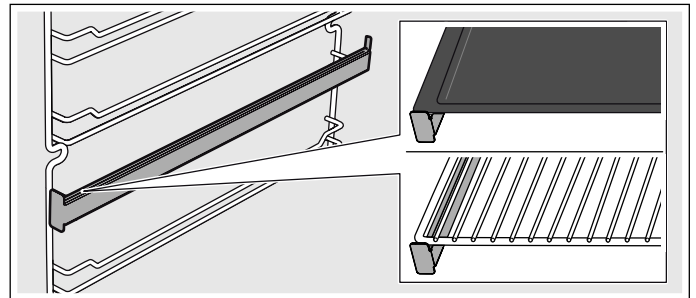

专用附件

可以从售后服务部购买附件。

附件	描述
搪瓷烤盘	用于制作烤盘蛋糕和小点心。 售后服务订货号：11012235
通用烤盘	用于烤制松软的蛋糕、糕点、冷冻食品和大块烤肉。 直接在烤架上烤肉时，可以用通用盘子收集滴下的油脂。 售后服务订货号：11012236
烘焙和烤架	用于烤箱器皿、烤模、烤肉、烧烤和冷冻食品。 售后服务订货号：00776605
伸缩架套装	用于一层的伸缩架套装 售后服务订货号：12006236

首次使用之前

在本节中，您可以查看在第一次使用烤箱制备食物之前必须要做的事。

取出电器包装并妥善处置。

设置时钟时间

电器接通电源后，**12:00** 将在显示屏上闪烁，⌚ 符号将持续点亮。设置时间。

1. 使用 **-** 或 **+** 按键设置时间。
2. 按下 ⌚ 按键。

提示：允许的时钟设置时间到后，时钟时间将自动保存。

时间已经设置好了。

使用烤箱烘焙

预先清洁烤箱

1. 从烹饪箱中取出附件和烤架支架。→ "导轨"第 40 页
2. 从烹饪箱中取出遗留的包装，例如聚苯乙烯颗粒。
3. 某些部件有一层保护膜。撕下保护膜。
4. 用柔软的湿布擦拭电器的外部。
5. 用热肥皂水清洁烹饪箱。

加热烤箱

为了去除新炊具的味道，可清空、关闭烤箱，进行加热。

提示：确保烹饪箱中没有遗留包装物品，例如聚苯乙烯颗粒。在加热电器之前，请用柔软的湿布擦拭烹饪箱中的光滑表面。电器加热时保持厨房通风。

1. 将功能选择钮旋转至  位置。
2. 转动温度选择钮，设置最高温度。
3. 1 小时后关断烤箱。

提示：第一次加热烤箱时，可能会听到劈啪声。

预先清洁烤箱

1. 用热肥皂水清洁烹饪箱。
2. 重新安装钩入式烤架。
3. 必要时请清洁门面板。→ "电器门"第 41 页

清洁附件

在使用附件前，请用布和温肥皂水彻底清洁附件。

安装伸缩架套装

安装伸缩架套装说明随套装提供。

操作电器

打开和关断烤箱

开启烤箱

1. 将功能选择钮设置到所需的加热功能。
提示：每种功能都有默认温度或烧烤设置。

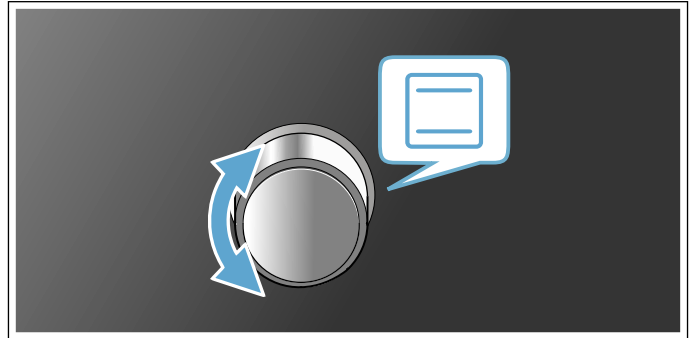

2. 使用温度选择钮改变温度或烧烤设置。



烤箱将开始加热。

提示：温度指示器显示加热阶段的当前状态。

更改设置

可使用相关旋钮随时更改加热功能和温度或烧烤设置。

关断烤箱

将功能选择钮转到“关”位置。

打开快速加热功能

为了尽快加热烹饪箱，按下  按键。

提示：在 3D 热风、热风循环、匹萨设置和顶部/底部加热模式下可以使用快速加热。

旋转烤叉

准备旋转烤叉

1. 将固定架装在旋转烤叉上，拧上把手。

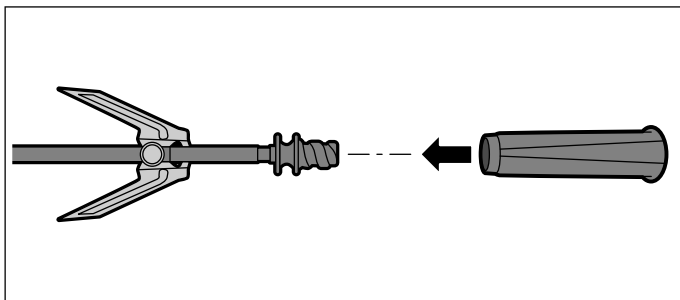

2. 尽量将烤肉靠近烤肉叉的中央放置。
3. 使用固定夹将烤肉固定到位。
4. 使用滚花螺丝拧紧固定夹。

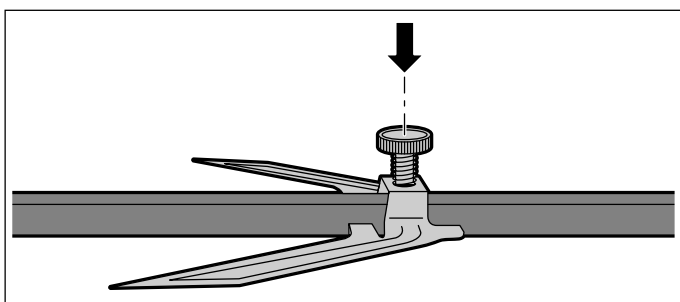

插入旋转烤叉

⚠ 警告 – 有灼伤危险!

切勿触摸烹饪箱的灼热表面或加热元件。务必将小孩留在电器安全距离以外。打开电器门时要小心。可能会有热蒸汽逸出。

1. 将旋转烤箱架插入螺纹套管中

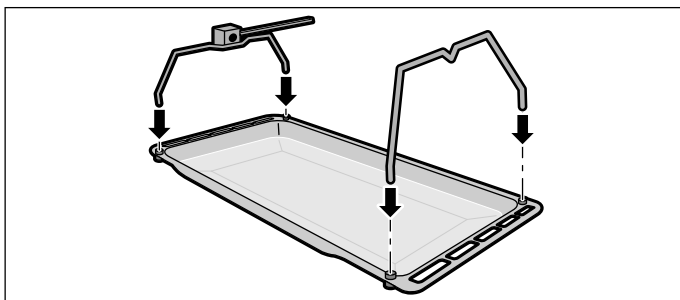

2. 将旋转烤叉放在旋转烤叉架上，拧开把手螺丝。

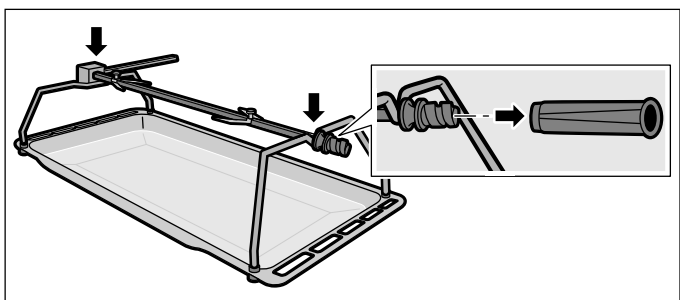

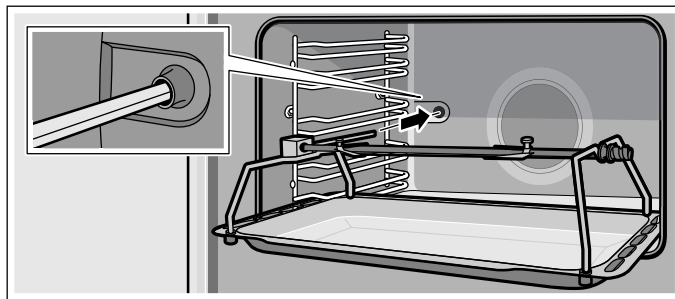

3. 将普通烤盘滑入第 1 烹饪层，然后将旋转烤叉滑入电机座。



4. 关闭电器门。

开启旋转烤叉

提示: 使用烤叉时，使用  加热功能加热烤箱。在设置  加热功能之前，插入烤叉。

1. 将功能选择钮旋转至  位置。
2. 设置烧烤设置。

提示: 向普通烤盘中倒入一些水，接住低落的油脂。

拆下旋转烤叉

⚠ 警告 – 有灼伤危险!

切勿触摸烹饪箱的灼热表面或加热元件。务必将小孩留在电器安全距离以外。打开电器门时要小心。可能会有热蒸汽逸出。

1. 打开电器门
2. 缓慢抽出普通烤盘，直到其中一半伸出烹饪箱。
3. 将普通烤盘完全从烹饪箱中取出，放在工作台上。
4. 拧上手柄，从烤叉架上拆下烤叉。

自动安全关断功能

本产品设有自动安全切断功能。电器在 13 小时后自动关断。

时间设置选项

您的电器具有不同的时间设置选项。



时间设置选项一览

时间设置选项	用途
 定时器	定时器功能与煮蛋定时器类似。使用其他时间设置选项加热时，它独立于电器运行，不影响电器。
 时钟	当前台不再运行其它功能时，电器将在显示屏上显示时间。
 烹饪时长	设置的烹饪时间到后，电器会自动停止加热。
 结束时间	输入烹饪时间和所需的结束时间。电器将自动启动，并在所需的时间完成烹饪。

操作电子钟

设置定时器

定时器对烤箱工作无影响。定时器持续时间设置范围为 30 秒至 13 小时。持续时间可以按 30 秒的增量进行设置，最长达 10 分钟；在 10 分钟和 1 小时之间按 1 分钟的增量进行设置；然后按 5 分钟的增量进行设置。

1. 按下  按键。
 符号将点亮。
2. 使用 **+** 和 **-** 按键设置所需要的烹饪时间。
时间到后就会发出一个信号音。

提示

- 如要更改剩余时间，按下  按键。然后使用 **+** 和 **-** 按键更改剩余时间。
- 如要停止定时器倒计时，可将剩余时间设置为零。





关断信号音

要关闭信号，请按下任意按键或打开电器门。

提示: 在很短时间后，信号音将自动停止。

设置电子时钟

您可在需要时更改时钟，例如，从夏令时更改到冬令时。为此必须关闭烤箱。



1. 按下  按键。
 符号将点亮。
2. 再次按下  按键。
 符号将点亮。
3. 使用 **+** 和 **-** 按键设置当前时间。

设置自动定时器

电子钟可用于自动开启或关断烤箱。

设置烹饪时间

可以在电器上设置食物的烹饪时间。这可防止食物被意外地过长时间烹饪，同时意味着您不必为了关断烤箱而停下手头的工作。

1. 设置需要的加热类型和温度。
烤箱将启动。
2. 按下  按键两次。
3. 使用 **+** 和 **-** 按键设置所需要的烹饪时间。
提示: 烹饪时间设置范围为 30 秒至 13 小时。烹饪时间可以按 1 分钟的增量进行设置，达到 1 小时后按 5 分钟的增量进行设置。
 符号将点亮。





烹饪时间到时

信号音响起。电器停止加热。

1. 要关闭信号，请按下任意按键或打开电器门。
提示: 在很短时间后，信号音将自动停止。
2. 将功能选择钮转到“关”位置。

设置结束时间

稍后在您设置的时间烘焙或烤制。

1. 设置需要的加热类型和温度。
烤箱将启动。
2. 按下  按键两次。
3. 使用 **+** 和 **-** 按键设置所需要的烹饪时间。
提示: 烹饪时间设置范围为 30 秒至 13 小时。烹饪时间可以按 1 分钟的增量进行设置，达到 1 小时后按 5 分钟的增量进行设置。
 符号将点亮。
4. 再次按下  按键。
5. 使用 **+** 和 **-** 按键设置结束时间。
提示: 当首次按下按键时，显示屏上将提示一个数值。该建议值通过时钟上的当前时间和烹饪时间计算得出。该值可使用 **+** 和 **-** 按键进行更改。
 符号将点亮。显示屏将显示结束时间。电器此时将切换至待机模式。

烹饪时间到时

信号音响起。电器停止加热。

1. 要关闭信号，请按下任意按键或打开电器门。
提示: 在很短时间后，信号音将自动停止。
2. 将功能选择钮转到“关”位置。

儿童锁

烤箱有一个儿童锁，可防止儿童意外打开烤箱。

提示: 如果连接了灶具，灶具不会受烤箱上的儿童锁的影响。

激活儿童锁

必须关断电器。

按下并按住  按键大约 4 秒钟。

 符号将出现在显示屏上。儿童锁现已启用。

取消激活儿童锁

按下并按住  按键大约 4 秒钟。

 符号将在显示屏上熄灭。儿童锁现已停用。

基本设置

为了帮助您有效地使用电器，我们为您提供了各种设置。您可以根据需要更改这些设置。

基本设置列表



根据电器的功能，并非所有基本设置都可供访问。

基本设置	选项
c01	烹饪时间或定时器时间到时的信号音持续时间 1 = 约 10 秒钟 2 = 约 30 秒钟* 3 = 约 2 分钟
c02	应用某个设置之前需要等待的时间 1 = 约 3 秒钟 2 = 约 6 秒钟 3 = 约 10 秒钟
c03	触碰按键时会有声音响起 0 = 关 1 = 开*
c04	显示亮度 1 = 暗 2 = 中 3 = 亮
c05	显示时间 0 = 隐藏时间 1 = 显示时间*
c06	当电器工作时，内部照明打开 0 = 否 1 = 是*
c07	冷却风扇持续运行时间 1 = 短* 2 = 中 3 = 长 4 = 超长
c08	将所有值重置为出厂设置 0 = 否* 1 = 是
c09	激活演示模式 演示模式仅用于演示目的；烤箱在演示模式下不会加热。演示模式仅在电器连接到电源后的前 5 分钟内可以启用。 0 = 否* 1 = 是

* 工厂设置

更改基本设置

必须将功能选择钮转到“关”位置。

- 按下并按住  按键大约 4 秒钟。
第一个基本设置将显示在显示屏中，如 c011。
- 转动温度选择钮，根据需要更改设置。
- 使用 **+** 按键浏览下一个基本设置。
- 使用 **-** 或 **+** 按键继续按照上述说明完成所有基本设置，必要时使用温度选择钮更改设置。
- 结束后，再次按下并按住  按键约 4 秒，确认设置。这会应用所有基本设置。

您可以随时再次更改基本设置。演示模式仅在电器连接到电源后的前 5 分钟内可以启用。

提示: 即使断电，所更改的基本设置仍然保留。

设置节能模式

通过降低屏幕亮度可以节能。显示屏亮度可在基本设置中进行设置 **c04**。

提示: 在电器运行时, 该设置可以改变显示屏亮度。在待机模式下, 电器自动降低显示屏亮度。显示屏在晚上 22:00 和 05:59 之间亮度最低。

清洁

只要精心保养和清洁, 您的电器将在未来的很长一段时间内保持其外观, 并能正常工作。以下说明应如何正确保养和清洁电器。

⚠ 警告 – 有电击危险!

请勿使用高压清洁剂或蒸汽清洁剂, 以防触电。

⚠ 警告 – 有灼伤危险! !

电器会变灼热。切勿触摸烹饪箱的内表面或加热元件。必须让电器冷却下来。请将小孩留在安全距离以外。

合适的清洁剂

请遵守下表中的信息, 以避免因清洗用品使用不当而损坏不同材质的表面。

请勿使用任何以下物品:

烤箱上:

- 强烈的或腐蚀性的清洁剂,
- 高酒精浓度的清洁剂
- 硬的清洗垫或海绵,
- 高压清洁剂或蒸汽清洁剂。

新海绵布使用前要彻底清洗。

区域	清洁
电器外部	
不锈钢前面板	热肥皂水: 用洗碗布清洁, 然后用软布擦干。 立即清除水垢、油脂、淀粉和蛋白(例如蛋清)形成的斑点。这类污渍可能会形成斑点。 适用于灼热表面的专用不锈钢清洁用品可从我们的售后服务部或从专卖店购买。使用软布涂抹一层清洁产品。
控制面板	热肥皂水: 用洗碗布清洁, 然后用软布擦干。 不要使用玻璃清洁剂或玻璃刮刀。
门面板	热肥皂水: 用洗碗布清洁, 然后用软布擦干。 不要使用玻璃刮刀或不锈钢擦洗片。
门把手	热肥皂水: 用洗碗布清洁, 然后用软布擦干。 如果除垢工具接触到门把手, 请立即擦掉。否则, 将产生无法去除的污斑。

电器内部

上釉区域	热 皂液或醋水: 用洗涤布清洁, 然后用软布擦干。 用湿布和皂液软化 烤糊的食物残渣。严重脏污时, 使用不锈钢球刷 或烤箱清洁剂。 注意! 切勿在热的烹饪室内使用烤箱清洁剂。可能会损坏 上釉区域。下一次加热前, 将残渣 从烹饪室内和设备门上完全清除。 清洁后, 让烹饪室敞开, 以便干燥。 最好使用清洁功能。→ "清洁功能"第 39 页 提示: 食物残渣可能形成 白色覆盖物。这种覆盖物可以忽略不计, 不会影响设备功能。 必要时, 用柠檬酸清除。
内部照明玻璃灯罩	热肥皂水: 用洗碗布清洁, 然后用软布擦干。 如果烹饪箱严重脏污, 请使用烤箱清洁剂。
门面板	热肥皂水: 用洗碗布清洁并用软布擦干。 不要使用玻璃刮刀或不锈钢擦洗片。 最好清洁门面板以及烹饪箱的其余部分。→ "清洁烹饪箱"第 39 页
门密封 不要拆下。	热肥皂水: 用洗碗布清洁。 不要擦洗。
门盖	不锈钢材质。 使用不锈钢清洁剂。遵守制造商说明。不要使用不锈钢护理产品。 塑料制成 用热肥皂水和洗碗布清洁。用软布擦干。不要使用玻璃清洁剂或玻璃刮刀。 拆下门面板进行清洗。
导轨	热肥皂水: 浸泡并用洗碗布或刷子清洁。
弹出系统	热肥皂水: 用洗碗布或刷子清洁。 抽出拉出式导轨时, 请不要擦去润滑剂, 最好在拉出式导轨处于推入位置时进行清洗。不要在洗碗机中清洁。
附件	热肥皂水: 浸泡并用洗碗布或刷子清洁。 如果有大量污垢积聚, 则使用不锈钢擦洗片。

提示

- 由于使用不同的材料, 例如, 玻璃、塑料和金属等, 电器正面的颜色会稍微有点偏差。
- 门面板上看起来像条纹的阴影是由内部照明的反光造成的。
- 搪瓷是用非常高的温度烤上去的。这可能会导致一些轻微的颜色变化。这是正常现象, 不影响工作。较薄的烤盘边缘可能有些地方没有涂上搪瓷。因此, 这些边缘可能会比较粗糙。这不会损害抗腐蚀保护功能。

保持电器清洁

始终保持电器清洁并立即清除污垢，以防形成顽固积垢。

警告 – 火灾危险!

散落的食物残渣、油脂和烤肉汁可能自燃。投入运行前，去除烹饪室内、加热元件和附件上的脏污。

建议

- 每次使用后清洁烹饪箱。这将确保不会烘烤污垢。
- 一定要立即清除水垢、油脂、淀粉和蛋白(例如蛋清)形成的斑点。
- 使用普通烤盘烤制非常潮湿的蛋糕。
- 使用适用的烤箱器皿进行烘烤，例如烤肉盘。

清洁烹饪箱

1. 将 0.4 升水倒入烹饪箱底板的中央。
2. 设置  加热功能。
3. 使用温度控制器将温度设置为 50 °C。
4. 在 18 分钟后关断电器。
5. 让电器冷却下来。
6. 用布清洁烹饪箱。

警告 – 有灼伤危险! !

电器会变灼热。切勿触摸烹饪箱的内表面或加热元件。必须让电器冷却下来。请将小孩留在安全距离以外。

清洁功能

电器具有自清洁功能。您可使用自清洁功能清洁烹饪箱。

高温分解模式

您可使用“高温分解模式”模式毫不费力地清洁烹饪箱。将烹饪箱加热到非常高的温度。由于烧烤和烘焙产生的残余物将燃烧。

运行该程序需要约 5-10 千瓦时，具体取决于时间设置。清洁程序运行时间的设置范围为 2 小时 30 分钟至 3 小时 30 分钟。

提示: 出于安全原因，烹饪箱箱门自动锁闭。在锁指示器  熄灭之前，它无法再打开。电器清洁时，内部照明始终关闭。

警告 – 有严重损害健康的危险!

在清洁循环期间，电器将变得灼热。烤盘和烤模上的不粘涂层被损坏，会释放出有毒气体。切勿使用清洁功能来清洁不粘烤盘或烤模。只可使用清洁功能清洁搪瓷附件。

警告 – 有灼伤危险!

- 在清洁循环期间，烹饪箱将变得灼热。请勿打开电器门。让电器冷却下来。让儿童远离本电器。
-  在清洁循环期间，电器外壁将变得灼热。切勿触摸电器门。让电器冷却下来。让儿童远离本电器。
- 电器会变灼热。切勿触摸烹饪箱的内表面或加热元件。必须让电器冷却下来。请将小孩留在安全距离以外。

在执行清洁功能之前

注意!

进行清洁时，烤架支架和抽拉式导轨如果留在烤箱中将会受损。在启动清洁功能之前，从烹饪箱中拆下烤架支架和抽拉式导轨。

1. 从烹饪箱中取出烤架支架和抽拉式导轨。
2. 去除烹饪箱中的严重食物残留物。
3. 清洁电器门内部和烹饪箱边缘的密封区域。不要擦洗密封零件。

警告 – 有着火危险!



- 在清洁过程中，松散的食物残留物、脂肪和肉汁可能会着火。在启动清洁功能之前，必须去除烹饪箱上的严重食物残余物。
- 在清洁循环期间，电器外壁将变得灼热。切勿在门把手上悬挂易燃物品，例如毛巾。切勿紧靠电器正面放置任何物品。让儿童远离本电器。

启动

1. 将功能选择钮转动到  加热功能。
2. 使用温度选择钮设置清洁设置。

清洁设置:	持续时间
1	2 小时 30 分钟
2	3 小时
3	3 小时 30 分钟

提示: 在清洁循环过程中移动功能选择钮将停止高温分解自清洁程序。

在清洁循环 (高温分解自清洁) 开始 1 分钟后, 烤箱门锁定, 防止其打开。指示灯  亮起, 指示门锁已开启。门锁开启后无法再选择任何功能。如要选择功能, 等待  指示灯熄灭。

提示: 在高温分解自清洁程序运行时, 可以继续使用定时器。所设置的持续时间对高温分解自清洁功能无影响。

提示: 在高温分解自清洁程序运行时, 将无法使用内部照明。

取消

如要取消程序, 将功能选择钮转到“关断”位置。

结束

自清洁功能运行结束后, 就会发出一个信号音。在  符号熄灭之前, 电器门无法打开。

清洁功能结束后

烹饪箱冷却下来之后, 用湿布擦去留在烹饪箱、烤架和电器门周围的灰烬。

提示: 顽强污垢可能造成白色沉淀污渍留在瓷釉表面上。这是无损害的食物残渣。不会影响其功能。如果有需要, 您可以使用柠檬汁来清除这些残留物。

导轨

拆卸烤架支架

烤架支架固定在烹饪箱侧壁的三个点上。

1. 握住烤架支架前方, 抽出至烹饪箱中间。
烤架支架的前钩将从孔中脱出。
2. 将烤箱支架摇开, 将其从侧壁后方的孔中抽出。
3. 从烹饪箱中取出附件和支架。

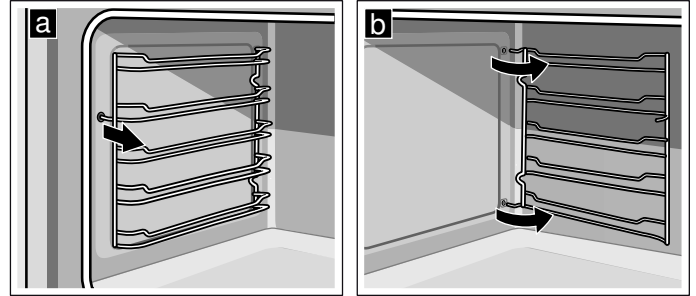

重新安装烤架支架

1. 将烤架支架的钩子插入侧壁后方的孔 中。
2. 将烤架支架的前钩推入孔 中。

电器门

只要精心保养和清洁，您的电器将在未来的很长一段时间内保持其外观，并能正常工作。这里说明如何清洁电器门。

拆除和安装门面板

为了便于清洁，您可从烤箱门卸下玻璃面板。

拆除门面板

1. 完全打开烤箱门。
2. 使用锁针将左右两侧的铰链锁上。
提示：锁针必须完全插入铰链孔。

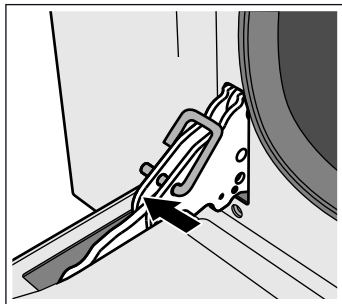

3. 用双手抬起内门板底部，直到固定销从支架中脱出。
4. 小心地将内壁顶部抽出固定条，将其抬起，使面板彻底离开门。

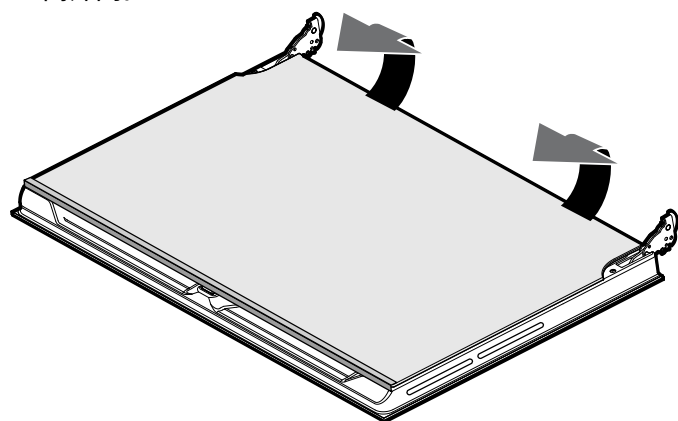

5. 取下两个中间面板及其托架。
提示：两个中间面板未用固定销固定；而是使用托架固定。

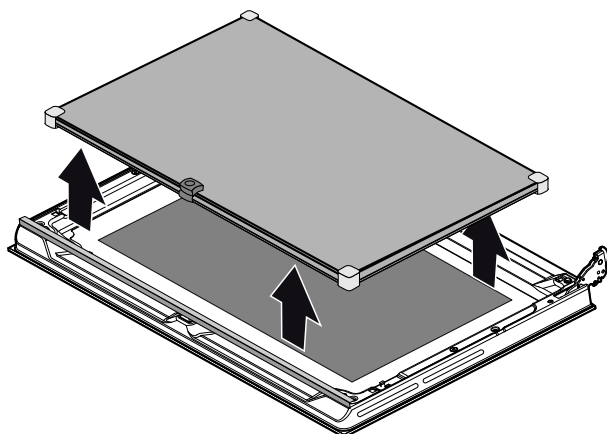

6. 取下托架，使两个中间面板分开。
7. 用玻璃清洁剂和软布清洁面板。

警告 – 有受伤危险!

电器门玻璃如果有刮伤，可能会导致裂开。请不要使用玻璃刮刀、剧烈或腐蚀性的清洁用品或洗涤剂。

安装门面板

1. 重新插入两个中间面板。

提示

- 如果两个显示面板上显示“低辐射”符号，表示两个中间面板已正确插入。
- 请确保将面板安装至正确的位置。所有支架必须平放在外门板上。

2. 重新插入内门板。

提示：必须首先将面板插入固定杆。然后必须将两个固定销卡入配套的支架中。

3. 拆除锁针并关上烤箱门。

拆卸和安装电器门

如果烤箱非常重，可拆卸烤箱门以便清洁。正常来说，此非必要步骤。

拆卸电器门

1. 完全打开烤箱门。
2. 使用锁针 (a) 将左右两侧的铰链锁上。
提示：锁针必须完全插入铰链孔。
3. 双手握住烤箱门的两侧，关闭烤箱门约 30° (b)。

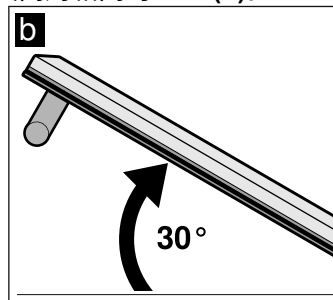
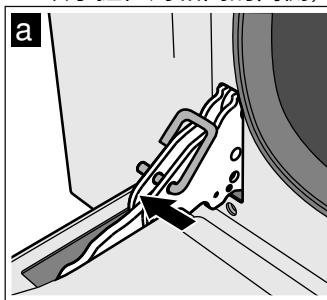

4. 稍微抬起烤箱门，将其拉出。
提示：不要完全关闭烤箱门，否则铰链将弯折，珐琅会损坏。

安装电器门

1. 双手握住烤箱门的两侧。
2. 将铰链滑入烤箱中的开槽 (a)。
提示：铰链底部的开槽必须卡入烤箱框架 (b)。

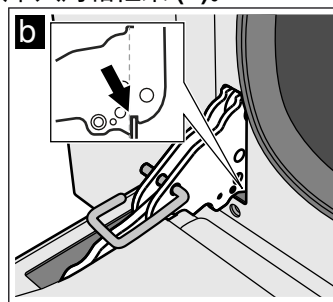
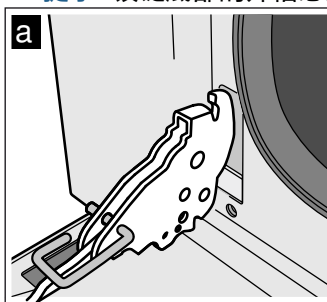

3. 降低门。
4. 拆除锁针。

警告 – 有受伤危险!

如果烤箱门意外掉下或铰链猛然闭合，不要将手伸入铰链。致电售后服务部门。

警告 – 有受伤危险!

如果门铰链未正确定位，门可能无法正确关闭。这将造成热气溢出，电器各个部件可能会变得十分滚烫。为了防止这种情况，请再次拆下电器门。然后如图所示安装电器门，确保铰链下方的开槽卡入烤箱架。

故障检修

故障	可能的原因	说明/补救措施
电器不工作	插头没有插入电源	将电器连接到电源
	断电	检查其他厨房电器是否工作
	断路器故障	检查保险丝盒，确保电器保险丝正常
电器不能启动	电器门没有完全关闭	关闭电器门
	未关断电器	关断电器，然后再重新接通
12:00 在显示屏中闪烁	电源故障	复位时钟。
内部照明不工作	激活顶部/底部温和加热模式	在顶部/底部温和加热模式下，内部照明不打开。
	灯泡出现故障	更换灯泡。
在烤箱中烹饪的所有食物均在极短时间内烧焦。	自动调温器故障。	致电售后服务部门。
门面板有水气。	这是正常现象，是由于温差引起的。	加热电器至 100 °C，在 5 分钟后重新关断。
虽然电器已打开，但却无法操作； ∞ 符号出现在显示屏中	儿童锁启用。	按下并按住 ∞ 按键，直到 ∞ 符号消失。
电器门将不打开； 🔒 符号出现在显示屏中	电器门被锁定，直至烹饪箱冷却下来。	等待直至 🔒 符号熄灭

故障消息

如果显示屏上显示以 *Err* 开头的出错消息，请将功能选择按钮设置为“关”。如果出错信息不消失，请联系售后服务部。

出错信息	可能的原因	信息 / 纠正措施
<i>Err 1</i>	温度感应器故障。	致电售后服务部门。
<i>Err 2</i>	烹饪箱中的温度过高。	致电售后服务部门。
<i>Err 4</i>	错误启用门锁机构。	致电售后服务部门。
<i>Err 5</i>	风扇加热元件发生故障或未连接。	致电售后服务部门。
<i>Err 6</i>	电动机发生故障或未连接。	致电售后服务部门。
<i>Err 8</i>	冷却风扇发生故障或未连接。	致电售后服务部门。

更换烤箱灯泡

如果烤箱灯的灯泡坏了，则必须进行更换。耐热备用灯泡可从售后服务部或专卖店购买。请指定您的电器的 E 编号和 FD 编号。请勿使用其他类型的灯泡。

⚠ 警告 – 有电击危险!

更换烹饪箱灯泡时，灯泡插座触点是带电的。更换灯泡前，拔下电器电源插头或断开熔断器盒中的断路器。

1. 让烹饪箱冷却下来。
2. 打开电器门。
3. 将抹布放在冷烹饪箱中，防止损坏。
4. 取出烤架支架。
5. 拆下玻璃盖板。为此可从前面用手将玻璃盖板打开。如在拆下玻璃面板时感到困难，可借助勺子完成。

6. 拆下烤箱灯泡。

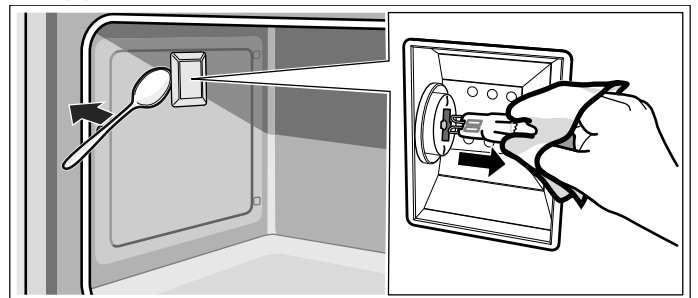

7. 用相同类型的灯泡更换烤箱灯泡：

电压：230 V；
功率：40 W；
安装：G9；
耐热：300 °C

8. 重新安装烤箱灯的玻璃罩。
9. 重新安装烤架支架。
10. 取出茶巾。
11. 将断路器重新拧好。
12. 检查烤箱照明是否正常。

主要技术参数

额定电压范围：220-240 V~，额定频率：50 Hz

额定功率：3300 W

客户服务

如果您的电器需要修理，我们为您提供售后服务。我们会找出合适的解决方法，并尽量避免售后人员不必要的上门服务。

E 编号和 FD 编号

联系我们时请您说明完整的产品编号 (E 编号) 和生产编号 (FD 编号)，以便我们为您提供高水平的服务。当您打开设备门后，就能看见带编号的型号铭牌。在某些带蒸制功能的设备上，型号铭牌位于面板后。

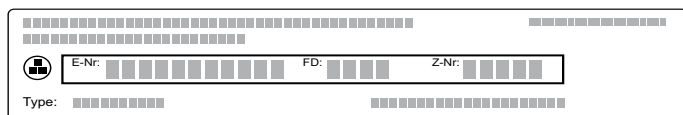

为了避免您在需要时长时间寻找，请在这里记录设备数据和客户服务部门电话号码。

E 编号	FD 编号
客户服务部门 	

请注意，即使在保修期内，发生误操作后 客户服务人员的现场服务也不是免费的。

请在随设备提供的客户服务列表中查找所有国家的联系信息。

预约工程师上门及产品咨询

中文 400 885 5888

电话费率取决于所用网络。

制造商的专业水平值得您信赖。因此，将由受过专业训练的技术服务人员使用原装电器零件为您维修。

经销商及原产地信息

原产地：意大利

总经销商：博西家用电器（中国）有限公司，地址：南京市中山路129号中南国际大厦20、21楼

执行标准：

GB 4706.1-2005 家用和类似用途电器的安全 第1部分：通用要求

GB 4706.22-2008 家用和类似用途电器的安全 驻立式电灶、灶台、烤箱及类似用途器具的特殊要求

经由我们烹饪工作室测试过的菜谱

这里提供了各种备选食谱及其理想设置。我们将向您展示，哪种加热类型和哪种温度最适合您的菜肴。您将了解关于合适的烹饪附件及其在电器中放置高度的信息。您还将了解关于烹饪容器和制备方法的一些提示。



提示: 在烹饪食物时，烹饪箱内会蓄积大量的蒸汽。在工作期间，您的电器非常节能，同时向其周围环境辐射的热量也很小。由于电器内部和电器外部部件之间的温差较大，因此电器门、控制面板或相邻的橱柜面板上可能会蓄积冷凝液。这是一种正常的物理现象。可通过预热微波炉或小心地打开电器门减少冷凝液。

菜谱

餐点	重量 (kg)	烹饪层	加热功能	温度 (°C)	烹饪时间 (分钟)
意式烤宽面	3-4	1		220-230*	45-50
烤通心粉	3-4	1		220-230*	45-50
小牛肉块	2	2		180-190*	90-100
猪腰肉	1.5-2	2		190-200*	90-100
猪腰肉	2	2		200**	125
香肠	1.5	3		280*	第一面: 10 第二面: 7
焖烧牛肉	1	2		200*	45-55
烤兔肉	1.5	2		180-190*	70-80
火鸡胸肉	2	2		180-190*	110-120
猪脖肉	2-3	2		180-190*	170-180
烤子鸡	1.2	2		190-200*	65-70
排骨	1.5	3		280*	第一面: 15 第二面: 5
肋排	1.5	3		280*	第一面: 15 第二面: 10
培根	0.7	4		3*	第一面: 10 第二面: 8
猪肉片	1.5	3		280*	第一面: 12 第二面: 5
牛肉片	1	4		3*	第一面: 7 第二面: 4
大型虹鳟鱼	0.7-1.2	2		160-170*	35-40
安康鱼	0.7-1.5	2		160*	60-65
大比目鱼	1.5	2		160*	45-50
匹萨	1-1.5	2		280*	10-12
面包	1	2		180-190*	25-30
佛卡夏面包	1	2		180-190*	20-25
邦特环形蛋糕	1	2		160*	55-60
水果馅饼	1	2		160*	35-40
奶酪蛋糕	1	2		160-170*	45-55
油酥面团	1	2		160-170*	35-40
油酥面团	1	2		170**	65
冻糕	1.2	2		160*	55-60
奶油泡芙	0.7-1.2	2		180*	50-60
海绵蛋糕	1	2		150-160*	55-60

* 预热

** 无需预热

餐点	重量 (kg)	烹饪层	加热功能	温度 (°C)	烹饪时间 (分钟)
米饭布丁	1	2		160*	55-60
奶油蛋卷	1-1.2	2		160*	30-35
* 预热					
** 无需预热					

电器使用提示

有一些关于烹饪容器和制备方法的提示。

提示

- 使用所提供的附件。额外附件可以在售后服务部、专卖店的专用附件中选购。
在使用烤箱之前，先从烹饪箱中取出不必要的附件和烹饪容器。
- 在从烹饪箱中取出附件或炊具时，一定要使用烤箱布或烤箱手套。

烘焙技巧

您想确定蛋糕的中间部分是否已完全烤熟。	将取食签推入蛋糕的最高点。如果拿出后的取食签是干净的且没有面团残留物，说明蛋糕已经烤熟。
蛋糕坍塌。	下次使用更少的液体。另外，将温度设低 10 °C，并烹饪更长的时间。请遵循菜谱中指定的配料和制备说明。
蛋糕中间已经膨起，但边缘坍塌。	仅在弹性蛋糕模底部涂油脂。烘焙后，用小刀小心地松开蛋糕。
果汁溢出。	下次请使用普通烤盘。
小烘焙食品在烘焙时会粘连在一起。	每件食品应相隔 2 厘米左右。这让烘焙食品有足够的空间充分膨胀，每一面都能着色。
蛋糕太干。	将设置温度调高 10 °C，并缩短烘焙时间。
蛋糕整体颜色太浅。	如果烹饪层和烹饪容器正确，则应根据需要增加温度或延长烘焙时间。
蛋糕顶部颜色太浅，底部颜色太深。	下次在烤箱中的较高一层烘焙蛋糕。
蛋糕顶部颜色太深，底部颜色太浅。	下次在烤箱中的较低一层烘焙蛋糕。选择较低的温度，并延长烘焙时间。
在烤盘或烤模中烘焙的蛋糕后部颜色太深。	将烤盘放在附件中间，不要紧贴后壁。
整个蛋糕颜色太深。	下次选择较低的温度，并根据需要延长烘焙时间。
蛋糕呈不均匀的褐色。	选择略低的温度。 防油纸伸出会影响空气流通。一定要将防油纸剪裁到合适尺寸。 确保烤模没有正对烹饪箱后壁中的开口。 当烘焙小食品时，应尽可能使用类似的尺寸和厚度。
如果您正在同时使用好几层进行烘焙。顶层烤盘中的食品会比底层烤盘中的食品颜色深一些。	一定要在同时使用好几层进行烘焙时选择热风。同时放进烤箱烤盘或烤模/餐具的烘焙食品不一定会同时烤好。
蛋糕看起来很好，但中间部位没有烤熟。	请使用较低的温度，并稍微烤久一点；根据需要稍微少放点液体。对于有湿配料的蛋糕，首先烘焙底部。然后洒上杏仁或面包屑，并把配料点缀在顶部。
将蛋糕翻转后，不能将其翻出蛋糕模。	烘焙之后，让蛋糕冷却 5 到 10 分钟。如果仍然粘连，可用刀子小心切开蛋糕边缘。再次翻转蛋糕模，并用冷的湿布将其覆盖几次。下次在烤模/餐具上涂上油脂，再撒面包屑。

烤制和精烹提示

烤肉颜色太深，脆皮烧焦和/或烤肉太干。	检查烹饪层和温度。下次选择较低的温度，并根据需要缩短烤制时间。
脆皮太薄。	提高温度，或在烤制时间结束时短时打开烧烤。
烤肉看上去很好，但肉汁烧干了。	下次用一个小一些的烤肉盘，并根据需要多加汁液。
烤肉看上去很好，但肉汁太清，水淋漓的。	下次用大一些的烤肉盘，并根据需要少加汁液。
肉在炖煮时烧焦。	烤肉盘和盖子必须尺寸合适，闭合严密。 炖煮时根据需要降低温度并添加更多汁液。

食品中的丙烯酰胺

丙烯酰胺主要产生于以高温制备的谷类和土豆产品中，例如土豆条、土豆片、切片面包、面包卷、面包、精烘焙食物(饼干、姜饼、五香饼干)。

使丙烯酰胺降至最少的技巧	
概述	<ul style="list-style-type: none">■ 保持烹饪时间尽量短。■ 烹饪时食物颜色变为金黄褐色即可，颜色不要太深。■ 又大又厚的食品包含的丙烯酰胺较少。
烘焙	顶部 / 底部加热，最高 200 °C。 热风，最高 180 °C。
饼干	顶部 / 底部加热，最高 190 °C。 热风，最高 170 °C。 蛋或蛋黄可减少丙烯酰胺的产生。
烤薯片	在烤盘上均匀地铺开一层。每个烤盘上至少烤 400 g，这样不会烤干。

产品保修指南

友情提示

- 如果您的机器出现异常现象，在联系客服之前，请先阅读机器说明书中的《故障检修》进行排除。
- 如果维修人员上门后发现机器并无故障，即使在包修期内，您也将承担相关费用。
- 您可以在本指南中找到客户服务的联系方式。
在上门服务前请提供下列信息：
详细地址和电话号码、故障描述、购机及收货日期、产品型号（E-Nr）、生产日期（FD）。
上述信息有助于更好地为您提供服务，同时也可以为您省去不必要的开支。产品型号请参见铭牌。

友情提示

1. 根据《中华人民共和国消费者权益保护法》和《部分商品修理更换退货责任规定》，本机作为家用电器，自购买收货之日起整机包修1年，主要部件包修1年。用于生产经营目的、商用、公司集体使用等用途所购买的家电，其整机及主要零配件自收货之日起包修期为3个月，除非购销合同中另有规定。
法律法规另有规定的，按照其规定执行。
2. 产品存在瑕疵但不影响产品的性能、功能，也不违反国家强制性规定，长方、商业单位作降价处理的，其包修条件同上，但因此而降价的部件不予包修。
3. 包修期内，用户修理时必须提供修理产品的有效收货凭证、购买发票和厂方指定的相关三包凭证，三包包修期自购买收货之日算起。如果收货凭证遗失，按照购买发票日期顺延7日作为三包开始日期。如果收货凭证和购买发票同时遗失且不能提供有限信息，按照出厂日期顺延45日作为包修开始日期。
4. 除另有规定外，下列项目不属于免费包修范围，应实行收费修理。
 - 用户搬运，安装，使用，维护，保管不当而损坏的；
 - 使用电源电压低于187伏或高于240伏而损坏的；
 - 自行或非厂方特约维修点拆修的；
 - 无有效购买发票和三包凭证的；
 - 购买发票或三包凭证型号与产品型号不符或涂改的；
 - 因不可抗据力造成产品损坏的；
 - 过了免费包修期的。
5. 由于产品使用环境条件，例如：电源、水源、温度、湿度等非本公司所控制的因素引起的一切损坏及损失，不在包修范围内。

服务保障措施

- 24小时热线
- 原厂配件
- 全程服务
- 延保计划

联系方式

全国统一客户服务热线：4008855888
 客户服务传真：025-84701672
 客户服务电子邮箱：careline.china@bshg.com
 公司网址：www.bosch-home.cn

博世家用电器客户服务保修卡

BOSCH	顾客姓名		联系电话	
	联系地址			
	购买日期			
	产品型号		发票号码	
	维修点名称		维修点电话	

结算第五联

BOSCH		顾客姓名		联系电话	
		购买日期		发票号码	
		产品型号		出厂年月	
		维修日期		出厂序号	

结算第四联

BOSCH		顾客姓名		联系电话	
		购买日期		发票号码	
		产品型号		出厂年月	
		维修日期		出厂序号	

结算第三联

BOSCH		顾客姓名		联系电话	
		购买日期		发票号码	
		产品型号		出厂年月	
		维修日期		出厂序号	

结算第二联

BOSCH		顾客姓名		联系电话	
		购买日期		发票号码	
		产品型号		出厂年月	
		维修日期		出厂序号	

结算第一联

BOSCH		顾客姓名		联系电话	
		购买日期		发票号码	
		产品型号		出厂年月	
		维修日期		出厂序号	

食品接触用材料及制品信息

本产品中下列预期或可能与食品接触用材料及制品，符合 GB 4806.1-2016 及相应食品接触材料及制品的食品安全国家标准要求。

食品接触用材料		用途	执行标准	备注
钢 1.0394 (Mn:0.40,P:0.03,S:0.05) /搪瓷		内腔, 烤盘等	GB 4806.3-2016 GB 4806.9-2016	不得长时接触酸性食品
陶瓷/搪瓷		披萨盘	GB 4806.3-2016 GB 4806.4-2016	
金属	钢 FE360 基材 (C:0.17,P:0.045,S:0.045, N2:0.09) (镀铬)	烤架, 烤肉架等	GB 4806.9-2016	不得接触酸性食品
	不锈钢 10Cr17	烤肉叉等		

注 1: 上表包含了本公司生产的此类产品的预期或可能与食品接触的全部部件, 本产品的部件以实际配置为准。

注 2: 请根据说明书要求正常使用本产品, 限制使用条件见上表备注栏。

未按上述要求使用本产品所造成的食品污染以及相应的人身损害由使用人自行承担相应法律责任。

如您对此有任何疑问, 请拨打本产品所提供的公司客服电话。

产品中有害物质的名称及含量

部件名称	有害物质					
	铅 (Pb)	汞 (Hg)	镉 (Cd)	六价铬 (Cr(VI))	多溴联苯 (PBB)	多溴二苯醚 (PBDE)
印制电路组件	×	○	○	○	○	○
显示单元	○	○	○	○	○	○
电源线及连接线	○	○	○	○	○	○
电机、驱动部件及风扇	○	○	○	○	○	○
外壳组件	○	○	○	○	○	○
隔热组件	○	○	○	○	○	○
加热腔体组件	○	○	○	○	○	○
照明组件	○	○	○	○	○	○
门体组件	○	○	○	○	○	○

本表格依据SJ/T 11364 的规定编制。

○：表示该有害物质在该部件所有均质材料中的含量均在 GB/T 26572 规定的限量要求以下。

×：表示该有害物质至少在该部件的某一均质材料中的含量超出GB/T 26572 规定的限量要求。

注意：上表包含了本公司生产的此类产品的全部部件，本产品的部件以实际配置为准。如您对此有任何疑问，请拨打本产品所提供的公司客服电话。

产品环保信息提示性说明

请按照产品说明书的要求使用和维护本产品，不当利用或者处置本产品可能会对环境和人类健康造成影响。

依照国家《废弃电器电子产品回收处理条例》的有关规定，当您计划将此产品废弃时，请将其交给具有废弃电器电子产品处理资格的处理企业进行处理。产品中有毒有害物质含量信息参照上表。



Thank you for buying a Bosch Home Appliance!

Register your new device on MyBosch now and profit directly from:

- **Expert tips & tricks for your appliance**
- **Warranty extension options**
- **Discounts for accessories & spare-parts**
- **Digital manual and all appliance data at hand**
- **Easy access to Bosch Home Appliances Service**

Free and easy registration – also on mobile phones:
www.bosch-home.com/welcome



Looking for help? You'll find it here.

Expert advice for your Bosch home appliances, need help with problems or a repair from Bosch experts.

Find out everything about the many ways Bosch can support you:

www.bosch-home.com/service

Contact data of all countries are listed in the attached service directory.

Robert Bosch Hausgeräte GmbH
Carl-Wery-Straße 34
81739 München
Germany
www.bosch-home.com



博世家电官方微信公众号



9001299218
990208