

# USER MANUAL



# IMPORTANT INFORMATION THAT MAY IMPACT YOUR MANUFACTURER'S WARRANTY

Adherence to the directions for use in this manual is extremely important for health and safety. Failure to strictly adhere to the requirements in this manual may result in personal injury, property damage and affect your ability to make a claim under the AEG manufacturer's warranty provided with your product. Products must be used, installed and operated in accordance with this manual. You may not be able to claim on the AEG manufacturer's warranty in the event that your product fault is due to failure to adhere to this manual.

## FOR PERFECT RESULTS

Thank you for choosing this AEG product. We have created it to give you impeccable performance for many years, with innovative technologies that help make life simpler features you might not find on ordinary appliances. Please spend a few minutes reading to get the very best from it.

Visit our website for:



Get usage advice, brochures, trouble shooter, service information:  
**[www.aeg.com](http://www.aeg.com)**



Register your product for better service:  
**[www.registeraeg.com](http://www.registeraeg.com)**

## CUSTOMER CARE AND SERVICE

Always use original spare parts.

When contacting our Authorised Service Centre, ensure that you have the following data available: Model, PNC, Serial Number.

The information can be found on the rating plate.

 Warning / Caution-Safety information

 General information and tips

 Environmental information

Subject to change without notice.

# CONTENTS

---

<b>1. SAFETY INFORMATION.....</b>	<b>5</b>
1.1 Children and vulnerable people safety.....	5
1.2 General Safety.....	5
<b>2. CONDITIONS OF USE.....</b>	<b>7</b>
<b>3. SAFETY INSTRUCTIONS.....</b>	<b>8</b>
3.1 Installation.....	8
3.2 Electrical connection.....	9
3.3 Use.....	9
3.4 Care and cleaning.....	10
3.5 Pyrolytic cleaning.....	10
3.6 Steam Cooking.....	11
3.7 Internal lighting.....	11
3.8 Service.....	11
3.9 Disposal.....	11
<b>4. PRODUCT DESCRIPTION.....</b>	<b>13</b>
4.1 General overview.....	13
4.2 Accessories.....	13
<b>5. HOW TO TURN OVEN ON AND OFF.....</b>	<b>15</b>
5.1 Control panel.....	15
5.2 Display.....	15
<b>6. BEFORE FIRST USE.....</b>	<b>17</b>
6.1 Initial Cleaning .....	17
6.2 First connection.....	17
6.3 Initial preheating.....	17
6.4 How to set: Water hardness.....	17
<b>7. DAILY USE.....</b>	<b>19</b>
7.1 How to set: Heating functions.....	19
7.2 How to set: Steam heating function.....	19
7.3 How to set: Assisted cooking.....	20
7.4 Heating functions.....	21
7.5 Notes on: Moist Fan Baking.....	23
<b>8. CLOCK FUNCTIONS.....</b>	<b>24</b>
8.1 Clock functions description.....	24
8.2 How to set: Clock functions.....	24
<b>9. HOW TO USE: ACCESSORIES.....</b>	<b>27</b>
9.1 Inserting accessories.....	27
9.2 Using telescopic runners.....	27
9.3 Using Trivet and Grill- / Roasting pan.....	28
9.4 Food Sensor.....	29
<b>10. ADDITIONAL FUNCTIONS.....</b>	<b>32</b>
10.1 How to save: Favourites.....	32
10.2 Automatic switch-off.....	32
10.3 Cooling fan.....	32

# CONTENTS

---

<b>11. HINTS AND TIPS.....</b>	<b>33</b>
11.1 Cooking recommendations.....	33
11.2 Moist Fan Baking.....	33
11.3 Moist Fan Baking - recommended accessories.....	34
11.4 Cooking tables for test institutes.....	34
<b>12. CARE AND CLEANING.....</b>	<b>37</b>
12.1 Notes on cleaning.....	37
12.2 How to remove: Shelf supports .....	37
12.3 How to use: Pyrolytic cleaning.....	38
12.4 Cleaning Reminder.....	39
12.5 How to use: Descaling.....	39
12.6 Descaling reminder.....	40
12.7 How to use: Rinsing.....	40
12.8 Drying reminder.....	41
12.9 How to use: Drying.....	41
12.10 How to use: Tank emptying.....	41
12.11 How to remove and install: Door.....	41
12.12 How to replace: Lamp.....	43
<b>13. TROUBLESHOOTING.....</b>	<b>44</b>
13.1 What to do if.....	44
13.2 How to manage: Error codes.....	44
13.3 Service data.....	45
<b>14. ENERGY EFFICIENCY.....</b>	<b>46</b>
14.1 Product Information and Product Information Sheet*.....	46
14.2 Energy saving.....	46
<b>15. MENU STRUCTURE.....</b>	<b>48</b>
15.1 Menu.....	48
15.2 Submenu for: Cleaning.....	48
15.3 Submenu for: Options.....	49
15.4 Submenu for: Setup.....	49
15.5 Submenu for: Service.....	50
<b>16. IT'S EASY!.....</b>	<b>51</b>
<b>17. TAKE A SHORTCUT!.....</b>	<b>53</b>
<b>18. WARRANTY .....</b>	<b>54</b>

# 1. SAFETY INFORMATION

---

Before the installation and use of the appliance, carefully read the supplied instructions. The manufacturer is not responsible for any injuries or damage that are the result of incorrect installation or usage. Always keep the instructions in a safe and accessible location for future reference.

## 1.1 Children and vulnerable people safety

- This appliance can be used by children aged from 8 years and above and persons with reduced physical, sensory or mental capabilities or lack of experience and knowledge if they have been given supervision or instruction concerning the use of the appliance in a safe way and understand the hazards involved. Children of less than 8 years of age and persons with very extensive and complex disabilities shall be kept away from the appliance unless continuously supervised.
- Do not let children play with the appliance.
- Keep all packaging away from children and dispose of it appropriately.
- **WARNING:** Keep children and pets away from the appliance when it operates or when it cools down. Accessible parts become hot during use.
- If the appliance has a child safety device, it should be activated.
- Children shall not carry out cleaning and user maintenance of the appliance without supervision.

## 1.2 General Safety

- Only a qualified person must install this appliance and replace the cable.
- **WARNING:** The appliance and its accessible parts become hot during use. Care should be taken to avoid touching heating elements.
- Always use oven gloves to remove or put in accessories or ovenware.

## SAFETY INFORMATION

---

- Before carrying out any maintenance, disconnect the appliance from the power supply.
- **WARNING:** Ensure that the appliance is switched off before replacing the lamp to avoid the possibility of electric shock.
- Do not use the appliance before installing it in the built-in structure.
- Do not use a steam cleaner to clean the appliance.
- Do not use harsh abrasive cleaners or sharp metal scrapers to clean the glass door since they can scratch the surface, which may result in shattering of the glass.
- If the mains power supply cable is damaged, it must be replaced by the manufacturer, its Authorised Service Centre or similarly qualified persons to avoid an electrical hazard.
- Excessive spillage must be removed before the pyrolytic cleaning. Remove all parts from the oven.
- To remove the shelf supports first pull the front of the shelf support and then the rear end away from the side walls. Install the shelf supports in the opposite sequence.
- The means for disconnection must be incorporated in the fixed wiring in accordance with the wiring rules.
- Use only the food sensor (core temperature sensor) recommended for this appliance.

## **2. CONDITIONS OF USE**

---

This appliance is intended to be used in household and similar applications such as:

- Farm houses
- By clients in serviced apartments, holiday apartments and other residential type environments.

# 3. SAFETY INSTRUCTIONS

## 3.1 Installation

 **WARNING!**

Only a qualified person must install this appliance.

- Remove all the packaging.
- Do not install or use a damaged appliance.
- Follow the installation instructions supplied with the appliance.
- Always take care when moving the appliance as it is heavy. Always use safety gloves and enclosed footwear.
- Do not pull the appliance by the handle.
- Install the appliance in a safe and suitable place that meets installation requirements.
- Keep the minimum distance from other appliances and units.
- Before mounting the appliance, check if the oven door opens without restraint.
- The appliance is equipped with an electric cooling system. It must be operated with the electric power supply.
- The built-in unit must meet the stability requirements of DIN 68930.

Cabinet minimum height (Cabinet under the work-top minimum height)	578 (600) mm
Cabinet width	560 mm
Cabinet depth	550 (550) mm
Height of the front of the appliance	594 mm
Height of the back of the appliance	576 mm
Width of the front of the appliance	595 mm
Width of the back of the appliance	559 mm
Depth of the appliance	567 mm
Built in depth of the appliance	546 mm
Depth with open door	1027 mm
Ventilation opening minimum size. Opening placed on the bottom rear side	560 x 20 mm
Mounting screws	4 x 25 mm



## 3.2 Electrical connection

### **WARNING!**

Risk of fire and electric shock.

- All electrical connections should be made by a qualified electrician.
- The appliance must be earthed.
- Make sure that the parameters on the rating plate are compatible with the electrical ratings of the mains power supply.
- Always use a correctly installed shockproof socket.
- Do not use multi-plug adapters and extension cables.
- Make sure not to cause damage to the mains plug and to the mains cable. Should the mains cable need to be replaced, this must be carried out by our Authorised Service Centre.
- Do not let mains cables touch or come near the appliance door or the niche below the appliance, especially when it operates or the door is hot.
- The shock protection of live and insulated parts must be fastened in such a way that it cannot be removed without tools.
- Connect the mains plug to the mains socket only at the end of the installation. Make sure that there is access to the mains plug after the installation.
- If the mains socket is loose, do not connect the mains plug.
- Do not pull the mains cable to disconnect the appliance. Always pull the mains plug.
- Use only correct isolation devices: line protecting cut-outs, fuses (screw type fuses removed from the holder), earth leakage trips and contactors.
- The electrical installation must have an isolation device which lets you disconnect the appliance from the mains at all poles. The isolation device must have a contact opening width of minimum 3 mm.
- Fully close the appliance door before you connect the mains plug to the mains socket.
- This appliance is supplied without a main plug and a main cable.

## 3.3 Use

### **WARNING!**

Risk of injury, burns and electric shock or explosion.

- Do not change the specification of this appliance.
- Make sure that the ventilation openings are not blocked.
- Do not let the appliance stay unattended during operation.
- Deactivate the appliance after each use.
- Be careful when you open the appliance door while the appliance is in operation. Hot air can release.
- Do not operate the appliance with wet hands or when it has contact with water.
- Do not apply pressure on the open door.
- Do not use the appliance as a work surface or as a storage surface.
- Open the appliance door carefully. The use of ingredients with alcohol can cause a mixture of alcohol and air.
- Do not let sparks or open flames to come in contact with the appliance when you open the door.
- Do not put flammable products or items that are wet with flammable products in, near or on the appliance.

# SAFETY INSTRUCTIONS

---

## **WARNING!**

Risk of damage to the appliance.

- To prevent damage or discoloration to the enamel:
  - do not put ovenware or other objects in the appliance directly on the bottom.
  - do not put aluminium foil directly on the bottom of cavity of the appliance.
  - do not put water directly into the hot appliance.
  - do not keep moist dishes and food in the appliance after you finish the cooking.
  - be careful when you remove or install the accessories.
- Discoloration of the enamel or stainless steel has no effect on the performance of the appliance.
- Use a deep pan for moist cakes. Fruit juices cause stains that can be permanent.
- This appliance is for cooking purposes only. It must not be used for other purposes, for example room heating.
- Always cook with the oven door closed.
- If the appliance is installed behind a furniture panel (e.g. a door) make sure the door is never closed when the appliance operates. Heat and moisture can build up behind a closed furniture panel and cause subsequent damage to the appliance, the housing unit or the floor. Do not close the furniture panel until the appliance has cooled down completely after use.

## 3.4 Care and cleaning

### **WARNING!**

Risk of injury, fire, or damage to the appliance.

- Before maintenance, deactivate the appliance and disconnect the mains plug from the mains socket.
- Make sure the appliance is cold. There is the risk that the glass panels can break.
- Replace immediately the door glass panels when they are damaged. Contact the Authorised Service Centre.
- Be careful when you remove the door from the appliance. The door is heavy!
- Clean regularly the appliance to prevent the deterioration of the surface material.
- Clean the appliance with a moist soft cloth. Use only neutral detergents. Do not use abrasive products, abrasive cleaning pads, solvents or metal objects.
- If you use an oven spray, follow the safety instructions on its packaging.

## 3.5 Pyrolytic cleaning

### **WARNING!**

Risk of Injury / Fires / Chemical Emissions (Fumes) in Pyrolytic Mode.

- Before carrying out a Pyrolytic self-cleaning function or the First Use please remove from the oven cavity:
  - any excess food residues, oil or grease spills / deposits.
  - any removable objects (including shelves, side rails etc., provided with the product) particularly any non-stick pots, pans, trays, utensils etc.
- Read carefully all the instructions for Pyrolytic cleaning.
- Keep children away from the appliance while the Pyrolytic cleaning operates. The appliance becomes very hot and hot air is released from the front cooling vents.

- Pyrolytic cleaning is a high temperature operation that can release fumes from cooking residues and construction materials, as such consumers are strongly advised to:
  - provide good ventilation during and after each Pyrolytic cleaning.
  - provide good ventilation during and after the first use at maximum temperature operation.
- Unlike all humans, some birds and reptiles can be extremely sensitive to potential fumes emitted during the cleaning process of all Pyrolytic Ovens.
  - Remove any pets (especially birds) from the vicinity of the appliance location during and after the Pyrolytic cleaning and first use maximum temperature operation to a well ventilated area.
- Small pets can also be highly sensitive to the localized temperature changes in the vicinity of all Pyrolytic Ovens when the Pyrolytic self cleaning program is in operation.
- Non-stick surfaces on pots, pans, trays, utensils etc., can be damaged by the high temperature Pyrolytic cleaning operation of all Pyrolytic Ovens and can be also a source for low level harmful fumes.
- Fumes released from all Pyrolytic Ovens / Cooking Residues as described are not harmful to humans, including children, or persons with medical conditions.

## 3.6 Steam Cooking

### **WARNING!**

Risk of burns and damage to the appliance.

- Released Steam can cause burns:
  - Be careful when you open the appliance door when the function is activated. Steam can release.
  - Open the appliance door with care after the steam cooking operation.

## 3.7 Internal lighting

### **WARNING!**

Risk of electric shock.

- Concerning the lamp(s) inside this product and spare part lamps sold separately: These lamps are intended to withstand extreme physical conditions in household appliances, such as temperature, vibration, humidity, or are intended to signal information about the operational status of the appliance. They are not intended to be used in other applications and are not suitable for household room illumination.
- Use only lamps with the same specifications.

## 3.8 Service

- To repair the appliance contact the Authorised Service Centre.
- Use original spare parts only.

## 3.9 Disposal

### **WARNING!**

Risk of injury or suffocation.

- Disconnect the appliance from the mains supply.
- Cut off the mains electrical cable close to the appliance and dispose of it.

# SAFETY INSTRUCTIONS

---

- Remove the door catch to prevent children or pets from becoming trapped in the appliance.

# 4. PRODUCT DESCRIPTION

## 4.1 General overview

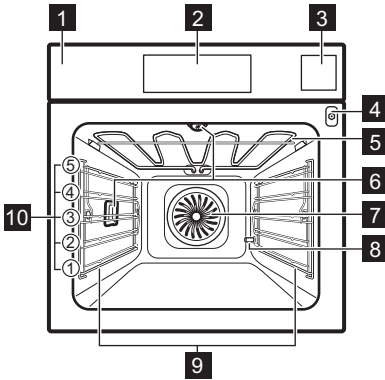

- 1** Control panel
- 2** Display
- 3** Water drawer
- 4** Socket for the food sensor
- 5** Heating element
- 6** Lamp
- 7** Fan
- 8** Descaling pipe outlet
- 9** Shelf support, removable
- 10** Shelf positions

## 4.2 Accessories

### Wire shelf

For cookware, cake tins, roasts.

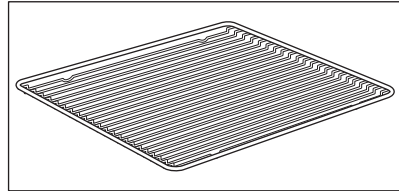

### Baking tray

For cakes and biscuits.

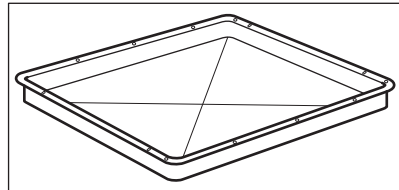

### Grill- / Roasting pan

To bake and roast or as a pan to collect fat.

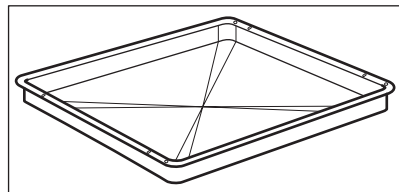

# PRODUCT DESCRIPTION

---

## Trivet

For roasting and grilling.  
Use the trivet only with the Grill- / Roasting pan.

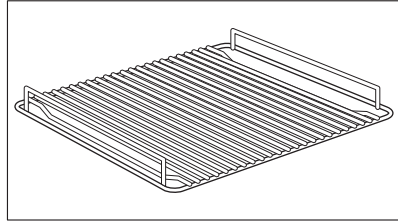

## Food sensor

To measure the temperature inside food.

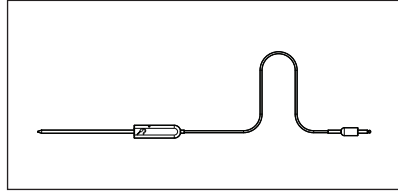

## Telescopic runners

For inserting and removing trays and wireshelf more easily.

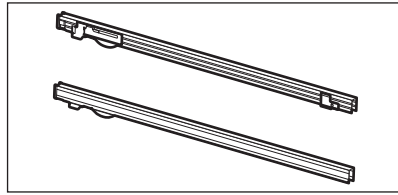

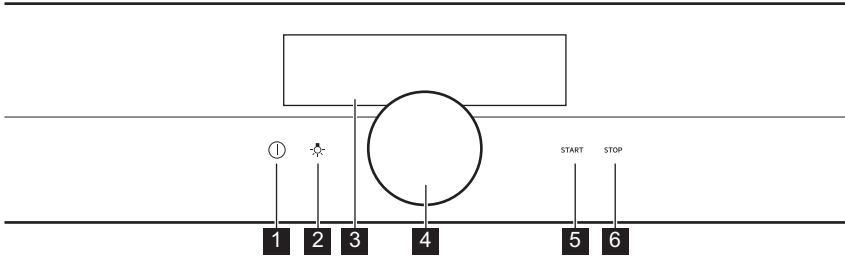

# 5. HOW TO TURN OVEN ON AND OFF

## 5.1 Control panel



<b>1</b>	On / Off	Press and hold to turn the oven on and off.
<b>2</b>	Lamp switch	To turn the lamp on and off.
<b>3</b>	Display	Shows the current settings of the oven.
<b>4</b>	Rotary knob	To operate the oven.
<b>5</b>	START	To turn on the selected function.
<b>6</b>	STOP	To turn off the selected function.





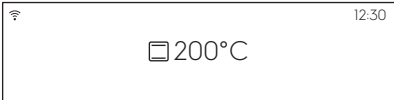

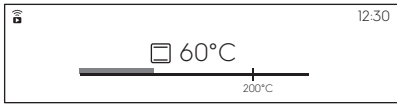
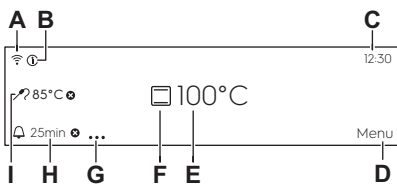

 <b>Hold</b>	 <b>Press</b>	 <b>Hold and turn</b>
Turn on the main screen.	Confirm a setting or enter the selected submenu.	Adjust settings and navigate through the menu.

## 5.2 Display

	<p>After turning on, the display shows the main screen with the heating function and the default temperature.</p>
---	---

# HOW TO TURN OVEN ON AND OFF

	<p>If you do not use the oven for 2 minutes, the display goes to standby.</p>
	<p>When you cook, the display shows the set functions and other available options.</p>
	<p>The display with the maximum number of functions set.</p> <ul style="list-style-type: none"> <li>A. Wi-Fi (selected models only)</li> <li>B. Information</li> <li>C. Time of day</li> <li>D. Menu</li> <li>E. Temperature</li> <li>F. Heating functions</li> <li>G. Timer options</li> <li>H. Timer</li> <li>I. Food sensor (selected models only)</li> </ul>

<h3>Display indicators</h3>				
<p><b>Sound alarm function indicators</b> - when the set time of cooking ends, the signal sounds.</p>				
 The function is on.	 The function is on. Cooking stops automatically.	 Sound alarm is off.		
<h3>Timer indicators</h3>				
 The timer starts at a later time.	 The timer starts after closing the oven door.	 To cancel the setting.	 The timer starts when the oven reaches the set temperature.	 The timer starts when cooking starts.
<h3>Door function indicators</h3>				
 The oven door is locked.				





## 6. BEFORE FIRST USE

### **WARNING!**

Refer to Safety chapters.

### 6.1 Initial Cleaning

		
<b>Step 1</b>	<b>Step 2</b>	<b>Step 3</b>
Remove all accessories and removable shelf supports from the oven.	Clean the oven and the accessories with a soft cloth, warm water and a mild detergent.	Place the accessories and the removable shelf supports in the oven.



### 6.2 First connection

The display shows welcome message after the first connection.  
You have to set: Language, Display brightness, Buzzer volume, Time of day.

### 6.3 Initial preheating







**Preheat the empty oven before the first use.**

<b>Step 1</b>	Remove all accessories and removable shelf supports from the oven.
<b>Step 2</b>	Set the maximum temperature for the function:  Let the oven operate for 1 h.
<b>Step 3</b>	Set the maximum temperature for the function:  Let the oven operate for 15 min.
 The oven can emit an odour and smoke during preheating. Make sure that the room is ventilated.	

### 6.4 How to set: Water hardness





When you connect the oven to the mains you have to set the water hardness level.  
Use the test paper or contact your water supplier to check the water hardness level.

			
---	---	---	---

# BEFORE FIRST USE

Step 1	Step 2	Step 3	Step 4
Put the test paper into water for about 1 sec. Do not put the test paper under running water.	Shake the test paper to remove the excess of water.	After 1 min, check water hardness with the table below.	Set the water hardness level: Menu / Settings / Setup / Water hardness.
<p>① The colours of the test paper continue to change. Do not check water hardness later than 1 min after test.</p>			
<p>You can change the water hardness level in the menu: Settings / Setup / Water hardness.</p>			

The table shows water hardness range (dH) with the corresponding level of Calcium deposit and the water classification. Adjust the water hardness level according to the table.

Water hardness		Test paper	Calcium deposit (mmol/l)	Calcium deposit (mg/l)	Water classification
Level	dH				
1	0 - 7		0 - 1.3	0 - 50	soft
2	8 - 14		1.4 - 2.5	51 - 100	moderately hard
3	15 - 21		2.6 - 3.8	101 - 150	hard
4	≥22		≥ 3.9	≥151	very hard

When the tap water hardness level is 4, fill the water drawer with still bottled water.

## 7. DAILY USE

### **WARNING!**

Refer to Safety chapters.

### 7.1 How to set: Heating functions

<b>Step 1</b>	Turn on the oven.
<b>Step 2</b>	Hold the knob. The display shows the default heating functions.
<b>Step 3</b>	Select the symbol of the heating function and press the knob to enter the submenu.
<b>Step 4</b>	Select the heating function and press the knob.
<b>Step 5</b>	Select: °C. Press the knob. The display shows the temperature settings.
<b>Step 6</b>	Turn and press the knob to set the temperature .
<b>Step 7</b>	Press: START . Food Sensor - you can plug the sensor at any time before or during cooking.
STOP - press to turn off the heating function.	
<b>Step 8</b>	Turn off the oven.

#### Take a shortcut!



### 7.2 How to set: Steam heating function

<b>Step 1</b>	Turn on the oven.
<b>Step 2</b>	Select:  . Press the knob to set the steam heating function.
<b>Step 3</b>	Select: °C. Press the knob to set the temperature. The display shows the temperature settings.
<b>Step 4</b>	Set the temperature and press the knob to confirm.
<b>Step 5</b>	Press the cover of the water drawer to open it.

<p><b>Step 6</b></p>	<p>Fill the water drawer with cold water to the maximum level (around 950 ml) until the signal sounds or the display shows the message. Do not fill the water drawer over its maximum capacity. There is a risk of water leakage, overflow and furniture damage.</p> <div style="border: 1px solid black; padding: 5px; margin-top: 10px;"> <p> <b>WARNING!</b> Use only cold tap water. Do not use filtered (demineralised) or distilled water. Do not use other liquids. Do not pour flammable or alcoholic liquids into the water drawer.</p> </div>
<p><b>Step 7</b></p>	<p>Push the water drawer to its initial position.</p>
<p><b>Step 8</b></p>	<p>Press: START . Steam appears after approximately 2 min. When the oven reaches the set temperature, the signal sounds.</p>
<p><b>Step 9</b></p>	<p>When the water drawer runs out of water, the signal sounds. Refill the water drawer. The signal sounds at the end of the cooking time.</p>
<p><b>Step 10</b></p>	<p>Turn off the oven.</p>
<p><b>Step 11</b></p>	<p>Empty the water drawer after cooking ends. Refer to "Care and Cleaning" chapter, Tank emptying.</p>
<p><b>Step 12</b></p>	<p>Residual water can condensate in the cavity. After cooking, carefully open the door. When the oven is cold, dry the cavity with a soft cloth.</p>

## Take a shortcut!



## 7.3 How to set: Assisted cooking

Every dish in this submenu has a recommended function and temperature. You can adjust the time and the temperature.

For some of the dishes you can also cook with:

- Weight Automatic
- Food Sensor

The degree to which a dish is cooked:

- Rare or Less
- Medium
- Well done or More

<p><b>Step 1</b></p>	<p>Turn on the oven.</p>
----------------------	--------------------------





<b>Step 2</b>	Select: Menu. Press the knob.
<b>Step 3</b>	Select: Assisted cooking. Press the knob.
<b>Step 4</b>	Choose a dish or a food type and press the knob to confirm.
<b>Step 5</b>	Press: START .



## Take a shortcut!









## 7.4 Heating functions



### Standard heating functions

Heating function	Application
 <b>Grill</b>	To grill thin pieces of food and to toast bread.
 <b>Turbo Grilling</b>	To roast large meat joints or poultry with bones on one shelf position. To make gratins and to brown.
 <b>True Fan Cooking</b>	To bake on up to three shelf positions at the same time and to dry food. Set the temperature 20 - 40 °C lower than for Conventional Cooking.
 <b>Frozen Foods</b>	To make convenience food (e.g., french fries, potato wedges or spring rolls) crispy.
 <b>Conventional Cooking</b>	To bake and roast food on one shelf position.



Heating function	Application
 <p><b>Pizza Function</b></p>	To bake pizza. To make intensive browning and a crispy bottom.
 <p><b>Bottom Heat</b></p>	To bake cakes with crispy bottom and to preserve food.

## Special heating functions

Heating function	Application
 <p><b>Preserving</b></p>	To preserve vegetables (e.g., pickles).
 <p><b>Dehydrating</b></p>	To dry sliced fruit, vegetables and mushrooms.
 <p><b>Plate Warming</b></p>	To preheat plates for serving.
 <p><b>Defrost</b></p>	To defrost food (vegetables and fruit). The defrosting time depends on the amount and size of the frozen food.
 <p><b>Au Gratin</b></p>	For dishes such as lasagna or potato gratin. To make gratins and to brown.
 <p><b>Slow Cooking</b></p>	To prepare tender, succulent roasts.
 <p><b>Keep Warm</b></p>	To keep food warm.

Heating function	Application
 <b>Moist Fan Baking</b>	<p>This function is designed to save energy during cooking. When you use this function, the temperature in the cavity may differ from the set temperature. The residual heat is used. The heating power may be reduced. For more information refer to "Daily Use" chapter, Notes on: Moist Fan Baking.</p>
 <b>Dough Proving</b>	<p>To speed up the rising of the yeast dough. It prevents dough surface from drying and keeps the dough elastic.</p>

## Steam heating functions

Heating function	Application
 <b>Humidity Low</b>	<p>The function is suitable for meat, poultry, oven dishes and casseroles. Thanks to the combination of steam and heat, meat gets a tender and juicy texture along with a crusty surface.</p>
 <b>Steam Regenerating</b>	<p>Food reheating with steam prevents surface drying. Heat is distributed in a gentle and even way, which allows to recover taste and aroma of food as just prepared. This function can be used to reheat food directly on a plate. You can reheat more than one plate at the same time, using different shelf positions.</p>
 <b>Bread Baking</b>	<p>Use this function to prepare bread and bread rolls with a very good professional-like result in terms of crispiness, colour and crust gloss.</p>

### 7.5 Notes on: Moist Fan Baking

This function was used to comply with the energy efficiency class and ecodesign requirements according to EU 65/2014 and EU 66/2014. Tests according to EN 60350-1.

The oven door should be closed during cooking so that the function is not interrupted and the oven operates with the highest energy efficiency possible.





When you use this function the lamp automatically turns off after 30 sec.

For the cooking instructions refer to "Hints and tips" chapter, Moist Fan Baking. For general energy saving recommendations refer to "Energy Efficiency" chapter, Energy Saving.

# 8. CLOCK FUNCTIONS

## 8.1 Clock functions description

Clock function	Application
Cooking time	To set the length of cooking. Maximum is 23 h 59 min.
Start criteria	To set when the timer starts counting.
End action	To set what happens when the timer ends counting.
Delayed start	To postpone the start and / or end of cooking.
Time extension	To extend cooking time.
Reminder	To set a countdown. Maximum is 23 h 59 min. This function has no effect on the operation of the oven.

Start criteria	Comment
-	The timer starts when you turn it on.
	The timer starts after closing the door.
	The timer starts when cooking starts.
	The timer starts when the oven reaches the set temperature.
	The timer starts at a specific time.

## 8.2 How to set: Clock functions

How to set the clock	
<b>Step 1</b>	Select: Time of day. Press the knob.
<b>Step 2</b>	Turn the knob to set the clock. Press the knob.

How to set cooking time	
<b>Step 1</b>	Select a heating function and set the temperature.



How to set cooking time	
<b>Step 2</b>	Select: Timer.
<b>Step 3</b>	Turn the knob to set the time. Press the knob.
<b>Step 4</b>	Select: End action. Press the knob. Timer starts counting down immediately.

## Take a shortcut!



How to choose cooking start / end option	
<b>Step 1</b>	Choose a heating function and set the temperature.
<b>Step 2</b>	Select: ● ● ● . Press the knob.
<b>Step 3</b>	Select: Start criteria. Press the knob.
<b>Step 4</b>	Select: End action. Press the knob.

How to delay start and end of cooking	
<b>Step 1</b>	Select: ● ● ● . Press the knob.
<b>Step 2</b>	Select: Start criteria / At a later time. Press the knob.
<b>Step 3</b>	Turn the knob to set the start time. Press the knob.
<b>Step 4</b>	Turn the knob to set the end of cooking. Press the knob.
<b>Step 5</b>	Select: End action. Press the knob.

How to delay start without setting the end of cooking	
<b>Step 1</b>	Select: ● ● ● . Press the knob.

# CLOCK FUNCTIONS

---

## How to delay start without setting the end of cooking

<b>Step 2</b>	Select: Start criteria / At a later time.
<b>Step 3</b>	Turn the knob to set the start time. Press the knob twice to confirm.

## How to extend cooking time

When 10% of cooking time is left and the food seems not to be ready, you can extend cooking time. You can also change the oven function.

<b>Step 1</b>	Select: Timer.
<b>Step 2</b>	Select preferred time icon to extend cooking time and press the knob to confirm.
<b>Step 3</b>	Also, you can select the preferred heating function and press the knob to change it.

## 9. HOW TO USE: ACCESSORIES

### 9.1 Inserting accessories

A small indentation at the top increases safety. The indentations are also anti-tip devices. The high rim around the shelf prevents cookware from slipping off the shelf.

**Wire shelf:**

Push the shelf between the guide bars of the shelf support.

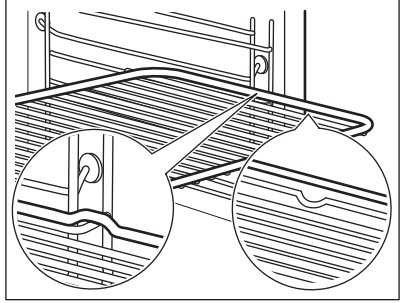

**Baking tray / Deep pan:**

Push the tray between the guide bars of the shelf support.

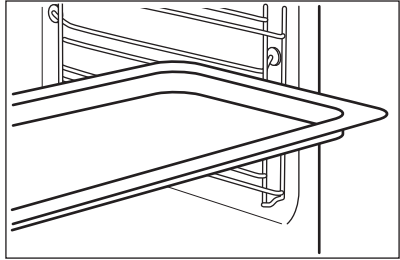

**Wire shelf, Baking tray / Deep pan:**

Push the tray between the guide bars of the shelf support and the wire shelf on the guide bars above.

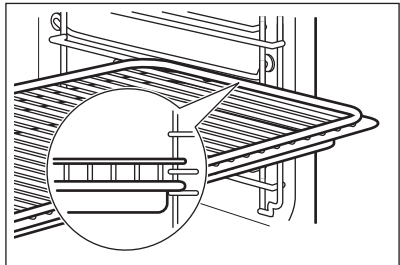

### 9.2 Using telescopic runners

Do not oil the telescopic runners.

Make sure you push back the telescopic runners fully in the oven before you close the oven door.

# HOW TO USE: ACCESSORIES

## Wire shelf:

Put the wire shelf on the telescopic runners.

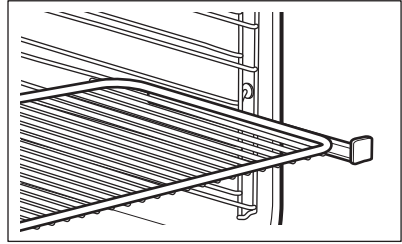

## Deep pan:

Put the deep pan on the telescopic runners.

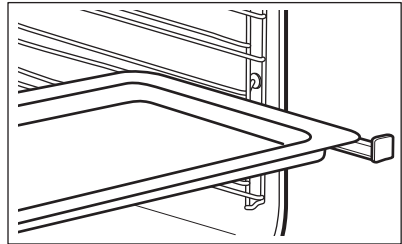

## Wire shelf and deep pan together:

Place the wire shelf and the deep pan together on the telescopic runner.

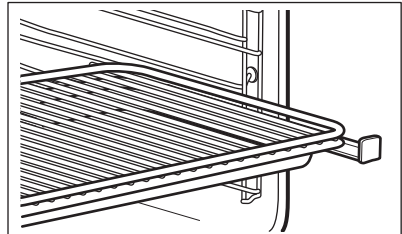

## 9.3 Using Trivet and Grill- / Roasting pan

### **WARNING!**

Be careful when you remove the accessories from a hot oven. There is a risk of burns.

You can use the trivet to roast larger pieces of meat or poultry on one shelf position.

# HOW TO USE: ACCESSORIES

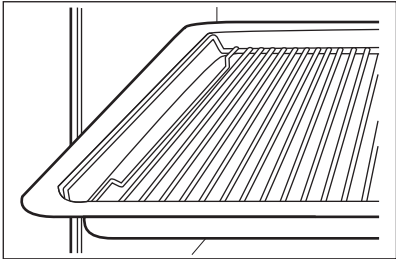
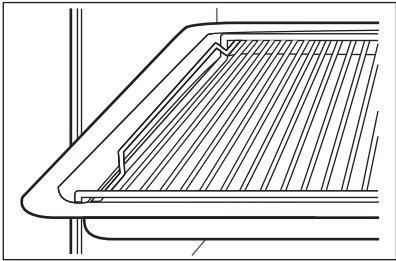
<p><b>Step 1</b></p>	<p>Put the trivet into the deep pan so that the supports of the wire shelf point up.</p>	
<p><b>Step 2</b> Put the deep pan into the oven on the necessary shelf position.</p>		
<p>You can use the trivet to grill flat dishes in large quantities and to toast.</p>		
<p><b>Step 1</b></p>	<p>Put the trivet into the deep pan so that the supports of the wire shelf point down.</p>	
<p><b>Step 2</b> Put the deep pan into the oven on the necessary shelf position.</p>		

## 9.4 Food Sensor

Food Sensor- measures the temperature inside the food. You can use it with every heating function.



<p><b>There are two temperatures to be set:</b></p>	
<p style="text-align: center;">°C</p> <p>The oven temperature: minimum 120 °C.</p>	<p style="text-align: center;"></p> <p>The core temperature.</p>

<p><b>For the best cooking results:</b></p>		
<p>Ingredients should be at room temperature.</p>	<p>Do not use it for liquid dishes.</p>	<p>During cooking it must remain in the dish.</p>

The oven calculates an approximate end of cooking time. It depends on the quantity of food, the set oven function and the temperature.

# HOW TO USE: ACCESSORIES

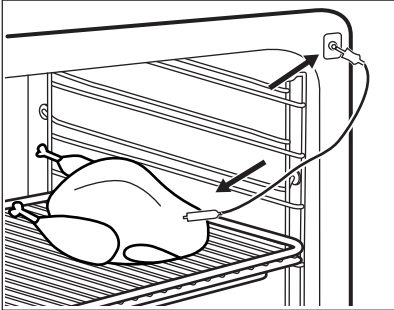
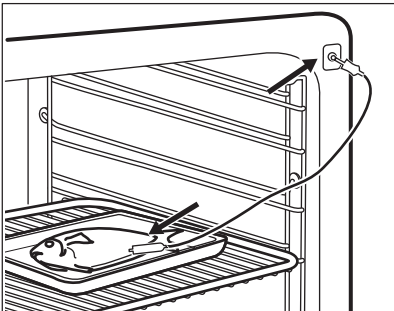
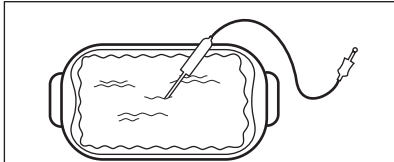
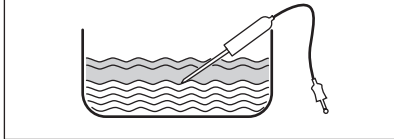
## How to use: Food Sensor

<b>Step 1</b>	Turn on the oven.
<b>Step 2</b>	Set a heating function and, if necessary, the oven temperature.
<b>Step 3</b>	Insert: Food Sensor.
<b>Meat, poultry and fish</b>	<b>Casserole</b>
<p>Insert the tip of Food Sensor into the centre of meat, fish, in the thickest part if possible. Make sure that at least 3/4 of Food Sensor is inside of the dish.</p>  	<p>Insert the tip of Food Sensor exactly in the centre of the casserole. Food Sensor should be stabilized in one place during baking. Use a solid ingredient to achieve that. Use the rim of the baking dish to support the silicone handle of Food Sensor. The tip of Food Sensor should not touch the bottom of a baking dish. Cover Food Sensor with the remaining ingredients.</p>  
<b>Step 4</b>	Plug Food Sensor into the socket at the front of the oven. The display shows the current temperature of: Food Sensor.
<b>Step 5</b>	 - select and press the knob to set the core temperature of the sensor.
<b>Step 6</b>	Press the knob to set the preferred sensor option: <ul style="list-style-type: none"><li>• Sound alarm - when food reaches the core temperature, the signal sounds.</li><li>• Sound alarm and stop cooking - when food reaches the core temperature, the signal sounds and the oven stops.</li></ul>

# HOW TO USE: ACCESSORIES

<b>Step 7</b>	Turn the knob to select the option. Press the knob to confirm.
<b>Step 8</b>	Press: START . When food reaches the set temperature, the signal sounds. You can choose to stop or to continue cooking to make sure the food is well done.
<b>Step 9</b>	Remove Food Sensor plug from the socket and remove the dish from the oven. <div style="border: 1px solid black; padding: 5px;"><p> <b>WARNING!</b> There is a risk of burns as Food Sensor becomes hot. Be careful when you unplug it and remove it from the food.</p></div>

## Take a shortcut!



# 10. ADDITIONAL FUNCTIONS



## 10.1 How to save: Favourites

You can save your favourite settings, such as the heating function, the cooking time, the temperature or the cleaning function. You can save 3 favourite settings. Saved settings are available in the menu: Favourites.

<b>Step 1</b>	Turn on the oven.
<b>Step 2</b>	Select the preferred setting and press the knob.
<b>Step 3</b>	Select: Menu / Favourites.
<b>Step 4</b>	Select: Save current settings. Turn the knob to select the position of the setting.
<b>Step 5</b>	Press the knob to add the setting to the list of: Favourites.

## 10.2 Automatic switch-off

For safety reasons the oven turns off after some time, if a heating function works and you do not change any settings.

 (°C)	 (h)
30 - 115	12.5
120 - 195	8.5
200 - 245	5.5
250 - maximum	3

The Automatic switch-off does not work with the functions: Light, Food sensor, End time, Slow Cooking.

## 10.3 Cooling fan

When the oven operates, the cooling fan turns on automatically to keep the surfaces of the oven cool. If you turn off the oven, the cooling fan can continue to operate until the oven cools down.



# 11. HINTS AND TIPS

## **WARNING!**

Refer to Safety chapters.

## 11.1 Cooking recommendations







The temperature and cooking times in the tables are guidelines only. They depend on the recipes and the quality and quantity of the ingredients used.

Your oven may bake or roast differently to the oven you had before. The tables below show recommended settings for temperature, cooking time and shelf position for specific types of the food. If you cannot find the settings for a special recipe, look for the similar one.





For more cooking recommendations refer to cooking tables on our website. To find the Cooking Hints check the PNC number on the rating plate on the front frame of the oven cavity.

## 11.2 Moist Fan Baking

For the best results follow suggestions listed in the table below.



		 (°C)		 (min)
Sweet rolls, 16 pieces	baking tray or dripping pan	180	2	25 - 35
Swiss roll	baking tray or dripping pan	180	2	15 - 25
Whole fish, 0.2 kg	baking tray or dripping pan	180	3	15 - 25
Cookies, 16 pieces	baking tray or dripping pan	180	2	20 - 30
Macaroons, 24 pieces	baking tray or dripping pan	160	2	25 - 35
Muffins, 12 pieces	baking tray or dripping pan	180	2	20 - 30
Savory pastry, 20 pieces	baking tray or dripping pan	180	2	20 - 30

# HINTS AND TIPS

		 (°C)		 (min)
Short crust biscuits, 20 pieces	baking tray or dripping pan	140	2	15 - 25
Tartlets, 8 pieces	baking tray or dripping pan	180	2	15 - 25

## 11.3 Moist Fan Baking - recommended accessories

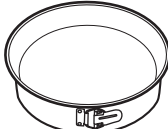





Use the dark and non-reflective tins and containers. They have better heat absorption than the light colour and reflective dishes.

			
<b>Pizza pan</b>	<b>Baking dish</b>	<b>Ramekins</b>	<b>Flan base tin</b>
Dark, non-reflective 28 cm diameter	Dark, non-reflective 26 cm diameter	Ceramic 8 cm diameter, 5 cm height	Dark, non-reflective 28 cm diameter

## 11.4 Cooking tables for test institutes





### Information for test institutes

Tests according to: EN 60350, IEC 60350.

 <b>BAKING ON ONE LEVEL. Baking in tins</b>				
		 (°C)	 (min)	
Fatless sponge cake	True Fan Cooking	140 - 150	35 - 50	2
Fatless sponge cake	Conventional Cooking	160	35 - 50	2
Apple pie, 2 tins Ø20 cm	True Fan Cooking	160	60 - 90	2



## BAKING ON ONE LEVEL. Baking in tins





		 (°C)	 (min)	
Apple pie, 2 tins Ø20 cm	Conventional Cooking	180	70 - 90	1



## BAKING ON ONE LEVEL. Biscuits







Use the third shelf position.







		 (°C)	 (min)
Short bread / Pastry strips	True Fan Cooking	140	25 - 40
Short bread / Pastry strips, preheat the empty oven	Conventional Cooking	160	20 - 30
Small cakes, 20 per tray, preheat the empty oven	True Fan Cooking	150	20 - 35
Small cakes, 20 per tray, preheat the empty oven	Conventional Cooking	170	20 - 30









## MULTILEVEL BAKING. Biscuits

		 (°C)	 (min)	
Short bread / Pastry strips	True Fan Cooking	140	25 - 45	1 / 4
Small cakes, 20 per tray, preheat the empty oven	True Fan Cooking	150	23 - 40	1 / 4

# HINTS AND TIPS

 <b>MULTILEVEL BAKING. Biscuits</b>				
		 (°C)	 (min)	
Fatless sponge cake	True Fan Cooking	160	35 - 50	1 / 4

 <b>GRILL</b>				
 <b>Preheat the empty oven for 5 minutes.</b>				
 <b>Grill with the maximum temperature setting.</b>				
		 (min)		
Toast	Grill	1 - 3	5	
Beef steak, turn halfway through	Grill	24 - 30	4	

# 12. CARE AND CLEANING

**⚠ WARNING!**

Refer to Safety chapters.

## 12.1 Notes on cleaning

 <p><b>Cleaning Agents</b></p>	Clean the front of the oven with a soft cloth with warm water and a mild detergent.
	Use a cleaning solution to clean metal surfaces.
	Clean stains with a mild detergent.

 <p><b>Everyday Use</b></p>	Clean the cavity after each use. Fat accumulation or other residue may cause fire.
	Do not store the food in the oven for longer than 20 minutes. Dry the cavity with a soft cloth after each use.

 <p><b>Accessories</b></p>	Clean all accessories after each use and let them dry. Use a soft cloth with warm water and a mild detergent. Do not clean the accessories in a dishwasher.
	Do not clean the non-stick accessories using abrasive cleaner or sharp-edged objects.

## 12.2 How to remove: Shelf supports

Remove the shelf supports to clean the oven.

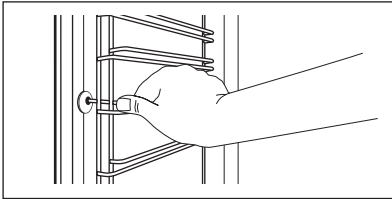
<b>Step 1</b>	Turn off the oven and wait until it is cold.	
<b>Step 2</b>	Carefully pull the shelf supports up and out of the front catch.	
<b>Step 3</b>	Pull the front end of the shelf support away from the side wall.	
<b>Step 4</b>	Pull the supports out of the rear catch.	

Install the shelf supports in the opposite sequence.

# CARE AND CLEANING

## 12.3 How to use: Pyrolytic cleaning

Clean the oven with pyrolytic cleaning.



### WARNING!

There is a risk of burns.



### CAUTION!

If there are other appliances installed in the same cabinet, do not use them at the same time as this function. It can cause damage to the oven.

#### Before the pyrolytic cleaning:

Turn off the oven and wait until it is cold.	Remove all accessories.	Clean the oven floor and the inner door glass with warm water, a soft cloth and a mild detergent.
--	-------------------------	---

Do not fill the water tank during cleaning. It restarts the cleaning cycle.

<b>Step 1</b>	Turn on the oven.
<b>Step 2</b>	Select: Menu / Cleaning.
<b>Step 3</b>	Put the baking tray on the first shelf position to collect water from the water tank. Press the knob to start water tank emptying.
<b>Step 4</b>	When the tank emptying ends wipe the oven cavity and the inner door glass with a soft cloth. Press the knob to continue cleaning.
<b>Step 5</b>	Select the cleaning mode. Press the knob to confirm.

Option	Cleaning mode	Duration
Quick	Light cleaning	1 h
Normal	Normal cleaning	1 h 30 min
Intense	Thorough cleaning	3 h



When the cleaning starts, the lamp is off and the cooling fan works at a higher speed.

**STOP** - press to stop the cleaning before it is completed.

Do not use the oven until the door lock symbol disappears from the display.

When the cleaning ends:		
Turn off the oven and wait until it is cold.	Clean the cavity with a soft cloth.	Remove the residue from the bottom of the cavity.

## 12.4 Cleaning Reminder

When the reminder appears, cleaning is necessary.
Use the function: Pyrolytic Cleaning.
You can enable and disable the reminder in the menu: Setup.

## 12.5 How to use: Descaling

Before you start:		
Turn off the oven and wait until it is cold.	Remove all accessories.	Make sure that the water drawer is empty.

<b>Duration of the first part:</b> around 100 min	
<b>Step 1</b>	Place the deep pan on the first shelf position.
<b>Step 2</b>	Pour 250 ml of the descaling agent in the water drawer.
<b>Step 3</b>	Fill the remaining part of the water drawer with water to the maximum level until the signal sounds or the display shows the message.
<b>Step 4</b>	Select: Menu / Cleaning.
<b>Step 5</b>	Turn on the function and follow the instruction on the display. The first part of descaling starts.
<b>Step 6</b>	After the first part is over, empty the deep pan and put it back on the first shelf position.
<b>Duration of the second part:</b> around 35 min	
<b>Step 7</b>	Fill the remaining part of the water drawer with water to the maximum level until the signal sounds or the display shows the message.

# CARE AND CLEANING

<b>Step 8</b>	When the function ends, remove the deep pan.
❗ When this function works, the lamp is off.	

When descaling ends:		
Turn off the oven.	When the oven is cold, dry the cavity with a soft cloth.	Leave the oven door open and wait until the cavity is dry.
❗ If some limestone residue remains in the oven after descaling, the display prompts to repeat the procedure.		

## 12.6 Descaling reminder

There are two reminders which prompt you to descale the oven. You cannot disable the descaling reminder.

Type	Description
Soft reminder	Recommends you to descale the oven.
Hard reminder	Obligates you to descale the oven. If you do not descale the oven when the hard reminder is on, the steam functions are disabled.
❗ These reminders activate each time you turn off the oven.	

## 12.7 How to use: Rinsing

Before you start:	
Turn off the oven and wait until it is cold.	Remove all accessories.

<b>Step 1</b>	Place the deep pan on the first shelf position.
<b>Step 2</b>	Fill the water drawer with water to the maximum level until the signal sounds or the display shows the message.
<b>Step 3</b>	Select: Menu / Cleaning / Rinsing. Duration: around 30 min
<b>Step 4</b>	Turn on the function and follow the instruction on the display.



<b>Step 5</b>	When the function ends, remove the deep pan.
 When this function works, the lamp is off.	

## 12.8 Drying reminder

After cooking with a steam heating function the display prompts to dry the oven. Press YES to dry the oven.

## 12.9 How to use: Drying

Use it after cooking with a steam heating function or steam cleaning to dry the cavity.

<b>Step 1</b>	Make sure the oven is cold.
<b>Step 2</b>	Remove all accessories.
<b>Step 3</b>	Select the menu: Cleaning / Drying.
<b>Step 4</b>	Follow the instructions on the screen.

## 12.10 How to use: Tank emptying

Use it after cooking with steam heating function to remove the residual water from the water drawer.

<b>Before you start:</b>	
Turn off the oven and wait until it is cold.	Remove all accessories.

<b>Step 1</b>	Place the deep pan on the first shelf position.
<b>Step 2</b>	Select: Menu / Cleaning / Tank emptying. Duration: 6 min
<b>Step 3</b>	Turn on the function and follow the instruction on the display.
<b>Step 4</b>	When the function ends, remove the deep pan.
 When this function works, the lamp is off.	

## 12.11 How to remove and install: Door

You can remove the door and the internal glass panels to clean it. The number of glass panels is different for different models.

# CARE AND CLEANING

**⚠ WARNING!**

The door is heavy.

**⚠ CAUTION!**

Carefully handle the glass, especially around the edges of the front panel. The glass can break.

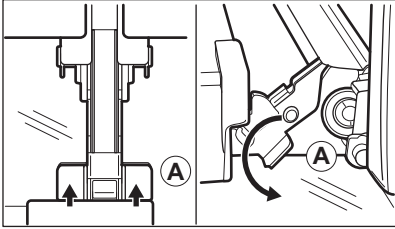
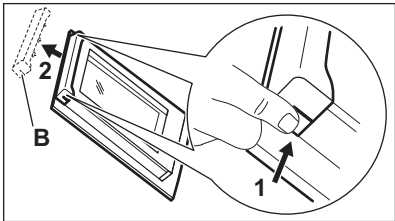
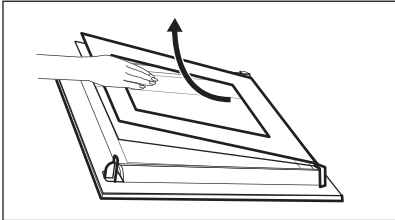
<p><b>Step 1</b></p>	<p>Fully open the door.</p>	
<p><b>Step 2</b></p>	<p>Lift and press the clamping levers (A) on the two door hinges.</p>	
<p><b>Step 3</b></p>	<p>Close the oven door to the first opening position (approximately 70° angle). Hold the door at both sides and pull it away from the oven at an upwards angle. Put the door with the outer side down on a soft cloth on a stable surface.</p>	
<p><b>Step 4</b></p>	<p>Hold the door trim (B) on the top edge of the door at the two sides and push inwards to release the clip seal.</p>	
<p><b>Step 5</b></p>	<p>Pull the door trim to the front to remove it.</p>	
<p><b>Step 6</b></p>	<p>Hold the door glass panels on their top edge one by one and pull them up out of the guide.</p>	
<p><b>Step 7</b></p>	<p>Clean the glass panel with water and soap. Dry the glass panel carefully. Do not clean the glass panels in the dishwasher.</p>	
<p><b>Step 8</b></p>	<p>After cleaning, do the above steps in the opposite sequence.</p>	
<p><b>Step 9</b></p>	<p>Install the smaller panel first, then the larger and the door.</p>	

## 12.12 How to replace: Lamp

### **WARNING!**

Risk of electric shock.  
The lamp can be hot.

#### Before you replace the lamp:

Step 1	Step 2	Step 3
Turn off the oven. Wait until the oven is cold.	Disconnect the oven from the mains.	Put a cloth on the bottom of the cavity.

### Top lamp

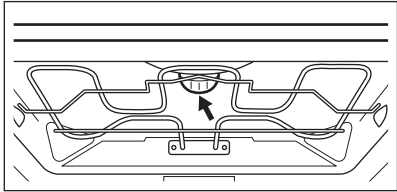
<b>Step 1</b>	Turn the glass cover to remove it.	
<b>Step 2</b>	Remove the metal ring and clean the glass cover.	
<b>Step 3</b>	Replace the lamp with a suitable 300 °C heat-resistant lamp.	
<b>Step 4</b>	Attach the metal ring to the glass cover and install it.	

### Side lamp

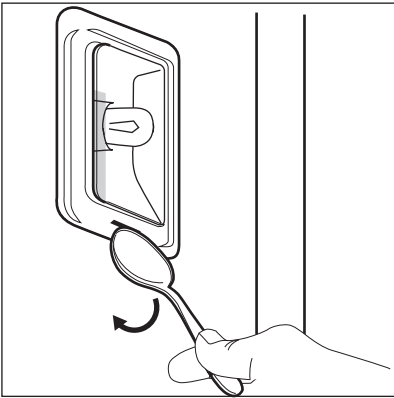
<b>Step 1</b>	Remove the left shelf support to get access to the lamp.	
<b>Step 2</b>	Use a narrow, blunt object (e.g. a teaspoon) to remove the glass cover.	
<b>Step 3</b>	Clean the glass cover.	
<b>Step 4</b>	Replace the lamp with a suitable 300 °C heat-resistant lamp.	
<b>Step 5</b>	Install the glass cover.	
<b>Step 6</b>	Install the left shelf support.	

# 13. TROUBLESHOOTING

**⚠ WARNING!**

Refer to Safety chapters.

## 13.1 What to do if...



**The oven does not turn on or does not heat up**



**Possible cause**



**Remedy**

The oven is not connected to an electrical supply or it is connected incorrectly.

Check if the oven is correctly connected to the electrical supply.

The clock is not set.

Set the clock, for details refer to "Clock Functions" chapter, How to set: Clock functions.

The door is not closed correctly.

Fully close the door.

The fuse is blown.

Make sure the fuse is the cause of the problem. If the problem recurs, contact a qualified electrician.

The oven Child Lock is on.

Refer to "Menu" chapter, Submenu for: Options.



**Components need to be replaced**



**Description**



**Remedy**

The lamp is burnt out.



Replace the lamp, for details refer to "Care and Cleaning" chapter, How to replace: Lamp.

Power cut always stops cleaning. Repeat cleaning if it's interrupted by power failure.

## 13.2 How to manage: Error codes

When the software error occurs, the display shows error message.

In this section, you will find the list of the problems that you can handle on your own.

 <b>Code and description</b>	 <b>Remedy</b>
C2 - the Food sensor is in the oven cavity during Pyrolytic Cleaning.	Take out the Food sensor.
C3 - the door is not fully closed during Pyrolytic Cleaning.	Close the door.
F111 - Food sensor is not correctly inserted into the socket.	Fully plug Food sensor into the socket.
F908 - the oven system cannot connect with the control panel.	Turn the oven off and on.

### 13.3 Service data

If you cannot find a solution to the problem yourself, contact your dealer or an Authorised Service Centre.

The necessary data for the service centre is on the rating plate. The rating plate is on the front frame of the oven cavity. Do not remove the rating plate from the oven cavity.

<b>We recommend that you write the data here:</b>	
Model (MOD.)	.....
Product number (PNC)	.....
Serial number (S.N.)	.....

# 14. ENERGY EFFICIENCY

## 14.1 Product Information and Product Information Sheet\*

Supplier's name	AEG
Model identification	BSK97733PT 944188472
Energy Efficiency Index	61.2
Energy efficiency class	A++
Energy consumption with a standard load, conventional mode	1.09 kWh/cycle
Energy consumption with a standard load, fan-forced mode	0.52 kWh/cycle
Number of cavities	1
Heat source	Electricity
Volume	71 l
Type of oven	Built-In Oven
Mass	40.5 kg

\* For European Union according to EU Regulations 65/2014 and 66/2014.  
For Republic of Belarus according to STB 2478-2017, Appendix G; STB 2477-2017, Annexes A and B.  
For Ukraine according to 568/32020.

Energy efficiency class is not applicable for Russia.

EN 60350-1 - Household electric cooking appliances - Part 1: Ranges, ovens, steam ovens and grills - Methods for measuring performance.

## 14.2 Energy saving



The oven has features which help you save energy during everyday cooking.

Make sure that the oven door is closed when the oven operates. Do not open the oven door too often during cooking. Keep the door gasket clean and make sure it is well fixed in its position.

Use metal cookware to improve energy saving.

When possible, do not preheat the oven before cooking.

Keep breaks between baking as short as possible when you prepare a few dishes at one time.

**Cooking with fan**

When possible, use the cooking functions with fan to save energy.

**Residual heat**

If a programme with the Duration or End Time selection is activated and the cooking time is longer than 30 min, the heating elements automatically turn off earlier in some oven functions. The fan and lamp continue to operate. When you turn off the oven, the display shows the residual heat. You can use that heat to keep the food warm.

When the cooking duration is longer than 30 min, reduce the oven temperature to minimum 3 - 10 min before the end of cooking. The residual heat inside the oven will continue to cook.

Use the residual heat to warm up other dishes.

**Keep food warm**

Choose the lowest possible temperature setting to use residual heat and keep a meal warm.

The residual heat indicator or temperature appears on the display.

**Cooking with the lamp off**

Turn off the lamp during cooking. Turn it on only when you need it.

**Moist Fan Baking**

Function designed to save energy during cooking.

When you use this function the lamp automatically turns off after 30 sec. You may turn on the lamp again but this action will reduce the expected energy savings.

# 15. MENU STRUCTURE

---

## 15.1 Menu

Select: Menu and press the knob.

Menu item		Application
Favourites		Lists the favourite settings.
Assisted cooking		Lists automatic programmes.
Cleaning		Lists cleaning programmes.
Options		To set the oven configuration.
Settings	Setup	To set the oven configuration.
	Service	Shows the software version and configuration.

## 15.2 Submenu for: Cleaning

Submenu	Application
Tank emptying	Procedure for removing the residual water from the water drawer after use of the steam functions.
Descaling	Procedure for cleaning the steam generation circuit from residual limestone.
Rinsing	Procedure for rinsing and cleaning the steam generation circuit after frequent use of the steam functions.
Quick	Duration: 1 h.
Normal	Duration: 1 h 30 min.
Intense	Duration: 3 h.
Cleaning Reminder	Reminds you when to clean the oven.



## 15.3 Submenu for: Options

Submenu	Application
Light	Turns the lamp on and off.
Lamp icon visible	Lamp icon appears on the screen.
Child lock	Prevents accidental activation of the oven. When the option is on, the text "Child Lock" appears on the display when you turn on the oven. To enable the oven use, choose the code letters in the alphabetical order. When the Child Lock is on and the oven is turned off the oven door are locked.
Fast heat up	Shortens heat up time. It is available only for some of the oven functions.

## 15.4 Submenu for: Setup

Submenu	Description
Language	Sets the oven language.
Time of day	Sets the current time and date.
Time indication	Turns the clock on and off.
Digital clock style	Changes the format of the displayed time indication.
Cleaning Reminder	Turns the reminder on and off.
Key tones	Turns the tone of the touch fields on and off. It is not possible to mute the tones for: ①, STOP .
Alarm / Error tones	Turns the alarm tones on and off.
Buzzer volume	Sets the volume of key tones and signals.
Display brightness	Sets the display brightness.
Water hardness	Sets the water hardness.

# MENU STRUCTURE

---

## 15.5 Submenu for: Service





Submenu	Description
Demo mode	Activation / deactivation code: 2468
Licence	Information about licenses.
Software version	Information about software version.
Reset all settings	Restores factory settings.
Reset all popups	Restores all pop-ups to the original settings.

# 16. IT'S EASY!



## Before the first use you have to set:

Language	Display brightness	Buzzer volume	Water hardness	Time of day
----------	--------------------	---------------	----------------	-------------



## Familiarize yourself with the basic icons on the control panel and the display:

 On / Off	 Information	 Timer options	 Food sensor	START / STOP
---	--	--	--	-----------------

## Start using the oven

<b>Quick start</b>	Turn on the oven and start cooking with the default temperature and time of the function.	<b>Step 1</b>	<b>Step 2</b>	<b>Step 3</b>
		Press and hold: 	 ... - press the oven function and then press the knob.	Press: START .
<b>Quick Off</b>	Turn off the oven at any time, any screen or message.	 - press and hold until the oven turns off.		



## Start cooking

<b>Step 1</b>	<b>Step 2</b>	<b>Step 3</b>	<b>Step 4</b>
 - press to turn on the oven.	 ... - select the heating function and press the knob.	 - turn the knob to set the temperature and press.	START - press to start cooking.

## Get to know how to cook quickly

### Use the automatic programmes to prepare a dish quickly with the default settings:

<b>Step 1</b>	<b>Step 2</b>	<b>Step 3</b>	<b>Step 4</b>	<b>Step 5</b>
Press: 	Select: Menu. Press the knob.	Select: Assisted cooking . Press the knob.	Choose the food category.	Choose the dish and press the knob.

Use quick functions to set the cooking time or change the cooking function		
<b>Quick timer settings</b> Use the most used timer settings by choosing from the shortcuts.	<b>Step 1</b>	<b>Step 2</b>
	Select: Timer . Press the knob.	Select preferred timer value and press the knob.
<b>10% Finish assist</b> Use 10% Finish assist to add extra time or change cooking function when 10% of the cooking time is left.	+1 min   +5 min   +10 min - press the preferred time icon to extend the cooking time.	
	Change function: Select preferred function    ... - select preferred function. Press the knob.	

Clean the oven with Steam cleaning		
<b>Step 1</b> Select: Menu. Press the knob.	<b>Step 2</b> Select: Cleaning. Press the knob.	<b>Step 3</b> Choose the mode:
<b>Descaling</b>	For cleaning the steam generation circuit from residual limestone.	
<b>Rinsing</b>	For rinsing and cleaning the steam generation circuit after frequent use of the steam functions.	

## 17. TAKE A SHORTCUT!

---

Here you can see all the useful shortcuts. You can also find them in the dedicated chapters in the user manual.

### How to set: Heating functions



### How to set: Cooking with a steam heating function



### How to set: Assisted cooking



### How to set: Cooking time



### How to delay: Start and end of cooking



### How to cancel: Set Timer



### How to use: Food Sensor



# 18. WARRANTY

---

FOR SALES IN AUSTRALIA AND NEW ZEALAND

ALL AEG BRANDED APPLIANCES

**This document sets out the terms and conditions of the product warranties for AEG Appliances. It is an important document. Please keep it with your proof of purchase documents in a safe place for future reference should there be a manufacturing defect in your Appliance. This warranty is in addition to other rights you may have under the Australian Consumer Law.**

**1. In this warranty:**

- a) 'ACL' or 'Australian Consumer Law' means Schedule 2 to the Competition and Consumer Act 2010;
- b) 'Appliance' means any Electrolux product purchased by you and accompanied by this document;
- c) 'ASC' means Electrolux's authorised serviced centres;
- d) 'AEG' is the brand controlled by Electrolux Home Products Pty Ltd of 163 O'Riordan Street, Mascot NSW 2020, ABN 51 004 762 341 in respect of Appliances purchased in Australia and Electrolux (NZ) Limited (collectively "Electrolux") of 3-5 Niall Burgess Road, Mount Wellington, in respect of Appliances purchased in New Zealand;
- e) 'Warranty Period' means the period specified in clause 3 of this warranty;
- f) 'you' means the purchaser of the Appliance not having purchased the Appliance for resale, and 'your' has a corresponding meaning.

2. **Application:** This warranty only applies to new Appliances, purchased and used in Australia or New Zealand and is in addition to (and does not exclude, restrict, or modify in any way) other rights and remedies under a law to which the Appliances or services relate, including any non-excludable statutory guarantees in Australia and New Zealand.
3. **Warranty Period:** Subject to these terms and conditions, this warranty continues for in Australia for a period of 60 months and in New Zealand for a period of 60 months, following the date of original purchase of the Appliance.
4. **Repair or replace warranty:** During the Warranty Period, Electrolux or its ASC will, at no extra charge if your Appliance is readily accessible for service, without special equipment and subject to these terms and conditions, repair or replace any parts which it considers to be defective. Electrolux may, in its absolute discretion, choose whether the remedy offered for a valid warranty claim is repair or replacement. Electrolux or its ASC may use refurbished parts to repair your Appliance. You agree that any replaced Appliances or parts become the property of Electrolux.
5. **Travel and transportation costs:** Subject to clause 7, Electrolux will bear the reasonable cost of transportation, travel and delivery of the Appliance to and from Electrolux or its ASC. Travel and transportation will be arranged by Electrolux as part of any valid warranty claim.
6. **Proof of purchase** is required before you can make a claim under this warranty.
7. **Exclusions:** You may not make a claim under this warranty unless the defect claimed is due to faulty or defective parts or workmanship. This warranty does not cover:
  - a) light globes, batteries, filters or similar perishable parts;
  - b) parts and Appliances not supplied by Electrolux;
  - c) cosmetic damage which does not affect the operation of the Appliance;
  - d) damage to the Appliance caused by:
    - negligence or accident;
    - misuse or abuse, including failure to properly maintain or service;
    - improper, negligent or faulty servicing or repair works done by anyone other than an Electrolux authorised repairer or ASC;
    - normal wear and tear;
    - power surges, electrical storm damage or incorrect power supply;
    - incomplete or improper installation;
    - incorrect, improper or inappropriate operation;
    - insect or vermin infestation;

– failure to comply with any additional instructions supplied with the Appliance;

In addition, Electrolux is not liable under this warranty if:

- the Appliance has been, or Electrolux reasonably believes that the Appliance has been, used for purposes other than those for which the Appliance was intended, including where the Appliance has been used for any non-domestic purpose;
- the Appliance is modified without authority from Electrolux in writing;
- the Appliance's serial number or warranty seal has been removed or defaced.

**8. How to claim under this warranty:** To enquire about claiming under this warranty, please follow these steps:

- a. carefully check the operating instructions, user manual and the terms of this warranty;
- b. have the model and serial number of the Appliance available;
- c. have the proof of purchase (e.g. an invoice) available;
- d. telephone the numbers shown below.

**9. Australia:** For Appliances and services provided by Electrolux in Australia: Electrolux goods come with guarantees that cannot be excluded under the Australian Consumer Law. You are entitled to a replacement or refund for a major failure and for compensation for any other reasonably foreseeable loss or damage. You are also entitled to have the Appliance repaired or replaced if the Appliance fails to be of acceptable quality and the failure does not amount to a major failure. 'Acceptable quality' and 'major failure' have the same meaning as referred to in the ACL.

**10. New Zealand:** For Appliances and services provided by Electrolux in New Zealand, the Appliances come with a guarantee by Electrolux pursuant to the provisions of the Consumer Guarantees Act, the Sale of Goods Act and the Fair Trading Act. Where the Appliance was purchased in New Zealand for commercial purposes the Consumer Guarantee Act does not apply.

**11. Confidentiality:** You accept that if you make a warranty claim, Electrolux and its agents including ASC may exchange information in relation to you to enable Electrolux to meet its obligations under this warranty.

### Important Notice

Before calling for service, please ensure that the steps listed in clause 8 above have been followed.

### SERVICE AUSTRALIA

[aeg.com/au](http://aeg.com/au)

#### FOR SERVICE

or to find the address of your nearest authorised service centre in Australia

**PLEASE CALL 1300 363 664**

**OR EMAIL**

**[customercare@aegaustralia.com.au](mailto:customercare@aegaustralia.com.au)**

For the cost of a local call (Australia only)

#### FOR SPARE PARTS

or to find the address of your nearest spare parts centre in Australia

**PLEASE CALL 13 13 50**

**OR EMAIL**

**[customercare@aegaustralia.com.au](mailto:customercare@aegaustralia.com.au)**

For the cost of a local call (Australia only)

### SERVICE NEW ZEALAND

[aegnewzealand.co.nz](http://aegnewzealand.co.nz)

**FOR SERVICE**

or to find the address of your nearest authorised service centre in New Zealand

**PLEASE CALL 0800 234 234**

**OR EMAIL**

**customercare@electrolux.co.nz**

(New Zealand only)

**FOR SPARE PARTS**

or to find the address of your nearest spare parts centre in New Zealand

**PLEASE CALL 0800 10 66 20**

**OR EMAIL**

**customercare@electrolux.co.nz**



(New Zealand only)

AEG\_Warr\_May\_17



## 19. ENVIRONMENTAL CONCERNS

---

Recycle materials with the symbol . Put the packaging in relevant containers to recycle it. Help protect the environment and human health by recycling waste of electrical and electronic appliances. Do not dispose of appliances marked with the symbol  with the household waste. Return the product to your local recycling facility or contact your municipal office.





