

# USER MANUAL



## CONTENTS

1. SAFETY INFORMATION.....	3
2. SAFETY INSTRUCTIONS.....	4
3. PRODUCT DESCRIPTION.....	6
4. CONTROL PANEL.....	7
5. PROGRAMME SELECTION.....	8
6. BASIC SETTINGS .....	10
7. BEFORE FIRST USE.....	13
8. DAILY USE.....	13
9. HINTS AND TIPS.....	16
10. CARE AND CLEANING.....	17
11. TROUBLESHOOTING.....	21
12. TECHNICAL INFORMATION.....	24
13. INSTALLATION.....	25
14. WARRANTY .....	26
15. ENVIRONMENTAL CONCERNS.....	29

## IMPORTANT INFORMATION THAT MAY IMPACT YOUR MANUFACTURER'S WARRANTY

Adherence to the directions for use in this manual is extremely important for health and safety. Failure to strictly adhere to the requirements in this manual may result in personal injury, property damage and affect your ability to make a claim under the AEG manufacturer's warranty provided with your product. Products must be used, installed and operated in accordance with this manual. You may not be able to claim on the AEG manufacturer's warranty in the event that your product fault is due to failure to adhere to this manual.

## FOR PERFECT RESULTS

Thank you for choosing this AEG product. We have created it to give you impeccable performance for many years, with innovative technologies that help make life simpler features you might not find on ordinary appliances. Please spend a few minutes reading to get the very best from it.

Visit our website for:



Get usage advice, brochures, trouble shooter, service information:

**[www.aeg.com](http://www.aeg.com)**



Register your product for better service:

**[www.registeraeg.com](http://www.registeraeg.com)**

## CUSTOMER CARE AND SERVICE

Always use original spare parts.

When contacting our Authorised Service Centre, ensure that you have the following data available: Model, PNC, Serial Number.

The information can be found on the rating plate.

 Warning / Caution-Safety information

 General information and tips



Subject to change without notice.

## 1. SAFETY INFORMATION

Before the installation and use of the appliance, carefully read the supplied instructions. The manufacturer is not responsible for any injuries or damage that are the result of incorrect installation or usage. Always keep the instructions in a safe and accessible location for future reference.

### 1.1 Children and vulnerable people safety

- This appliance can be used by children aged from 8 years and above and persons with reduced physical, sensory or mental capabilities or lack of experience and knowledge if they have been given supervision or instruction concerning the use of the appliance in a safe way and understand the hazards involved.
- Children between 3 and 8 years of age and persons with very extensive and complex disabilities shall be kept away from the appliance unless continuously supervised.
- Children of less than 3 years of age should be kept away from the appliance unless continuously supervised.
- Children should be supervised to ensure that they do not play with the appliance.
- Keep detergents away from children.
- Keep children and pets away from the appliance when the door is open.
- Children shall not carry out cleaning and user maintenance of the appliance without supervision.

### 1.2 General Safety

- This appliance is intended to be used in household and similar applications such as:

- farm houses; staff kitchen areas in shops, offices and other working environments;
- by clients in hotels, motels, bed & breakfast and other residential type environments.
- Do not change the specification of this appliance.
- The operating water pressure (minimum and maximum) must be between 0.5 (5) / 10 (1000) bar (kPa)
- Obey the maximum number of 14 place settings.
- If the supply cord is damaged, it must be replaced by the manufacturer, its Authorised Service Centre or a similarly qualified persons in order to avoid a hazard.
- Put knives and cutlery with sharp points in the cutlery basket with the points down or in a horizontal position.
- Do not leave the appliance with the door open, to avoid a tripping hazard.
- Before any maintenance operation, deactivate the appliance and disconnect the mains plug from the socket.
- Do not use high pressure water sprays and/or steam to clean the appliance.
- The appliance is to be connected to the water mains using the new supplied hose-sets. Old hose sets must not be reused.
- The ventilation openings in the base (if applicable) must not be obstructed by a carpet.
- Some dishwasher detergents are strongly alkaline. They can be extremely dangerous if swallowed. Avoid contact with the skin and eyes and keep children away from the dishwasher when the door is open.
- Check that the detergent receptacle is empty after completion of the wash cycle.

## 2. SAFETY INSTRUCTIONS

### 2.1 Installation



**WARNING!**  
Only a qualified person must install this appliance.

- Remove all the packaging.
- Do not install or use a damaged appliance.

- Do not use the appliance before installing it in the built-in structure due to safety manner.
- Follow the installation instructions supplied with the appliance.
- Always take care when moving the appliance as it is heavy. Always use safety gloves and enclosed footwear.
- Do not install or use the appliance where the temperature is less than 0 °C.
- Install the appliance in a safe and suitable place that meets installation requirements.



[www.youtube.com/electrolux](http://www.youtube.com/electrolux)  
[www.youtube.com/aeg](http://www.youtube.com/aeg)

How to install your 60 cm  
Dishwasher Sliding Hinge



## 2.2 Electrical connection



### WARNING!

Risk of fire and electric shock.

- The appliance must be earthed.
- Make sure that the parameters on the rating plate are compatible with the electrical ratings of the mains power supply.
- Always use a correctly installed shockproof socket.
- Do not use multi-plug adapters and extension cables.
- Make sure not to cause damage to the mains plug and to the mains cable. Should the mains cable need to be replaced, this must be carried out by our Authorised Service Centre.
- Connect the mains plug to the mains socket only at the end of the installation. Make sure that there is access to the mains plug after the installation.
- Do not pull the mains cable to disconnect the appliance. Always pull the mains plug.

## 2.3 Water connection

- Do not cause damage to the water hoses.
- Before connection to new pipes, pipes not used for a long time, where repair

work has been carried out or new devices fitted (water meters, etc.), let the water flow until it is clean and clear.

- Ensure that there are no visible water leaks during and after the first use of the appliance.
- The water inlet hose has a safety valve and a sheath with an inner mains cable.

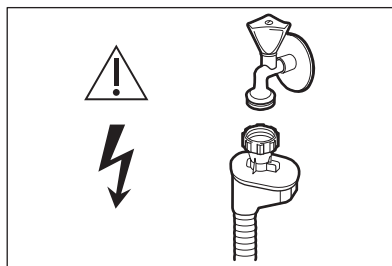

### WARNING!

Dangerous voltage.

- If the water inlet hose is damaged, immediately close the water tap and disconnect the mains plug from the mains socket. Contact the Authorised Service Centre to replace the water inlet hose.

## 2.4 Use

- Do not put flammable products or items that are wet with flammable products in, near or on the appliance.
- Dishwasher detergents are dangerous. Follow the safety instructions on the detergent packaging.
- Do not drink and play with the water in the appliance.
- Do not remove the dishes from the appliance until the programme is complete. Some detergent may remain on the dishes.
- Do not store items or apply pressure on the open door of the appliance.
- The appliance can release hot steam if you open the door while a programme operates.

## 2.5 Internal lighting



### WARNING!

Risk of injury.

- This appliance has an internal lamp that comes on when you open the door and goes off when the door is closed.
- To replace the internal lighting, contact the Authorised Service Centre.

## 2.6 Service

- To repair the appliance contact the Authorised Service Centre. Use original spare parts only.
- Please note that self-repair or non-professional repair can have safety consequences and might void the guarantee.
- Concerning the lamp(s) inside this product and spare part lamps sold separately: These lamps are intended to withstand extreme physical

conditions in household appliances, such as temperature, vibration, humidity, or are intended to signal information about the operational status of the appliance. They are not intended to be used in other applications and are not suitable for household room illumination.

## 2.7 Disposal



### WARNING!

Risk of injury or suffocation.

- Disconnect the appliance from the mains supply.
- Cut off the mains cable and discard it.
- Remove the door catch to prevent children and pets to get closed in the appliance.

## 3. PRODUCT DESCRIPTION

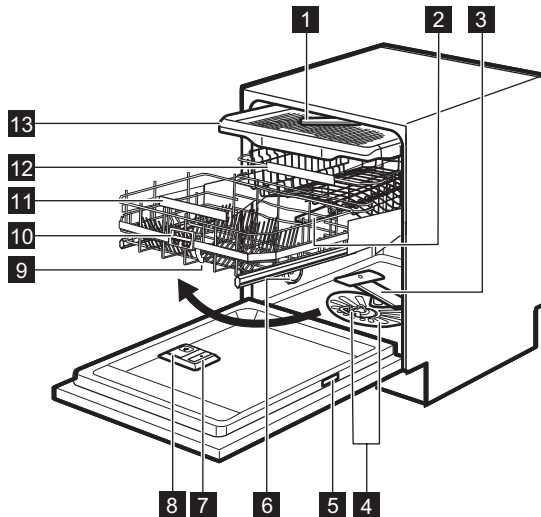

- 1** Ceiling spray arm
- 2** Upper spray arm
- 3** Lower spray arm
- 4** Filters
- 5** Rating plate
- 6** Air vent

- 7** Rinse aid dispenser
- 8** Detergent dispenser
- 9** Comfort Lift basket
- 10** Release handle
- 11** Lower basket handle
- 12** Upper basket

### 13 Cutlery drawer

## 3.1 Internal light

The appliance has an internal lamp. It comes on when you open the door or switch the appliance on while the door is open.

The lamp goes off when you close the door or switch the appliance off. Otherwise, it goes off automatically after some time to save energy.

## 4. CONTROL PANEL

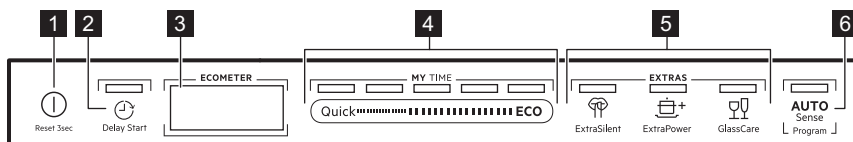

**1** On/Off button / Reset button

**2** Delay Start button

**3** Display

**4** MY TIME selection bar

**5** EXTRAS buttons

**6** AUTO Sense program button

### 4.1 Display

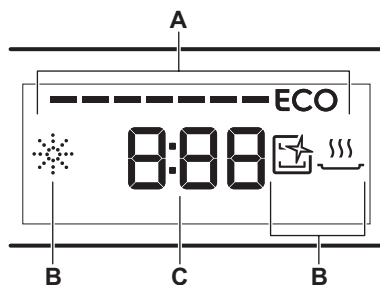

A. ECOMETER

B. Indicators

C. Time indicator

### 4.2 ECOMETER





The ECOMETER indicates how the programme selection impacts energy and water consumption. The more bars are on, the lower the consumption is.

**ECO** indicates the most environmentally friendly programme selection for a normally soiled dishwashing load.

### 4.3 Indicators

Indicator	Description
	Rinse aid indicator. It is on when the rinse aid dispenser needs refilling. Refer to " <b>Before first use</b> ".

Indicator	Description
	Machine Care indicator. It is on when the appliance needs internal cleaning with the Machine Care programme. Refer to " <b>Care and cleaning</b> ".
	Drying phase indicator. It is on when a programme with the drying phase is selected. It flashes when the drying phase operates. Refer to " <b>Programme selection</b> ".

## 5. PROGRAMME SELECTION

### 5.1 MY TIME

Using MY TIME selection bar, you can select a suitable wash cycle based on programme duration.

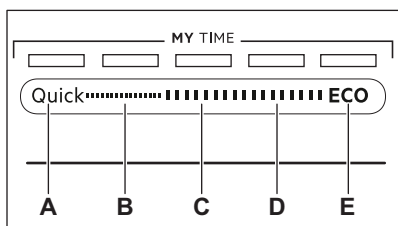

- Quick** is the shortest programme (**30min**) suitable for washing a load with fresh and light soil.
- 1h** is a programme suitable for washing a load with fresh and lightly dried-on soil.
- 1h 30min** is a programme suitable for washing and drying normally soiled items.
- 2h 40min** is a programme suitable for washing and drying heavily soiled items.
- ECO** is the longest programme (**3h**) offering the most efficient use of energy and water consumption for crockery and cutlery with normal soil. This is the standard programme for test institutes.

### 5.2 EXTRAS

You can adjust the programme selection to your needs by activating EXTRAS.

### ExtraSilent

 ExtraSilent allows to reduce the noise generated by the appliance. When the option is activated, the wash pump works quietly at a lower speed. Due to the low speed, the programme duration is longer.

### ExtraPower

 ExtraPower improves the dishwashing results of the selected programme. The option increases the wash temperature and duration.

### GlassCare

 GlassCare prevents delicate load, glassware in particular, from damaging. The option prevents rapid changes in the dishwashing temperature of the selected programme and reduces it to 45 °C.

### 5.3 AUTO Sense

The AUTO Sense programme automatically adjusts the dishwashing cycle to the type of load.

The appliance senses the degree of soil and the amount of dishes in the baskets. It adjusts the temperature and quantity of water as well as the wash duration.



## 5.4 Programmes overview

Programme	Dishwasher load	Degree of soil	Programme phases	EXTRAS
Quick	Crockery, cutlery	Fresh	<ul style="list-style-type: none"> <li>• Dishwashing 50 °C</li> <li>• Intermediate rinse</li> <li>• Final rinse 50 °C</li> <li>• AirDry <sup>1)</sup></li> </ul>	<ul style="list-style-type: none"> <li>• ExtraPower</li> <li>• GlassCare</li> </ul>
1h	Crockery, cutlery	Fresh, lightly dried-on	<ul style="list-style-type: none"> <li>• Dishwashing 60 °C</li> <li>• Intermediate rinse</li> <li>• Final rinse 50 °C</li> <li>• AirDry <sup>1)</sup></li> </ul>	<ul style="list-style-type: none"> <li>• ExtraPower</li> <li>• GlassCare</li> </ul>
1h 30min	Crockery, cutlery, pots, pans	Normal, lightly dried-on	<ul style="list-style-type: none"> <li>• Dishwashing 60 °C</li> <li>• Intermediate rinse</li> <li>• Final rinse 55 °C</li> <li>• Drying</li> <li>• AirDry <sup>1)</sup></li> </ul>	<ul style="list-style-type: none"> <li>• ExtraPower</li> <li>• GlassCare</li> </ul>
2h 40min	Crockery, cutlery, pots, pans	Normal to heavy, dried-on	<ul style="list-style-type: none"> <li>• Prewash</li> <li>• Dishwashing 60 °C</li> <li>• Intermediate rinse</li> <li>• Final rinse 60 °C</li> <li>• Drying</li> <li>• AirDry <sup>1)</sup></li> </ul>	<ul style="list-style-type: none"> <li>• ExtraPower</li> <li>• GlassCare</li> </ul>
ECO	Crockery, cutlery, pots, pans	Normal, lightly dried-on	<ul style="list-style-type: none"> <li>• Prewash</li> <li>• Dishwashing 50 °C</li> <li>• Intermediate rinse</li> <li>• Final rinse 60 °C</li> <li>• Drying</li> <li>• AirDry <sup>1)</sup></li> </ul>	<ul style="list-style-type: none"> <li>• ExtraPower</li> <li>• GlassCare</li> <li>• ExtraSilent</li> </ul>
AUTO Sense	Crockery, cutlery, pots, pans	All	<ul style="list-style-type: none"> <li>• Prewash</li> <li>• Dishwashing 50 - 60 °C</li> <li>• Intermediate rinse</li> <li>• Final rinse 60 °C</li> <li>• Drying</li> <li>• AirDry <sup>1)</sup></li> </ul>	Not applicable
Machine Care	For cleaning the appliance interior. Refer to "Care and Cleaning".		<ul style="list-style-type: none"> <li>• Cleaning 70 °C</li> <li>• Intermediate rinse</li> <li>• Final rinse</li> <li>• AirDry <sup>1)</sup></li> </ul>	Not applicable

<sup>1)</sup> Automatic door opening during the drying phase. Refer to "Basic settings".

## Consumption values

Programme 1) 2)	Water (l)	Energy (kWh)	Duration (min)
Quick	10.4	0.61	30
1h	12.6	0.92	60
1h 30min	13.1	1.07	90
2h 40min	12.5	1.13	160
ECO	11.2	0.742	180
AUTO Sense	12.5	1.15	170
Machine Care	11.4	0.87	60

1) The pressure and the temperature of the water, the variations of the mains supply, the options, the quantity of dishes and the degree of soil can change the values.

2) The values for programmes other than ECO are indicative only.

### Information for test institutes

To receive the necessary information for conducting performance tests (e.g. according to: EN60436 ), send an email to:

[info.test@dishwasher-production.com](mailto:info.test@dishwasher-production.com)

In your request, include the product number code (PNC) from the rating plate.

For any other questions regarding your dishwasher, refer to the service book provided with your appliance.

## 6. BASIC SETTINGS

You can configure the appliance by changing basic settings according to your needs.

No	Settings	Values	Description <sup>1)</sup>
1	Rinse aid level	From level 0A to level 6A (default: 4A)	Adjust the level of the rinse aid according to the necessary dosage.
2	End sound	On Off (default)	Activate or deactivate the acoustic signal for the end of a programme.
3	Auto door open	On (default) Off	Activate or deactivate the AirDry.
4	Key tones	On (default) Off	Activate or deactivate the sound of the buttons when pressed.
5	Latest programme selection	On Off (default)	Enable or disable the automatic selection of the most recently used programme and options.

No	Settings	Values	Description <sup>1)</sup>
6	Display on floor	On (default) Off	Activate or deactivate the TimeBeam.

<sup>1)</sup> For more details, refer to the information provided in this chapter.

You can change the basic settings in setting mode.

When the appliance is in setting mode, the bars of the ECOMETER represent available settings. For each setting, a dedicated bar of the ECOMETER flashes.

The order of the basic settings presented in the table is also the order of the settings on the ECOMETER:

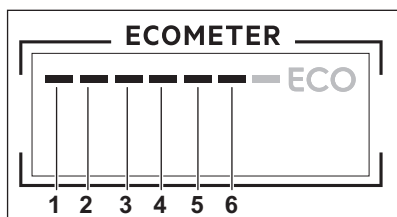

## 6.1 Setting mode

### How to navigate in setting mode

You can navigate in setting mode using MY TIME selection bar.

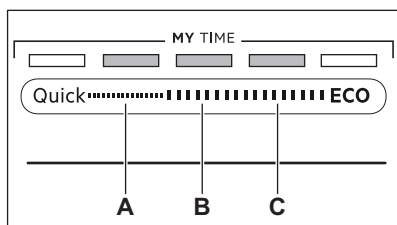

- A. **Previous** button
- B. **OK** button
- C. **Next** button

Use **Previous** and **Next** to switch between the basic settings and to change their value.

Use **OK** to enter the selected setting and to confirm changing its value.

### How to enter setting mode

You can enter setting mode before starting a programme. You cannot enter setting mode while the programme is running.

To enter setting mode, press and hold simultaneously **Quick** and **ECO** for about 3 seconds. The lights related to the **Previous**, **OK** and **Next** are on.

### How to change a setting

Make sure the appliance is in setting mode.

1. Use **Previous** or **Next** to select the bar of the ECOMETER dedicated to the desired setting.
  - The bar of the ECOMETER dedicated to the chosen setting flashes.
  - The display shows the current setting value.
2. Press **OK** to enter the setting.
  - The bar of the ECOMETER dedicated to the chosen setting is on. The other bars are off.
  - The current setting value flashes.
3. Press **Previous** or **Next** to change the value.
4. Press **OK** to confirm the setting.
  - The new setting is saved.
  - The appliance returns to the basic settings list.
5. Press and hold simultaneously **Quick** and **ECO** for about 3 seconds to exit setting mode.

The appliance returns to the programme selection.

The saved settings remain valid until you change them again.

## 6.2 The rinse aid level

The rinse aid helps to dry the dishes without streaks and stains. It is

automatically released during the hot rinse phase. It is possible to set the released quantity of rinse aid.

When rinse aid chamber is empty, the rinse aid indicator is on notifying to refill rinse aid. If the drying results are satisfactory while using multi-tablets only, it is possible to deactivate the dispenser and the indicator. However, for best drying performance, always use rinse aid and keep the rinse aid indicator active.

To deactivate the rinse aid dispenser and indicator, set the level of rinse aid to 0A.

### 6.3 End sound

You can activate an acoustic signal that sounds when the programme is completed.

 Acoustic signals sound also when a malfunction of the appliance occurs. It is not possible to deactivate these signals.

### 6.4 AirDry

AirDry improves the drying results. The appliance door opens automatically during the drying phase and remains ajar.

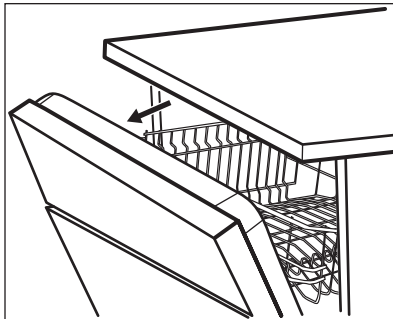

AirDry is automatically activated with all programmes.

The duration of the drying phase and the door opening time vary depending on the selected programme and options.

When AirDry opens the door, the display shows the remaining time of the running programme.



#### CAUTION!

Do not try to close the appliance door within 2 minutes after automatic opening. This can cause damage to the appliance.



#### CAUTION!

If children have access to the appliance, we advise to deactivate AirDry. The automatic opening of the door may pose a danger.

### 6.5 Key tones

The buttons on the control panel make a click sound when you press them. You can deactivate this sound.

### 6.6 Latest programme selection

You can set the automatic selection of the most recently used programme and options.

The latest programme that was completed before the appliance deactivation is saved. It is then selected automatically after you activate the appliance.

When the latest programme selection is disabled, the default programme is ECO.

### 6.7 TimeBeam

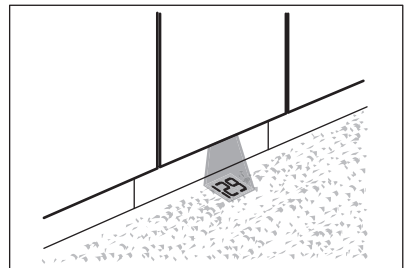

TimeBeam displays the following information on the floor below the appliance door:

- The programme duration when the programme begins.
- **0:00** and **CLEAN** when the programme is completed.

- **DELAY** and the countdown duration when the delay start begins.
- An alarm code when the appliance has a malfunction.



When AirDry opens the door, TimeBeam is off. To check the remaining time of the running programme, look at the control panel display.

## 7. BEFORE FIRST USE

1. Fill the rinse aid dispenser.
2. Open the water tap.
3. Start the Quick programme to remove any residuals from the manufacturing process. Do not use detergent and do not put dishes in the baskets.

### 7.1 How to fill the rinse aid dispenser

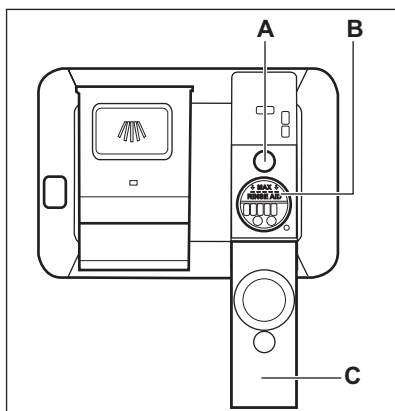

#### CAUTION!

The compartment (B) is for rinse aid only. Do not fill it with detergent.



#### CAUTION!

Only use rinse aid designed specifically for dishwashers.

1. Open the lid (C).
2. Fill the dispenser (B) until the rinse aid reaches the marking "MAX".
3. Remove the spilled rinse aid with an absorbent cloth to prevent excessive foam formation.
4. Close the lid. Make sure that the lid locks into position.



Fill the rinse aid dispenser when the indicator (A) is clear.

## 8. DAILY USE

1. Open the water tap.
2. Press and hold  until the appliance is activated.
3. Fill the rinse aid dispenser if it is empty.
4. Load the baskets.
5. Add the detergent.
6. Select and start a programme.
7. Close the water tap when the programme is complete.

### 8.1 ComfortLift



#### CAUTION!

Do not sit on the rack or put excessive pressure on the locked basket.



#### CAUTION!

Do not exceed the max load capacity of 18 kg.

**CAUTION!**

Make sure that items do not stick out of the basket frame as it can cause damage to the items and the ComfortLift mechanism.

The ComfortLift mechanism allows to lift the lower rack up (to the second rack level) and put it down to load and unload dishes easily.

To load or unload the lower basket:

1. Lift the basket by pulling the rack out of the dishwasher by the basket handle. The release handle should not be used.

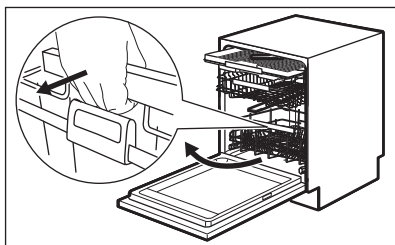

The basket is automatically locked on the upper level.

2. Carefully place items in the basket or remove them (refer to **Basket loading leaflet**).
3. Lower the basket by connecting the release handle with the basket frame as shown below. Lift the release handle completely and the basket handle slightly until the basket is disengaged on both sides.

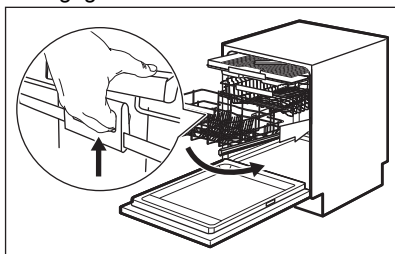

Once the basket is unlocked, push the rack down. The mechanism returns to its default position on the lower level.

There are two ways of lowering the basket depending on the loading:

- If there is a full load of plates, slightly push the basket down.
- If the basket is empty or half-loaded, press the basket down.

## 8.2 Using the detergent

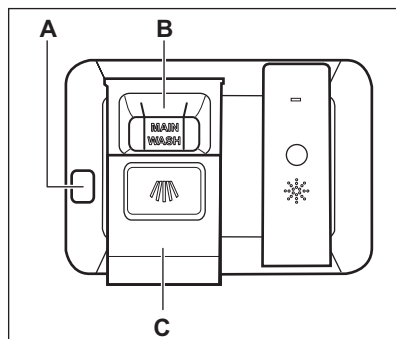
**CAUTION!**

Only use detergent specifically designed for dishwashers.

1. Press the release button (A) to open the lid (C).
2. Put the detergent (gel, powder or tablets) in the compartment (B).
3. If the programme has a prewash phase, put a small quantity of detergent on the inner part of the appliance door.
4. Close the lid. Make sure that the lid locks into position.



For information about the detergent dosage, refer to the manufacturer's instructions on the packaging of the product. Usually, 20 - 25 ml of gel detergent is adequate for washing a load with normal soil.



The upper ends of the two vertical ribs inside the compartment (B) indicate the maximum level for filling the dispenser with gel (max. 30ml).

### 8.3 How to select and start a programme using MY TIME selection bar

- Slide your finger across MY TIME selection bar to choose a suitable programme.
  - The light related to the selected programme is on.
  - The ECOMETER indicates the level of energy and water consumption.
  - The display shows the programme duration.
- Activate applicable EXTRAS if desired.
- Close the appliance door to start the programme.

### 8.4 How to activate EXTRAS

- Select a programme using MY TIME selection bar.
- Press the button dedicated to the option you want to activate.
  - The light related to the button is on.
  - The display shows the updated programme duration.
  - The ECOMETER indicates the updated level of energy and water consumption.



By default, options must be activated every time before you start a programme. If the latest programme selection is enabled, the saved options are activated automatically along with the programme.



It is not possible to activate or deactivate options while a programme is running.



Not all options are compatible with each other.



Activating options often increases the water and energy consumption as well as the programme duration.

### 8.5 How to start the AUTO Sense program

- Press **AUTO**<sub>Sense</sub>.
  - The light related to the button is on.
  - The display shows the longest possible program duration.
- Close the appliance door to start the program.

The appliance senses the type of load and adjusts a suitable wash cycle. During the cycle, the sensors operate several times and the initial program duration can decrease.

### 8.6 How to delay the start of a programme

- Select a programme.
- Press repeatedly until the display shows the desired delay time (from 1 to 24 hours).  
The light related to the button is on.
- Close the appliance door to start the countdown.

During the countdown, it is not possible to change the delay time and the programme selection.

When the countdown is complete, the programme starts.

### 8.7 How to cancel the delay start while the countdown operates

Press and hold for about 3 seconds. The appliance returns to the programme selection.



If you cancel the delay start, you have to select the programme again.

### 8.8 How to cancel a running programme

Press and hold for about 3 seconds. The appliance returns to the programme selection.



Make sure that there is detergent in the detergent dispenser before you start a new programme.

## 8.9 Opening the door while the appliance operates

Opening the door while a programme is running stops the appliance. It may affect the energy consumption and the programme duration. After closing the door, the appliance continues from the point of interruption.



If the door is opened for more than 30 seconds during the drying phase, the running programme ends. It does not happen if the door is opened by AirDry function.

## 8.10 The Auto Off function

This function saves energy by switching the appliance off when it is not operating.

The function comes into operation automatically:

- When the programme is completed.
- After 5 minutes if a programme was not started.

## 8.11 End of the programme

When the programme is complete, the display shows **0:00**.

The Auto Off function switches the appliance off automatically.

All buttons are inactive except for the on/off button.

# 9. HINTS AND TIPS

## 9.1 General

Follow the hints below to ensure optimal cleaning and drying results in daily use and to help you protect the environment.

- Remove larger residues of food from the dishes into the waste bin.
- Do not pre-rinse dishes by hand. When needed, select a programme with a prewash phase.
- Always use the whole space of the baskets.
- Make sure that items in the baskets do not touch or cover each other. Only then can the water completely reach and wash the dishes.
- You can use dishwasher detergent and rinse aid separately or you can use the multi-tablets. Follow the instructions on the packaging.
- Select a programme according to the type of load and the degree of soil. ECO offers the most efficient use of water and energy consumption for crockery and cutlery with normal soil.

## 9.2 Using rinse aid and detergent

- Only use rinse aid and detergent designed for dishwasher. Other

products can cause damage to the appliance.

- Detergent tablets do not fully dissolve with short programmes. To prevent detergent residues on the tableware, we recommend that you use the tablets with long programmes.
- Do not use more than the correct quantity of detergent. Refer to the instructions on the detergent packaging.

## 9.3 Loading the baskets

- Always use the whole space of the baskets.
- Use the appliance to wash dishwasher-safe items only.
- Do not wash in the appliance items made of wood, horn, aluminium, pewter and copper as they could crack, warp, get discoloured or pitted.
- Do not wash in the appliance items that can absorb water (sponges, household cloths).
- Put hollow items (cups, glasses and pans) with the opening facing downwards.
- Make sure that glass items do not touch each other.



- Put light items in the upper basket. Make sure that the items do not move freely.
- Put cutlery and small items in the cutlery drawer.
- Move the upper basket upwards to accommodate large items in the lower basket.
- Make sure that the spray arms can move freely before you start a programme.

## 9.4 Before starting a programme

Make sure that:

- The filters are clean and correctly installed.
- The spray arms are not clogged.
- There is dishwasher rinse aid (unless you use multi-tablets).
- The position of the items in the baskets is correct.

- The programme is applicable to the type of load and for the degree of soil.
- The correct quantity of detergent is used.

## 9.5 Unloading the baskets

1. If AirDry is deactivated, open the door by approximately 10cm at the end of the programme.
2. Let the tableware cool down for 30 - 40 minutes before removing it from the appliance. Hot items can be easily damaged.
3. First remove items from the lower basket, then from the upper basket.



At the end of the programme, water can still remain on the inside surfaces of the appliance.

# 10. CARE AND CLEANING



### WARNING!

Before any maintenance other than running the programme Machine Care, deactivate the appliance and disconnect the mains plug from the main socket.



Make sure that the ComfortLift basket is empty and locked in the raised position.



Dirty filters and clogged spray arms negatively affect the washing results. Check these elements regularly and, if necessary, clean them.

## 10.1 Machine Care

Machine Care is a programme designed to clean the appliance interior with optimal results. It removes limescale and grease buildup.



When the appliance senses the need for cleaning, the indicator  is on. Start the Machine Care programme to clean the appliance interior.

## How to start the Machine Care programme



Before starting the Machine Care programme, clean the filters and spray arms.

1. Use a descaler or a cleaning product designed specifically for dishwashers. Follow the instructions on the packaging. Do not put dishes in the baskets.
2. Press and hold simultaneously  and **AUTO**<sub>Sense</sub> for about 3 seconds.

The indicators  and  flash. The display shows the programme duration.

3. Close the appliance door to start the programme.

When the programme is complete, the indicator  is off.

## 10.2 Internal cleaning

- Clean the appliance interior with a soft damp cloth.
- Do not use abrasive products, abrasive cleaning pads, sharp tools, strong chemicals, scourer or solvents.
- Wipe clean the door, including the rubber gasket, once a week.
- To maintain the performance of your appliance, use a cleaning product designed specifically for dishwashers at least once every two months. Carefully follow the instructions on the packaging of the product.
- For optimal cleaning results, start the programme Machine Care.

## 10.3 External cleaning

- Clean the appliance with a moist soft cloth.
- Only use neutral detergents.
- Do not use abrasive products, abrasive cleaning pads or solvents.

## 10.4 Cleaning the filters

The filter system is made of 3 parts.

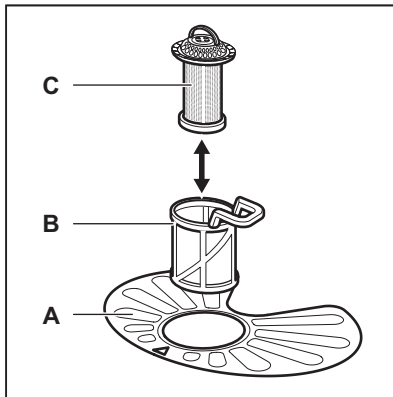

1. Turn the filter (B) counterclockwise and remove it.

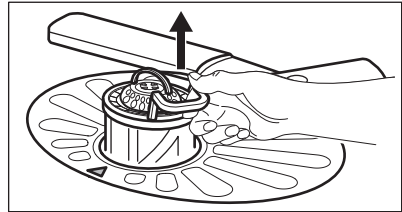
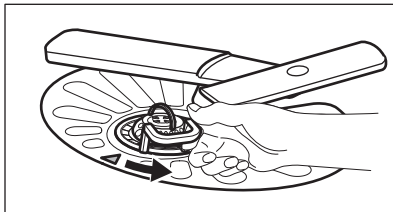

2. Remove the filter (C) out of filter (B).
3. Remove the flat filter (A).

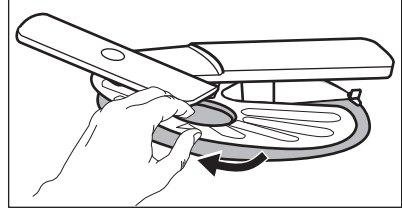

4. Wash the filters.

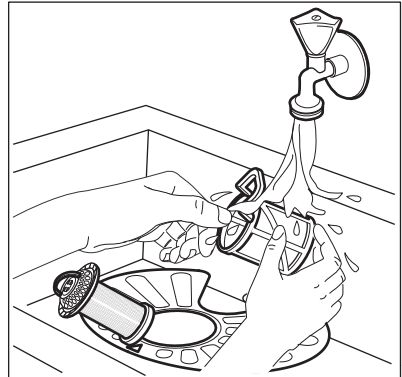

5. Make sure that there are no residues of food or soil in or around the edge of the sump.
6. Put back in place the flat filter (A). Make sure that it is correctly positioned under the 2 guides.

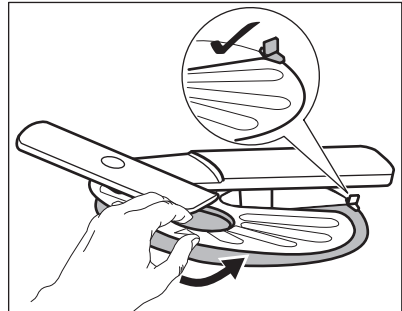

7. Reassemble the filters (B) and (C).

8. Put back the filter (B) in the flat filter (A). Turn it clockwise until it locks.

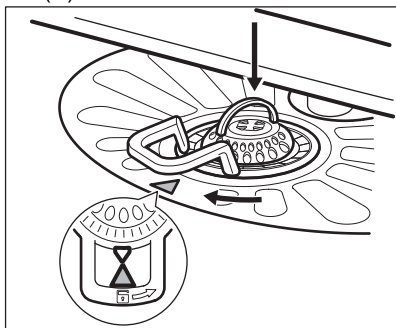

**CAUTION!**

An incorrect position of the filters can cause bad washing results and damage to the appliance.

### 10.5 Cleaning the lower spray arm

We recommend to clean the lower spray arm regularly to prevent soil from clogging the holes.

Clogged holes can cause unsatisfactory washing results.

1. To remove the lower spray arm, pull it upwards.

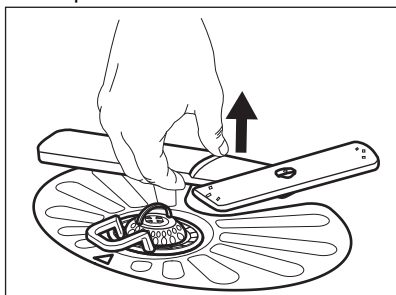

2. Wash the spray arm under running water. Use a thin pointed tool, e.g. a toothpick, to remove particles of soil from the holes.

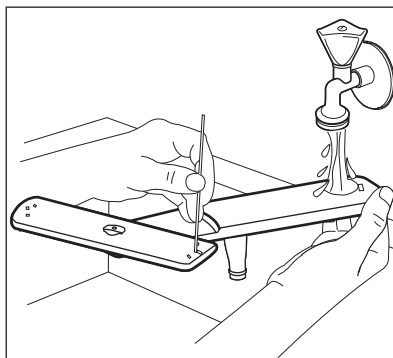

3. To install the spray arm back, press it downwards.

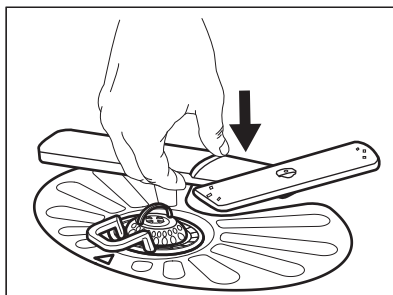

### 10.6 Cleaning the upper spray arm

We recommend to clean the upper spray arm regularly to prevent soil from clogging the holes.

Clogged holes can cause unsatisfactory washing results.

1. Pull out the upper basket.
2. To detach the spray arm from the basket, press the spray arm upwards and simultaneously turn it clockwise.

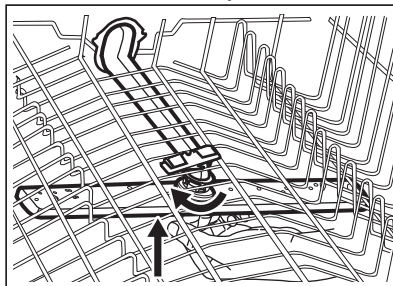

3. Wash the spray arm under running water. Use a thin pointed tool, e.g. a

toothpick, to remove particles of soil from the holes.

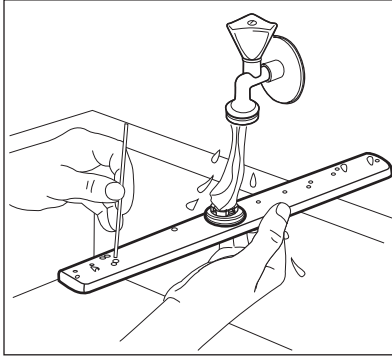

4. To install the spray arm back, press the spray arm upwards and simultaneously turn it counterclockwise until it locks into place.

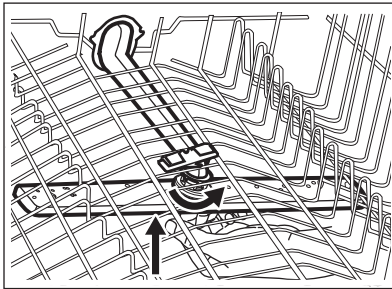

## 10.7 Cleaning the ceiling spray arm

We recommend to clean the ceiling spray arm regularly to prevent soil from clogging the holes. Clogged holes can cause unsatisfactory washing results.

The ceiling spray arm is placed on the ceiling of the appliance. The spray arm (C) is installed in the delivery tube (A) with the mounting element (B).

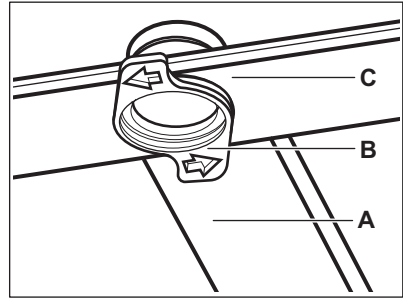

1. Move the upper basket to the lowest level to reach the spray arm more easily.
2. Pull out the cutlery drawer to the maximum.
3. To detach the spray arm (C) from the delivery tube (A), turn the mounting element (B) counterclockwise and pull the spray arm downwards.
4. Wash the spray arm under running water. Use a thin pointed tool, e.g. a toothpick, to remove particles of soil from the holes. Run the water through the holes to wash soil particles away from the inside.

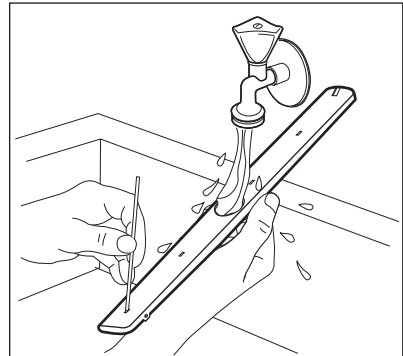

5. To install the spray arm (C) back, insert the mounting element (B) in the spray arm and fix it in the delivery tube (A) by turning it clockwise. Make sure that the mounting element locks into place.

# 11. TROUBLESHOOTING



## WARNING!

Improper repair of the appliance may pose a danger to the safety of the user. Any repairs must be performed by qualified personnel.

## to contact an Authorised Service Centre.

Refer to the below table for information on possible problems.

With some problems, the display shows an alarm code.

### The majority of problems that may occur can be solved without the need

Problem and alarm code	Possible cause and solution
You cannot activate the appliance.	<ul style="list-style-type: none"> <li>• Make sure that the mains plug is connected to the mains socket.</li> <li>• Make sure that there is no damaged fuse in the fuse box.</li> </ul>
The programme does not start.	<ul style="list-style-type: none"> <li>• Make sure that the appliance door is closed.</li> <li>• If the delay start is set, cancel the setting or wait for the end of the countdown.</li> </ul>
The appliance does not fill with water. The display shows <b>i10</b> or <b>i11</b> .	<ul style="list-style-type: none"> <li>• Make sure that the water tap is open.</li> <li>• Make sure that the pressure of the water supply is not too low. For this information, contact your local water authority.</li> <li>• Make sure that the water tap is not clogged.</li> <li>• Make sure that the filter in the inlet hose is not clogged.</li> <li>• Make sure that the inlet hose has no kinks or bends.</li> </ul>
The appliance does not drain the water. The display shows <b>i20</b> .	<ul style="list-style-type: none"> <li>• Make sure that the sink spigot is not clogged.</li> <li>• Make sure that the filter in the outlet hose is not clogged.</li> <li>• Make sure that the interior filter system is not clogged.</li> <li>• Make sure that the drain hose has no kinks or bends.</li> </ul>
The anti-flood device is on. The display shows <b>i30</b> .	<ul style="list-style-type: none"> <li>• Close the water tap and contact an Authorised Service Centre.</li> </ul>
The appliance stops and starts more times during operation.	<ul style="list-style-type: none"> <li>• It is normal. It provides optimal cleaning results and energy savings.</li> </ul>
The programme lasts too long.	<ul style="list-style-type: none"> <li>• If the delay start option is set, cancel the delay setting or wait for the end of the countdown.</li> <li>• Activating options can increase the programme duration.</li> </ul>
The displayed programme duration is different than the duration in the consumption values table.	<ul style="list-style-type: none"> <li>• The pressure and the temperature of the water, the variations of the mains supply, the options, the quantity of dishes and the degree of soil can change the programme duration.</li> </ul>

Problem and alarm code	Possible cause and solution
The remaining time in the display increases and skips nearly to the end of the programme duration.	<ul style="list-style-type: none"> <li>This is not a defect. The appliance is working correctly.</li> </ul>
Small leak from the appliance door.	<ul style="list-style-type: none"> <li>The appliance is not levelled. Loosen or tighten the adjustable feet (if applicable).</li> <li>The appliance door is not centred on the tub. Adjust the rear foot (if applicable).</li> </ul>
The appliance door is difficult to close.	<ul style="list-style-type: none"> <li>The appliance is not levelled. Loosen or tighten the adjustable feet (if applicable).</li> <li>Parts of the tableware are protruding from the baskets.</li> </ul>
The appliance door opens during the wash cycle.	<ul style="list-style-type: none"> <li>The AirDry function is activated. You can deactivate the function. Refer to "<b>Basic settings</b>".</li> </ul>
Rattling or knocking sounds from the inside of the appliance.	<ul style="list-style-type: none"> <li>The tableware is not properly arranged in the baskets. Refer to basket loading leaflet.</li> <li>Make sure that the spray arms can rotate freely.</li> </ul>
The appliance trips the circuit-breaker.	<ul style="list-style-type: none"> <li>The amperage is insufficient to supply simultaneously all the appliances in use. Check the socket amperage and the capacity of the meter or turn off one of the appliances in use.</li> <li>Internal electrical fault of the appliance. Contact an Authorised Service Centre.</li> </ul>

Once you have checked the appliance, deactivate and activate the appliance. If the problem occurs again, contact an Authorised Service Centre.

For alarm codes not described in the table, contact an Authorised Service Centre.





#### **WARNING!**

We do not recommend using the appliance until the problem has been completely fixed. Unplug the appliance and do not plug it in again until you are certain that it operates correctly.

The PNC can be found on the rating plate on the appliance door. You can also check the PNC on the control panel.

Before checking the PNC, make sure the appliance is in the programme selection.

- Press and hold simultaneously  and <sup>AUTO</sup><sub>Sense</sub> for about 3 seconds. The display shows the PNC of your appliance.
- To exit the PNC presentation, press and hold simultaneously  and <sup>AUTO</sup><sub>Sense</sub> for about 3 seconds. The appliance returns to the programme selection.

## 11.1 The product number code (PNC)

If you contact an Authorised Service Centre, you need to provide the product number code of your appliance.

## 11.2 The dishwashing and drying results are not satisfactory

Problem	Possible cause and solution
Poor washing results.	<ul style="list-style-type: none"> <li>• Refer to <b>"Daily use"</b>, <b>"Hints and tips"</b> and the basket loading leaflet.</li> <li>• Use more intensive washing programme.</li> <li>• Activate the ExtraPower option to improve the washing results of a selected programme.</li> <li>• Clean spray arm jets and filter. Refer to <b>"Care and Cleaning"</b>.</li> <li>• Make sure that the spray arms are correctly positioned.</li> </ul>
Poor drying results.	<ul style="list-style-type: none"> <li>• Tableware was left for too long inside the closed appliance. Activate AirDry to set the automatic opening of the door and to improve the drying performance.</li> <li>• There is no rinse aid or the dosage of rinse aid is not sufficient. Fill the rinse aid dispenser or set the level of rinse aid to a higher level.</li> <li>• The quality of the rinse aid can be the cause.</li> <li>• We recommend to use rinse aid always, even in combination with multi-tablets.</li> <li>• Plastic items may need to be towel dried.</li> <li>• The programme does not have the drying phase. Refer to <b>"Programmes overview"</b>.</li> </ul>
There are whitish streaks or bluish layers on glasses and dishes.	<ul style="list-style-type: none"> <li>• The released quantity of rinse aid is too high. Adjust the rinse aid level to a lower level.</li> <li>• The quantity of detergent is too high.</li> </ul>
There are stains and dry water drops on glasses and dishes.	<ul style="list-style-type: none"> <li>• The released quantity of rinse aid is not sufficient. Adjust the rinse aid level to a higher level.</li> <li>• The quality of the rinse aid can be the cause.</li> </ul>
The interior of the appliance is wet.	<ul style="list-style-type: none"> <li>• This is not a defect of the appliance. Humid air condensates on the appliance walls.</li> </ul>
Unusual foam during washing.	<ul style="list-style-type: none"> <li>• Use the detergent designed specifically for dishwashers.</li> <li>• Use a detergent from a different manufacturer.</li> <li>• Do not pre-rinse dishes under running water.</li> </ul>
Traces of rust on cutlery.	<ul style="list-style-type: none"> <li>• Silver and stainless steel cutlery were placed together. Do not put silver and stainless steel items close together.</li> </ul>
There are residues of detergent in the dispenser at the end of the programme.	<ul style="list-style-type: none"> <li>• The detergent tablet was stuck in the dispenser and therefore was not completely washed away by water.</li> <li>• Water cannot wash away the detergent from the dispenser. Make sure that the spray arms are not blocked or clogged.</li> <li>• Make sure that items in the baskets do not impede the lid of the detergent dispenser from opening.</li> </ul>

Problem	Possible cause and solution
Odours inside the appliance.	<ul style="list-style-type: none"> <li>Refer to <b>"Internal cleaning"</b>.</li> <li>Start the Machine Care programme with a descaler or a cleaning product designed for dishwashers.</li> </ul>
Limescale deposits on the tableware, on the tub and on the inside of the door.	<ul style="list-style-type: none"> <li>Start the Machine Care programme with a descaler designed for dishwashers.</li> <li>If limescale deposits still remain, clean the appliance with appliance cleaners which are particularly suitable for this purpose.</li> <li>Try a different detergent.</li> <li>Contact the detergent manufacturer.</li> </ul>
Dull, discoloured or chipped tableware.	<ul style="list-style-type: none"> <li>Make sure that only dishwasher-safe items are washed in the appliance.</li> <li>Load and unload the basket carefully. Refer to the basket loading leaflet.</li> <li>Place delicate items in the upper basket.</li> <li>Activate the GlassCare option to ensure special care for glassware and delicate items.</li> </ul>



Refer to **"Before first use"**, **"Daily use"**, or **"Hints and tips"** for other possible causes.

## 12. TECHNICAL INFORMATION

Dimensions	Width / height / depth (mm)	596 / 818 - 898 / 550
Electrical connection <sup>1)</sup>	Voltage (V)	220 - 240
	Frequency (Hz)	50
	Wattage (W)	1950
Water supply pressure	bar (minimum and maximum)	0.5 - 10
	kPa (minimum and maximum)	50 - 1000
Water supply	Cold water <sup>2)</sup>	min 5 °C
Capacity	Place settings	14

<sup>1)</sup> Refer to the rating plate for other values.

<sup>2)</sup> Cold water connection is recommended for best washing performance.



## 13. INSTALLATION

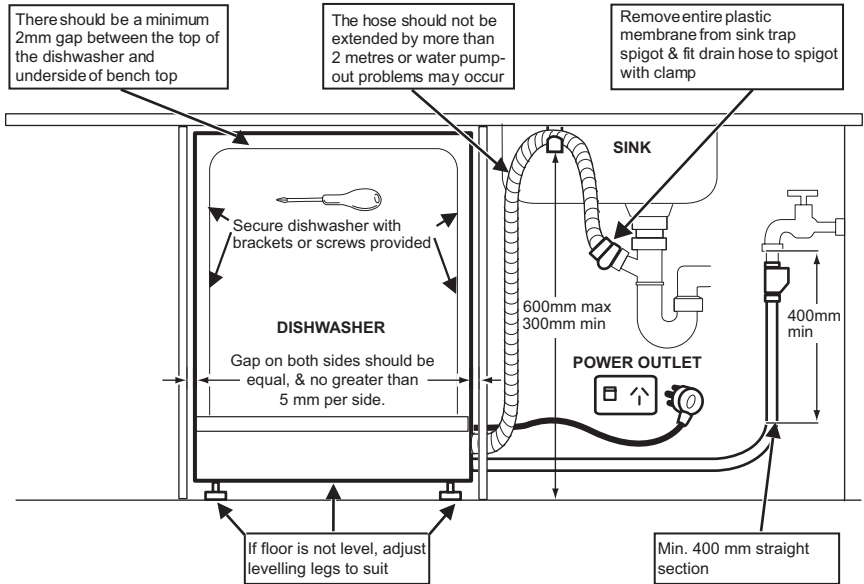

Install the appliance under a kitchen counter.

Put the appliance adjacent to a water tap and a water drain.

For the venting of the appliance only water hoses and mains cable openings are necessary.

### 13.1 Adjusting the height of the appliance

1. To adjust the front height, turn the 2 front feet counterclockwise to raise the appliance.

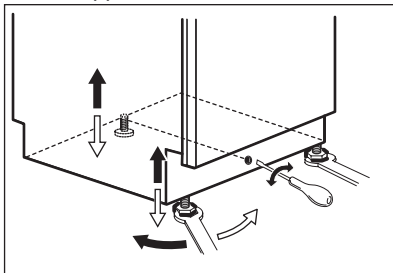

2. To adjust the rear height, turn the middle screw counterclockwise to raise the appliance.

### 13.2 Adjusting the level of the appliance

Correct levelling of the appliance allows the door to close and seal properly.

If the door does not close correctly, raise or lower the adjustable feet to level the appliance.

### 13.3 Water inlet hose

Connect the inlet hose to a water tap with an external BSP thread spout of 3/4".

For best washing performance, it is recommended to connect the appliance to a cold water supply.

Energy savings can be made by connecting the appliance to a Solar water system and using economy options, however the water temperature must not exceed 60° C.

### Inlet water supply

- Water pressure: 1000 kPa max - 50 kPa min.
- Water flow rate 10 L / minute min.
- If water pressure is in excess of 1000 kPa, a pressure reducing valve should be used. Check for leaks.
- If water temperature is in excess of 60° C, a tempering valve should be used. Check for leaks.



#### CAUTION!

Always use new hoses when you connect the appliance to the water mains. Old hoses must not be used. The water inlet hose must be examined at an interval of twelve months for deterioration and replaced if necessary.

The water pressure must be in the limits indicated in the chapter "TECHNICAL INFORMATION". Make sure that the local water authority gives you the average mains pressure in your area.

In order to pass the safety valve through the kitchen cabinets, an opening of at least 45 mm x 90 mm is needed.

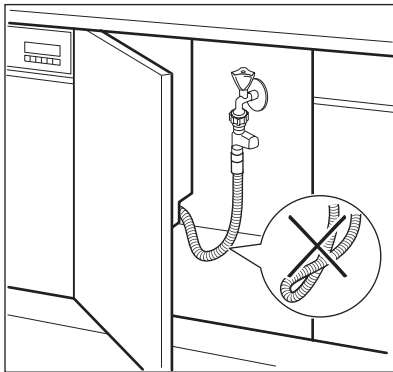

### 13.4 Water drain hose

The highest point of the drain hose must be no more than 600 mm from the floor and must have a continuous fall to the plumbing connection.

The drain hose can be lengthened using additional lengths and connectors. These must be purchased from Electrolux Spare Parts. The extension length must not exceed 2 metres.

The drain hose must be free of obstructions.

Remove the sink plug when the appliance drains the water to prevent that the water goes back into the appliance.

The appliance has a security feature to prevent dirty water going back into the appliance. If the spigot of the sink has a non-return valve, this valve can cause the appliance to drain incorrectly. remove the non-return valve.

If you connect the water drain hose to a trap spigot under the sink, remove the plastic membrane. If you do not remove the membrane, remaining food can cause a blockage in the drain hose spigot.

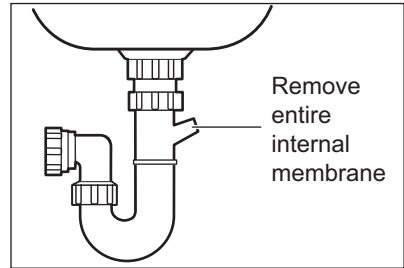

## 14. WARRANTY

FOR SALES IN AUSTRALIA AND NEW ZEALAND

ALL AEG BRANDED APPLIANCES

**This document sets out the terms and conditions of the product warranties for AEG Appliances. It is an important document. Please keep it with your**

**proof of purchase documents in a safe place for future reference should there be a manufacturing defect in your Appliance. This warranty is in addition to other rights you may have under the Australian Consumer Law.**

1. In this warranty:

- a) 'ACL' or 'Australian Consumer Law' means Schedule 2 to the Competition and Consumer Act 2010;
  - b) 'Appliance' means any Electrolux product purchased by you and accompanied by this document;
  - c) 'ASC' means Electrolux's authorised serviced centres;
  - d) 'AEG' is the brand controlled by Electrolux Home Products Pty Ltd of 163 O'Riordan Street, Mascot NSW 2020, ABN 51 004 762 341 in respect of Appliances purchased in Australia and Electrolux (NZ) Limited (collectively "Electrolux") of 3-5 Niall Burgess Road, Mount Wellington, in respect of Appliances purchased in New Zealand;
  - e) 'Warranty Period' means the period specified in clause 3 of this warranty;
  - f) 'you' means the purchaser of the Appliance not having purchased the Appliance for re-sale, and 'your' has a corresponding meaning.
2. **Application:** This warranty only applies to new Appliances, purchased and used in Australia or New Zealand and is in addition to (and does not exclude, restrict, or modify in any way) other rights and remedies under a law to which the Appliances or services relate, including any non-excludable statutory guarantees in Australia and New Zealand.
  3. **Warranty Period:** Subject to these terms and conditions, this warranty continues for in Australia for a period of 60 months and in New Zealand for a period of 60 months, following the date of original purchase of the Appliance.
  4. **Repair or replace warranty:** During the Warranty Period, Electrolux or its ASC will, at no extra charge if your Appliance is readily accessible for service, without special equipment and subject to these terms and conditions, repair or replace any parts which it considers to be defective. Electrolux may, in its absolute discretion, choose whether the remedy offered for a valid warranty claim is repair or replacement. Electrolux or its ASC may use refurbished parts to repair your Appliance. You agree that any replaced Appliances or parts become the property of Electrolux.
  5. **Travel and transportation costs:** Subject to clause 7, Electrolux will bear the reasonable cost of transportation, travel and delivery of the Appliance to and from Electrolux or its ASC. Travel and transportation will be arranged by Electrolux as part of any valid warranty claim.
  6. **Proof of purchase** is required before you can make a claim under this warranty.
  7. **Exclusions:** You may not make a claim under this warranty unless the defect claimed is due to faulty or defective parts or workmanship. This warranty does not cover:
    - a) light globes, batteries, filters or similar perishable parts;
    - b) parts and Appliances not supplied by Electrolux;
    - c) cosmetic damage which does not affect the operation of the Appliance;
    - d) damage to the Appliance caused by:
      - negligence or accident;
      - misuse or abuse, including failure to properly maintain or service;
      - improper, negligent or faulty servicing or repair works done by anyone other than an Electrolux authorised repairer or ASC;
      - normal wear and tear;
      - power surges, electrical storm damage or incorrect power supply;
      - incomplete or improper installation;
      - incorrect, improper or inappropriate operation;
      - insect or vermin infestation;
      - failure to comply with any additional instructions supplied with the Appliance;

In addition, Electrolux is not liable under this warranty if:

- the Appliance has been, or Electrolux reasonably believes that the Appliance has been, used for purposes other than those for which the Appliance was intended, including where the Appliance has been used for any non-domestic purpose;
  - the Appliance is modified without authority from Electrolux in writing;
  - the Appliance's serial number or warranty seal has been removed or defaced.
8. **How to claim under this warranty:** To enquire about claiming under this warranty, please follow these steps:
- a. carefully check the operating instructions, user manual and the terms of this warranty;
  - b. have the model and serial number of the Appliance available;
  - c. have the proof of purchase (e.g. an invoice) available;
  - d. telephone the numbers shown below.
9. **Australia:** For Appliances and services provided by Electrolux in Australia: Electrolux goods come with guarantees that cannot be excluded under the Australian Consumer Law. You are entitled to a replacement or refund for a major failure and for compensation for any other reasonably foreseeable loss or damage. You are also entitled to have the Appliance repaired or replaced if the Appliance fails to be of acceptable quality and the failure does not amount to a major failure. 'Acceptable quality' and 'major failure' have the same meaning as referred to in the ACL.
10. **New Zealand:** For Appliances and services provided by Electrolux in New Zealand, the Appliances come with a guarantee by Electrolux pursuant to the provisions of the Consumer Guarantees Act, the Sale of Goods Act and the Fair Trading Act. Where the Appliance was purchased in New Zealand for commercial purposes the Consumer Guarantee Act does not apply.
11. **Confidentiality:** You accept that if you make a warranty claim, Electrolux and its agents including ASC may exchange information in relation to you to enable Electrolux to meet its obligations under this warranty.

**Important Notice**

Before calling for service, please ensure that the steps listed in clause 8 above have been followed.

**SERVICE AUSTRALIA**  
aeg.com/au

**FOR SERVICE**

or to find the address of your nearest authorised service centre in Australia

**PLEASE CALL 1300 363 664**

**OR EMAIL**

**customercare@aegaustralia.com.au**

For the cost of a local call (Australia only)

**FOR SPARE PARTS**

or to find the address of your nearest spare parts centre in Australia

**PLEASE CALL 13 13 50**

**OR EMAIL**

**customercare@aegaustralia.com.au**

For the cost of a local call (Australia only)

**SERVICE NEW ZEALAND**  
aegnewzealand.co.nz

**FOR SERVICE**

or to find the address of your nearest authorised service centre in New Zealand

**PLEASE CALL 0800 234 234**

**OR EMAIL**

**customercare@electrolux.co.nz**

(New Zealand only)

**FOR SPARE PARTS**

or to find the address of your nearest spare parts centre in New Zealand

**PLEASE CALL 0800 10 66 20**

**OR EMAIL**

**customercare@electrolux.co.nz**

(New Zealand only)

AEG\_Warr\_May\_17

## 15. ENVIRONMENTAL CONCERNS

Recycle materials with the symbol . Put the packaging in relevant containers to recycle it. Help protect the environment and human health by recycling waste of electrical and electronic appliances. Do not dispose of

appliances marked with the symbol  with the household waste. Return the product to your local recycling facility or contact your municipal office.





