

Built-in Oven

User manual

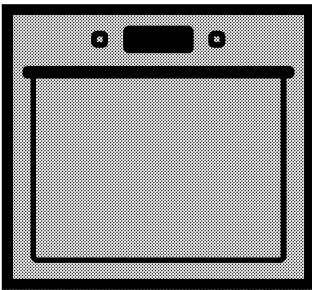

BB060B2PB

EN

285.4605.08/R.AA/11.09.2017

Please read this user manual first!

Dear Customer,

Thank you for purchasing this Beko product. We hope that you get the best results from your product which has been manufactured with high quality and state-of-the-art technology. Therefore, please read this entire user manual and all other accompanying documents carefully before using the product and keep it as a reference for future use. If you handover the product to someone else, give the user manual as well. Follow all warnings and information in the user manual.

Remember that this user manual is also applicable for several other models. Differences between models will be identified in the manual.

Explanation of symbols

Throughout this user manual the following symbols are used:

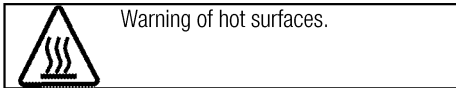
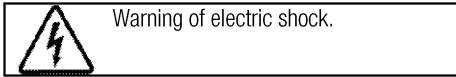
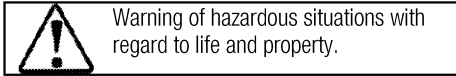
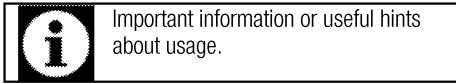

Arçelik A.Ş.
Karaağaç caddesi No:2-6
34445 Sütlüce/İstanbul/TURKEY
Made in TURKEY



This product was manufactured using the latest technology in environmentally friendly conditions.

TABLE OF CONTENTS

1 Important instructions and warnings for safety and environment 4

General safety	4
Electrical safety	4
Product safety	5
Intended use	7
Safety for children.....	7
Disposing of the old product.....	7

2 General information 9

Overview	9
Package contents	10
Technical specifications	11

3 Installation 12

Before installation	12
Installation and connection	13
Future Transportation.....	15

4 Preparation 16

Tips for saving energy	16
Initial use	16
Time setting	16
First cleaning of the appliance	16
Initial heating.....	16

5 How to operate the oven 18

General information on baking, roasting and grilling	18
How to operate the electric oven	18
Operating modes.....	18
How to operate the oven control unit	21
Cooking times table.....	25
How to operate the grill.....	27
Cooking times table for grilling.....	27

6 Maintenance and care 28

General information	28
Cleaning the control panel	28
Cleaning the oven	28
Removing the oven door	30
Removing the door inner glass	30
Replacing the oven lamp.....	32

7 Troubleshooting 33

1 Important instructions and warnings for safety and environment

This section contains safety instructions that will help protect from risk of personal injury or property damage. Failure to follow these instructions shall void any warranty.

General safety

- The appliance is not intended for use by persons (including children) with reduced physical, sensory or mental capabilities, or lack of experience and knowledge, unless they have been given supervised or instruction concerning use of the appliance by a responsible person for their safety.
- Young children should be supervised to ensure that they do not play with the appliance.
- Installation and repair procedures must always be performed by Authorised Service Agents. The manufacturer shall not be held responsible for damages arising from procedures carried out by unauthorised persons which may also void the warranty. Before installation, read the instructions carefully.
- Do not operate the product if it is defective or has any visible damage.

- Control that the product function knobs are switched off after every use.

Electrical safety

- If the product has a failure, it should not be operated unless it is repaired by the Authorised Service Agent. There is the risk of electric shock!
- Only connect the product to a grounded outlet/line with the voltage and protection as specified in the "Technical specifications". Have the grounding installation made by a qualified electrician while using the product with or without a transformer. Our company shall not be liable for any problems arising due to the product not being earthed in accordance with the local regulations.
- Never wash the product by spreading or pouring water onto it! There is the risk of electric shock!
- Never touch the plug with wet hands! Never unplug by pulling on the cable, always pull out by grabbing the plug.
- The product must be unplugged during installation, maintenance, cleaning and repairing procedures.
- If the power connection cable for the product is damaged, it must

be replaced by the manufacturer, its service agent or similar qualified persons in order to avoid a hazard.

- The appliance must be installed so that it can be completely disconnected from the network. The separation must be provided either by a mains plug, or a switch built into the fixed electrical installation, according to construction regulations.
- If the electrical supply is restricted, means of all-pole disconnection must be accessible and incorporated in the fixed wiring in accordance with the wiring rules.
- Rear surface of the oven gets hot when it is in use. Make sure that the gas/electrical connection does not contact the rear surface; otherwise, connections can get damaged.
- Do not trap the mains cable between the oven door and frame and do not route it over hot surfaces. Otherwise, cable insulation may melt and cause fire as a result of short circuit.
- Any work on electrical equipment and systems should only be carried out by authorised and qualified persons.
- In case of any damage, switch off the product and disconnect it

from the mains. To do this, turn off the fuse at home.

- Make sure that fuse rating is compatible with the product.

Product safety

- Never use the product when your judgment or coordination is impaired by the use of alcohol and/or drugs.
- Be careful when using alcoholic drinks in your dishes. Alcohol evaporates at high temperatures and may cause fire since it can ignite when it comes into contact with hot surfaces.
- Do not place any flammable materials close to the product as the sides may become hot during use.
- During use the appliance becomes hot. Care should be taken to avoid touching heating elements inside the oven.
- Keep all ventilation slots clear of obstructions.
- Do not heat closed tins and glass jars in the oven. The pressure that would build-up in the tin/jar may cause it to burst.
- Do not place baking trays, dishes or aluminium foil directly onto the bottom of the oven. The heat accumulation might damage the bottom of the oven.
- Do not use harsh abrasive cleaners or sharp metal scrapers to clean the oven glass door since

they can scratch the surface, which may result in shattering of the glass.

- Do not use a steam cleaner to clean this appliance.
- This oven must not be installed behind a decorative door in order to avoid overheating.
- (Varies depending on the product model.)

Placing the wire shelf and tray onto the wire racks properly
It is important to place the wire shelf and/or tray onto the rack properly. Slide the wire shelf or tray between 2 rails and make sure that it is balanced before placing food on it (Please see the following figure).

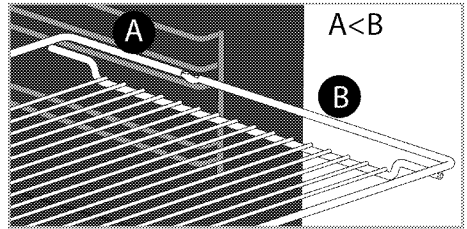
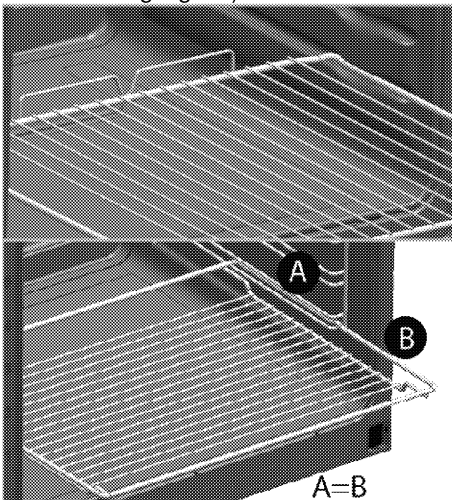

- Do not use the product if the front door glass removed or cracked.
- Oven handle is not towel dryer. Do not hang up towel, gloves, or similar textile products when the grill function is at open door.
- Always use heat resistant oven gloves when putting in or removing dishes into/from the hot oven.
- **WARNING:** Ensure the appliance is switched off before replacing the lamp to avoid the possibility of electric shock.
- During the pyrolytic cleaning function, please note that outside surfaces may become hotter than usual. Please ensure children are kept away.
- Excess spillage must be removed before starting the pyrolytic cleaning function.

For the reliability of the fire of the product;

- Make sure the plug is fitting to socket as well for not cause to spark.
- Do not use damaged or cutted or extension cable except the original cable.

- Make sure that not whether liquid or moisture on the socket is plugged to product .

Intended use

- This product is designed for domestic use. Commercial use will void the guarantee.
- This appliance is for cooking purposes only. It must not be used for other purposes, for example room heating.
- This product should not be used for warming the plates under the grill, drying towels, dish cloths etc. by hanging them on the oven door handles. This product should also not be used for room heating purposes.
- The manufacturer shall not be liable for any damage caused by improper use or handling errors.
- The oven can be used for defrosting, baking, roasting and grilling food.

Safety for children

- **WARNING:** Accessible parts will become hot when in use. Young children should be kept away.
- **WARNING:** Accessible parts may become hot when the grill in use. Children should be kept away.
- The packaging materials will be dangerous for children. Keep the packaging materials away from children. Please dispose of all

parts of the packaging according to environmental standards.

- Electrical and/or gas products are dangerous to children. Keep children away from the product when it is operating and do not allow them to play with the product.
- Do not place any items above the appliance that children may reach for.
- When the door is open, do **not** load any heavy object on it and do **not** allow children to sit on it. It may overturn or door hinges may get damaged.

Disposing of the old product

Compliance with the WEEE Directive and Disposing of the Waste Product:



This product complies with EU WEEE Directive (2012/19/EU). This product bears a classification symbol for waste electrical and electronic equipment (WEEE).

This product has been manufactured with high quality parts and materials which can be reused and are suitable for recycling. Do not dispose of the waste product with normal domestic and other wastes at the end of its service life. Take it to the collection center for the recycling of electrical and electronic equipment. Please

consult your local authorities to learn about these collection centers.

Compliance with RoHS Directive:

The product you have purchased complies with EU RoHS Directive (2011/65/EU). It does not contain harmful and prohibited materials specified in the Directive.

Package information

- Packaging materials of the product are manufactured from recyclable materials in accordance with our National Environment Regulations. Do not dispose of the packaging materials together with the domestic or other wastes. Take them to the packaging material collection points designated by the local authorities.

2 General information

Overview

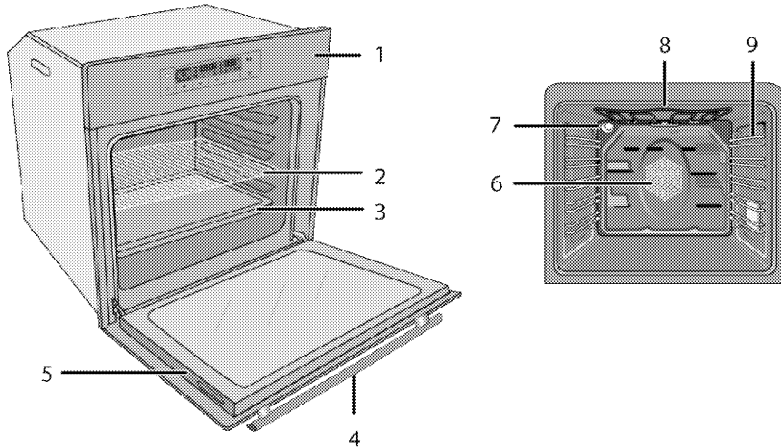

- | | | | |
|---|---------------|---|--------------------------------|
| 1 | Control panel | 6 | Fan motor (behind steel plate) |
| 2 | Wire shelf | 7 | Lamp |
| 3 | Tray | 8 | Top heating element |
| 4 | Handle | 9 | Shelf positions |
| 5 | Door | | |

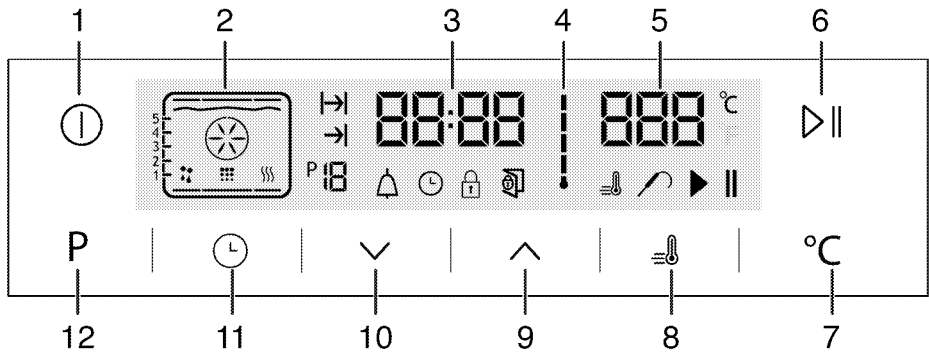

- | | | | |
|---|-------------------------------|----|------------------------------------|
| 1 | ON/OFF key | 7 | Temperature setting key |
| 2 | Function display | 8 | Booster symbol (rapid pre-heating) |
| 3 | Current time indicator field | 9 | Plus key |
| 4 | Oven Inner Temperature symbol | 10 | Minus key |
| 5 | Temperature indicator field | 11 | Adjustment key |
| 6 | Start/stop cooking key | 12 | Return Key to function display |

Package contents



Accessories supplied can vary depending on the product model. Not every accessory described in the user manual may exist on your product.

1. **User manual**

2. **Oven tray**

Used for pastries, frozen foods and big roasts.

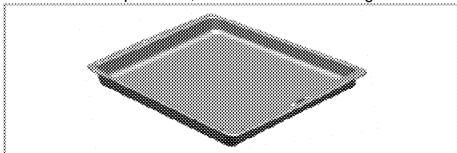

3. **Deep tray**

Used for pastries, large roasts, juicy dishes, and for collecting the fat while grilling.

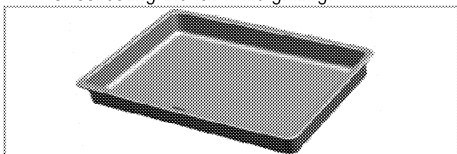

4. **Wire Shelf**

Used for roasting and for placing the food to be baked, roasted or cooked in casserole dishes to the desired rack.

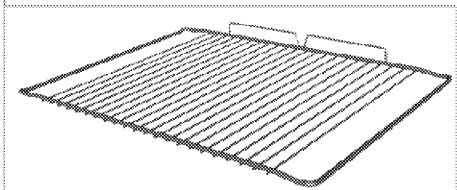
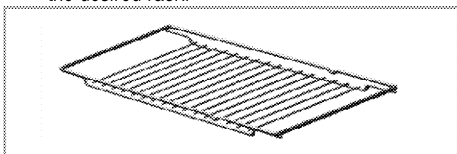

5. **Small wire shelf**

It is placed into the tray (if supplied) in order to collect the dripping fat while grilling so that the oven is kept clean.

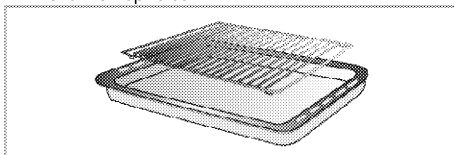

6. **Placing the wire shelf and tray onto the telescopic racks properly**
(This feature is optional. It may not exist on your product.)

Telescopic racks allow you to install and remove the trays and wire shelf easily.

When using the tray and wire shelf with telescopic racks, make sure that the pins at the rear section of the telescopic rack stands against the edges of the wire shelf and tray.

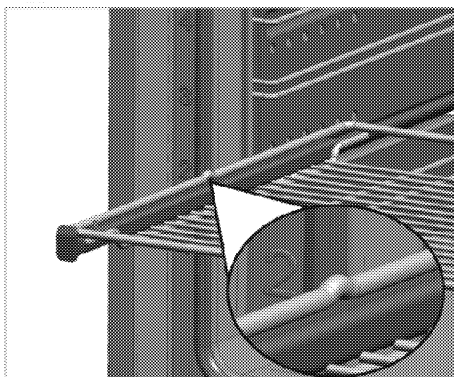
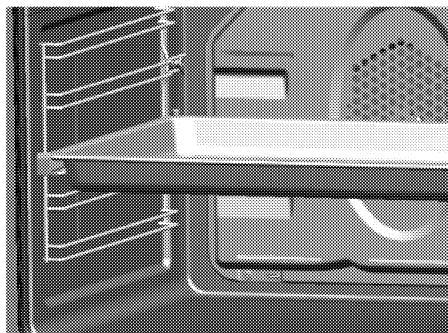

Technical specifications

Voltage / frequency	220-240 V ~ 50 Hz
Total power consumption	3.1 kW
Fuse	min. 16 A
Cable type / section	min.H05VV-FG 3 x 1,5 mm ²
External dimensions (height / width / depth)	595 mm/594 mm/567 mm
Installation dimensions (height / width / depth)	**590 or 600 mm/560 mm/min. 550 mm
Main oven	Multifunction oven
Inner lamp	15/25 W
Grill power consumption	2.2 kW

Basics: Information on the energy label of electrical ovens is given in accordance with the EN 60350-1 / IEC 60350-1 standard. Those values are determined under standard load with bottom-top heater or fan assisted heating (if any) functions.

Energy efficiency class is determined in accordance with the following prioritization depending on whether the relevant functions exist on the product or not. 1-Cooking with eco-fan, 2- Turbo slow cooking, 3- Turbo cooking, 4- Fan assisted bottom/top heating, 5-Top and bottom heating.

** See. *Installation, page 12.*



Technical specifications may be changed without prior notice to improve the quality of the product.



Figures in this manual are schematic and may not exactly match your product.



Values stated on the product labels or in the documentation accompanying it are obtained in laboratory conditions in accordance with relevant standards. Depending on operational and environmental conditions of the product, these values may vary.

3 Installation

Product must be installed by a qualified person in accordance with the regulations in force. The manufacturer shall not be held responsible for damages arising from procedures carried out by unauthorised persons which may also void the warranty.



Preparation of location and electrical installation for the product is under customer's responsibility.



DANGER:

The product must be installed in accordance with all local electrical regulations.



DANGER:

Prior to installation, visually check if the product has any defects on it. If so, do not have it installed.

Damaged products cause risks for your safety.

- Surfaces, synthetic laminates and adhesives used must be heat resistant (100 °C minimum).
- Kitchen cabinets must be set level and fixed.
- If there is a drawer beneath the oven, a shelf must be installed between oven and drawer.
- Carry the appliance with at least two persons.



Do not install the appliance next to refrigerators or freezers. The heat emitted by the appliance will lead to an increased energy consumption of cooling appliances.



The door and/or handle must not be used for lifting or moving the appliance.



If the appliance has wire handles, push the handles back into the side walls after moving the appliance.

Before installation

The appliance is intended for installation in commercially available kitchen cabinets. A safety distance must be left between the appliance and the kitchen walls and furniture. See figure (values in mm).

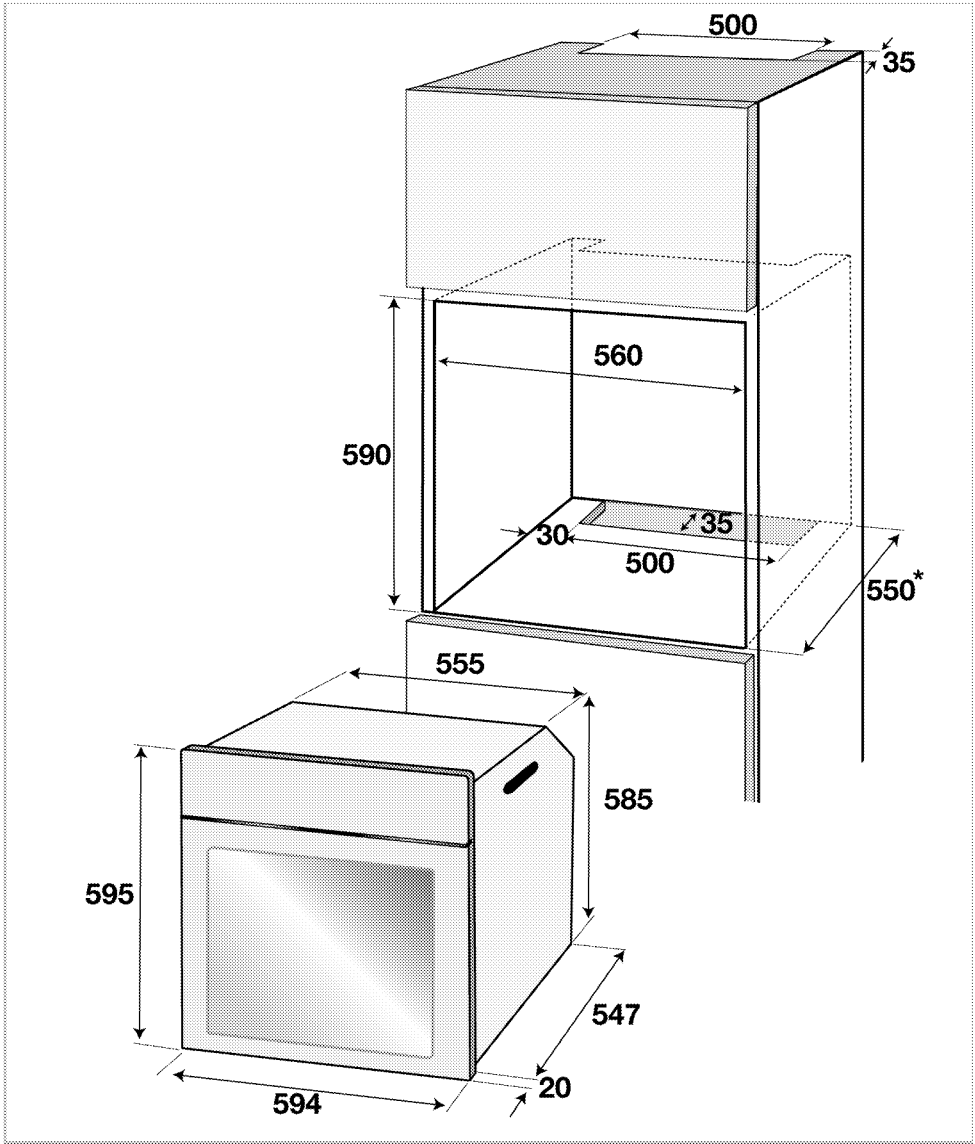

* min.

Installation and connection

- The product must be installed in accordance with all local gas and electrical regulations.

Electrical connection

Connect the product to a grounded outlet/line protected by a fuse of suitable capacity as stated in the "Technical specifications" table. Have the grounding installation made by a qualified electrician while using

the product with or without a transformer. The Manufacturer shall not be liable for any damages that will arise due to using the product without a grounding installation in accordance with the local regulations.

**DANGER:**

The product must be connected to the mains supply only by an authorised and qualified person. The product's warranty period starts only after correct installation. Manufacturer shall not be held responsible for damages arising from procedures carried out by unauthorised persons.

**DANGER:**

The power cable must not be clamped, bent or trapped or come into contact with hot parts of the product. A damaged power cable must be replaced by a qualified electrician. Otherwise, there is risk of electric shock, short circuit or fire!

- Connection must comply with national regulations.
- The mains supply data must correspond to the data specified on the type label of the product. Open the front door to see the type label.
- Power cable of your product must comply with the values in "Technical specifications" table.

**DANGER:**

Before starting any work on the electrical installation, disconnect the product from the mains supply. There is the risk of electric shock!

Connecting the power cable

1. If a power cable is not supplied together with your product, a power cable that you would select from the table (*Technical specifications, page 11*) in accordance with the electrical installation at your home must be connected to your product by following the instructions in cable diagram.

If it is not possible to disconnect all poles in the supply power, a disconnection unit with at least 3 mm contact clearance (fuses, line safety switches, contactors) must be connected and all the poles of this disconnection unit must be adjacent to (not above) the product in accordance with IEE directives. Failure to obey this instruction may cause operational problems and invalidate the product warranty.



Additional protection by a residual current circuit breaker is recommended.

2. Open the terminal block cover with a screwdriver.
3. Insert the power cable through the cable clamp below the terminal and secure it to the main body

with the integrated screw on cable clamping component.

4. Connect the cables according to the supplied diagram.

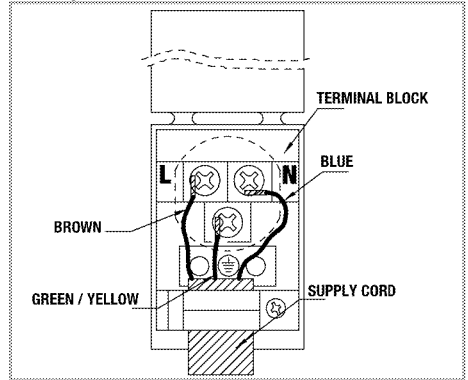

5. After completing the wire connections, close the terminal block cover.
6. Route the power cable so that it will not contact the product and get squeezed between the product and the wall.



Power cable must not be longer than 2 m because of safety reasons.

Installing the product

1. Slide the oven into the cabinet, align and secure it while making sure that the power cable is not broken and/or trapped.

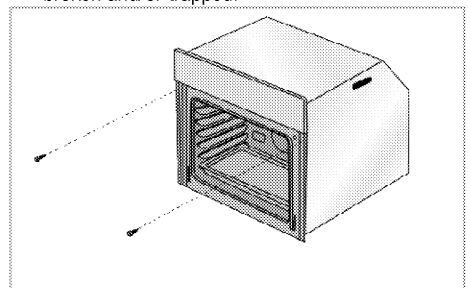

Secure the oven with 2 screws as illustrated.

For products with cooling fan (It may not exist on your product.)

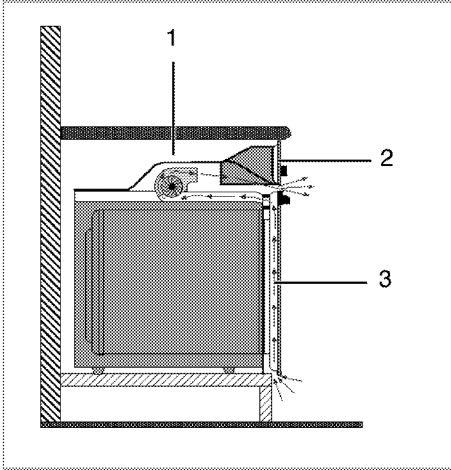

- 1 Cooling fan
- 2 Control panel
- 3 Door

The built-in cooling fan cools both the built-in cabinet and the front of the product.



Cooling fan continues to operate for about 20-30 minutes after the oven is switched off. If you have cooked by programming the timer of the oven, cooling fan will also be switched off at the end of the cooking time together with all functions.

Final check

1. Connect the power cable and switch on the product's fuse.
2. Check the functions.

Future Transportation

- Keep the product's original carton and transport the product in it. Follow the instructions on the carton. If you do not have the original carton, pack the product in bubble wrap or thick cardboard and tape it securely.
- To prevent the wire grill and tray inside the oven from damaging the oven door, place a strip of cardboard onto the inside of the oven door that lines up with the position of the trays. Tape the oven door to the side walls.
- Do not use the door or handle to lift or move the product.



Do not place any objects onto the product and move it in upright position.



Check the general appearance of your product for any damages that might have occurred during transportation.

4 Preparation

Tips for saving energy

The following information will help you to use your appliance in an ecological way, and to save energy:

- Use dark coloured or enamel coated cookware in the oven since the heat transmission will be better.
- While cooking your dishes, perform a preheating operation if it is advised in the user manual or cooking instructions.
- Do not open the door of the oven frequently during cooking.

- Try to cook more than one dish in the oven at the same time whenever possible. You can cook by placing two cooking vessels onto the wire shelf.
- Cook more than one dish one after another. The oven will already be hot.
- You can save energy by switching off your oven a few minutes before the end of the cooking time. Do not open the oven door.
- Defrost frozen dishes before cooking them.

Initial use

Time setting

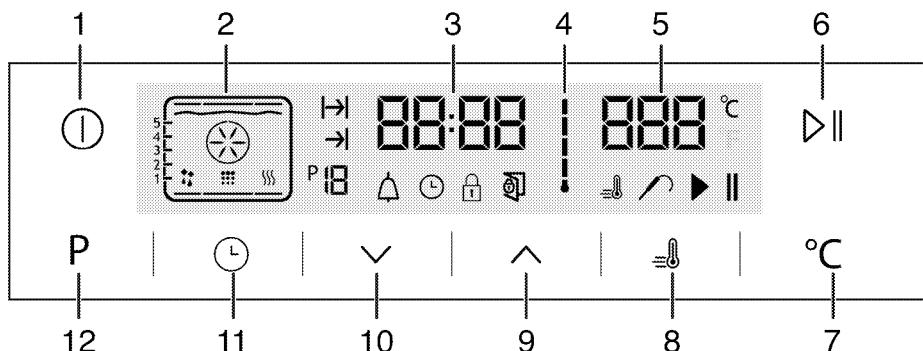

- 1 ON/OFF key
- 2 Function display
- 3 Current time indicator field
- 4 Oven Inner Temperature symbol
- 5 Temperature indicator field
- 6 Start/stop cooking key
- 7 Temperature setting key
- 8 Booster symbol (rapid pre-heating)
- 9 Plus key
- 10 Minus key
- 11 Adjustment key
- 12 Return Key to function display

1. At the initial operation of the oven symbol lights up, touch / keys to set the hour.
2. Confirm the setting by touching symbol and wait for 4 seconds without touching any keys to confirm.

If the current time is not set, time indicator will start increasing/moving up from 12:00. symbol will be activated to indicate that the current time has not been set. It will disappear as soon as the time is set.

First cleaning of the appliance



The surface might get damaged by some detergents or cleaning materials. Do not use aggressive detergents, cleaning powders/creams or any sharp objects during cleaning. Do not use harsh abrasive cleaners or sharp metal scrapers to clean the oven door glass since they can scratch the surface, which may result in shattering of the glass.

1. Remove all packaging materials.
2. Wipe the surfaces of the appliance with a damp cloth or sponge and dry with a cloth.

Initial heating

Heat up the product for about 30 minutes and then switch it off. Thus, any production residues or layers will be burnt off and removed.



WARNING

Hot surfaces cause burns!

Product may be hot when it is in use. Never touch the hot burners, inner sections of the oven, heaters and etc. Keep children away. Always use heat resistant oven gloves when putting in or removing dishes into/from the hot oven.

Electric oven

1. Take all baking trays and the wire grill out of the oven.
2. Close the oven door.
3. Select Static position.

Grill oven

1. Take all baking trays and the wire grill out of the oven.
2. Close the oven door.
3. Select the highest grill power; see *How to operate the grill, page 27*.
4. Operate the grill about 30 minutes.
5. Turn off your grill; see *How to operate the grill, page 27*



Smoke and smell may emit for a couple of hours during the initial operation. This is quite normal. Ensure that the room is well ventilated to remove the smoke and smell. Avoid directly inhaling the smoke and the smell that emits.

5 How to operate the oven

General information on baking, roasting and grilling



WARNING

Hot surfaces cause burns!
Product may be hot when it is in use. Never touch the hot burners, inner sections of the oven, heaters and etc. Keep children away. Always use heat resistant oven gloves when putting in or removing dishes into/from the hot oven.



DANGER:

Be careful when opening the oven door as steam may escape.
Exiting steam can scald your hands, face and/or eyes.

Tips for baking

- Use non-sticky coated appropriate metal plates or aluminum vessels or heat-resistant silicone moulds.
- Make best use of the space on the rack.
- Place the baking mould in the middle of the shelf.
- Select the correct rack position before turning the oven or grill on. Do not change the rack position when the oven is hot.
- Keep the oven door closed.

Tips for roasting

- Treating whole chicken, turkey and large piece of meat with dressings such as lemon juice and black pepper before cooking will increase the cooking performance.
- It takes about 15 to 30 minutes longer to roast meat with bones when compared to roasting the same size of meat without bones.
- Each centimeter of meat thickness requires approximately 4 to 5 minutes of cooking time.
- Let meat rest in the oven for about 10 minutes after the cooking time is over. The juice is better distributed all over the roast and does not run out when the meat is cut.
- Fish should be placed on the middle or lower rack in a heat-resistant plate.

Tips for grilling

When meat, fish and poultry are grilled, they quickly get brown, have a nice crust and do not get dry. Flat pieces, meat skewers and sausages are particularly suited for grilling as are vegetables with high water content such as tomatoes and onions.

- Distribute the pieces to be grilled on the wire shelf or in the baking tray with wire shelf in such

a way that the space covered does not exceed the size of the heater.

- Slide the wire shelf or baking tray with grill into the desired level in the oven. If you are grilling on the wire shelf, slide the baking tray to the lower rack to collect fats. Add some water in the tray for easy cleaning.



Foods that are not suitable for grilling carry the risk of fire. Only grill food which is suitable for intensive grilling heat.

Do not place the food too far in the back of the grill. This is the hottest area and fatty food may catch fire.

How to operate the electric oven

Rack positions (For models with wire shelf)

It is important to place the wire shelf onto the side rack correctly. Wire shelf must be inserted between the side racks as illustrated in the figure.

Do not let the wire shelf stand against the rear wall of the oven. Slide your wire shelf to the front section of the rack and settle it with the help of the door in order to obtain a good grill performance.

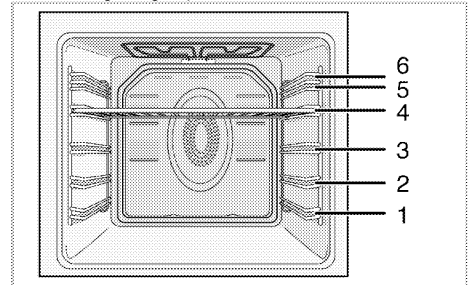

Operating modes

The order of operating modes shown here may be different from the arrangement on your product.

1. Top and bottom heating

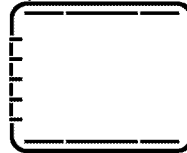

Food is heated simultaneously from the top and bottom. For example, it is suitable for cakes, pastries, or cakes and casseroles in baking moulds. Cook with one tray only.
Suitable rack position will be displayed on screen.

2. **Fan supported bottom/top heating**



Hot air heated by the bottom and top heaters is evenly distributed throughout the oven rapidly by means of the fan. Cook with one tray.

3. **Surf function**



Hot air heated by the fan assisted heater is evenly distributed throughout the oven rapidly by means of the fan. It is suitable for cooking your meals in different rack levels and preheating is not required in most cases. Suitable for cooking with multi trays.

4. **"3D" function**



Top heating, bottom heating and fan assisted heating are in operation. Food is cooked evenly and quickly all around. Cook with one tray only.

5. **Pizza function**



The bottom heating and fan assisted heating are in operation. Suitable for baking pizza.

6. **Full grill+Fan**



Hot air heated by the full grill is distributed very fast in the oven by means of the fan. It is suitable for grilling large amount of meat.

- Put big or medium-sized portions in correct rack position under the grill heater for grilling.
- Set the temperature to maximum level.
- Turn the food after half of the grilling time.

7. **Full grill**

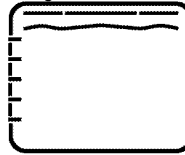

Large grill at the ceiling of the oven is in operation. It is suitable for grilling large amount of meat.

- Put big or medium-sized portions in correct rack position under the grill heater for grilling.
- Set the temperature to maximum level.
- Turn the food after half of the grilling time.

8. **Grill**

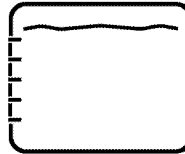

Small grill at the ceiling of the oven is in operation. Suitable for grilling and gratin dishes.

- Put small or medium-sized portions in correct shelf position under the grill heater for grilling.
- Set the temperature to maximum level.
- Turn the food after half of the grilling time.

9. **Eco Fan Heating**

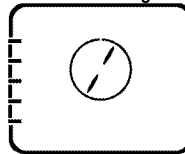

To save power, you can use this function instead of the cooking operations that you would perform by using Fan Heating at 160-220°C temperature range. But, the cooking time will increase a little bit.

Cooking times related to this function are indicated in 'Eco Fan Heating' table.

10. **Bottom heating**

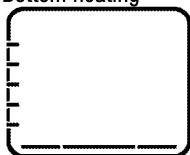

Only bottom heating is in operation. It is suitable for pizza and for subsequent browning of food from the bottom.

11. **Keep warm**

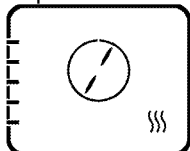

Used for keeping food at a temperature ready for serving for a long period of time.

12. **Operating with fan**

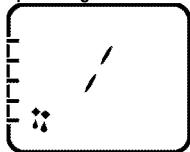

The oven is not heated. Only the fan (in the rear wall) is in operation. Suitable for thawing frozen granular food slowly at room temperature and cooling down the cooked food.

13. **Pyrolysis - economy mode**

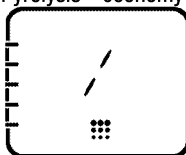

This function allows the oven to clean itself at a high temperature. It is recommended for lightly soiled ovens. Read the description in the cleaning section to use this function see, *page 29*.

14. **Pyrolysis**

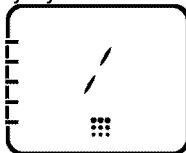

This function allows the oven to clean itself at a high temperature. Read the description in the cleaning section to use this function see, *page 29*.

15. **Easy steam cleaning**
(This feature is optional. It may not exist on your product.)

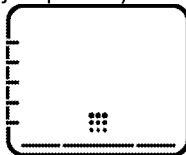

This function enables the dirt (having waited not for too long) in the oven to get soft and be cleaned easily. Please see "Cleaning - easy steam cleaning" section for easy steam cleaning.

How to operate the oven control unit

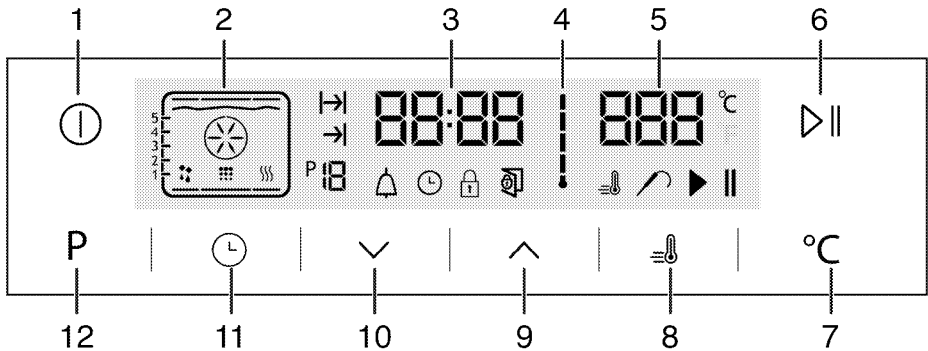

- 1 ON/OFF key
- 2 Function display
- 3 Current time indicator field
- 4 Oven Inner Temperature symbol
- 5 Temperature indicator field
- 6 Start/stop cooking key
- 7 Temperature setting key
- 8 Booster symbol (rapid pre-heating)
- 9 Plus key
- 10 Minus key
- 11 Adjustment key
- 12 Return Key to function display

- : Cooking Time symbol
- : End of Cooking Time symbol
- : Function number
- : Alarm symbol
- : Clock symbol
- : Keylock symbol
- : Open door symbol
- : Booster symbol (rapid pre-heating)
- : Meat Probe symbol
- : Cooking pause symbol
- : Cooking starting symbol

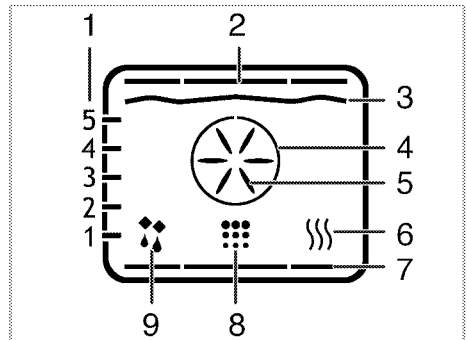

- 1 Shelf positions
- 2 Top heater
- 3 Grill heater
- 4 Boost heater
- 5 Boost fan
- 6 Keep warm
- 7 Bottom heater
- 8 Cleaning position
- 9 Operating with fan position

Functions vary depending on the product model!

Function table:

Function table indicates the operating functions that can be used in the oven and their respective maximum and minimum temperatures.

Function table	Recommended temperature (°C)	Temperature range (°C)
Top and bottom heating	200	40-280
Fan supported bottom/top heating	175	40-280
Fan assisted cooking	180	40-280
Surf	180	40-280
"3D" function	205	40-280
Pizza function	210	40-280
Fan assisted large grill	200	40-280

Full grill	280	40-280
Low grill	280	40-280
Eco Fan Heating	180	160-220
Bottom heating	180	40-220
Warm keeping	60	40-100

 Maximum adjustable cooking time in modes except warm keeping is limited with 6 hours due to safety reasons. Program will be cancelled in case of power failure. You must reprogram the oven.

 While making any adjustment, related symbols on the clock will flash.

 Current time cannot be set while the oven is operating in any function, or if semi-automatic or full automatic programming is made on the oven.

 Even if the oven is off, oven lamp lights up when the oven door is opened.

How to operate the oven

1. Touch the  key for approx. 2 seconds to open the oven.

» First operating function appears on display after the oven turns on. When the display is in this mode, cooking time, the end of cooking time and Booster (quick heating) function can be set.

 Oven will switch off automatically within 20 seconds if no oven setting is made on this screen.

Manual cooking by selecting temperature and operating function

You can do cooking by selecting temperature and operating function specific to your meal, manually controlling without setting the cooking duration.

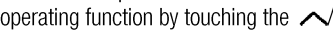
1. First operating function appears on display after touching  button to open the oven.
2. Select the operating function by touching the  keys.



3. If you desire to change the temperature that is recommended for operating function, enable the temperature field by touching  button.

»  symbol flashes.



4. Set the desired temperature touching  keys.

5. Confirm the temperature setting by touching  key.

6. Put your dish into the oven.

7. Touch   key to start cooking if temperature and operating function are appropriate.  symbol appears on display.

» Your oven will readily start operating in the selected function and will increase the inner temperature to the set temperature. Each grades of the inner temperature symbol will be lit as inner temperature reaches to the set temperature. Additional active heaters and recommended tray position appear in the Function display.

8. The oven does not turn off automatically due to the manual cooking without setting the cooking time. You can finish cooking by touching   key once again.

» The oven finishes the cooking and  symbol appears on display.

9. Touch the  button for approx. 2 seconds to close the oven.

Cooking by setting the cooking time;

You can ensure that the oven turns off by selecting temperature and operating function specific to your meal and setting the cooking time, manually controlling without setting the cooking duration.

1. First operating function appears on display after touching  button to open the oven.

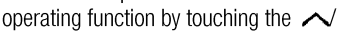
2. Select the operating function by touching the  keys.



3. If you desire to change the temperature that is recommended for operating function, enable the temperature field by touching  button.

»  symbol flashes.

4. Set the desired temperature touching  keys.



5. Confirm the temperature setting by touching  key.

6. Touch  until  symbol appears on display for cooking time.

7. Set the cooking time by touching  keys and confirm the setting by touching  key.

» Once the Cooking Time is set,  symbol will appear on display continuously.

8. Put your dish into the oven.

9. Touch   key to start cooking if temperature, operating function and cooking time are appropriate.  symbol appears on display.

» The oven will be heated up to the set temperature and will maintain this temperature until the end of the cooking time you selected.

» Your oven will readily start operating in the selected function and will increase the inner temperature to the

set temperature. It maintains this temperature until the end of the set cooking time. Each grades of the inner temperature symbol will be lit as inner temperature reaches to the set temperature. Additional active heaters and recommended tray position appear in the Function display.

10. After the cooking process is completed, "End" appears on the display and the alarm sounds.

11. Touch any key to silence the alarm.

» Alarm stops and the oven finishes operating automatically.

Setting the the end of cooking time to a later time;

You can ensure that the oven runs and turns off automatically by setting temperature and operating function specific to your meal, the cooking time and end of cooking to a later time, manually controlling without setting the cooking duration.

1. First operating function appears on display after touching  button to open the oven.

2. Select the operating function by touching the  keys.



3. If you desire to change the temperature that is recommended for operating function, enable the temperature field by touching  button.

»  symbol flashes.



4. Set the desired temperature touching  keys.



5. Confirm the temperature setting by touching  key.

6. Touch  until  symbol appears on display for cooking time.

7. Set the cooking time by touching  keys and confirm the setting by touching  key.



» Once the Cooking Time is set,  symbol will appear on display continuously.

8. Touch  until  symbol appears on display for the end of cooking time.

9. Set the cooking time by touching  buttons and confirm the setting by touching  key.

» Once the the end of cooking time is set,  symbol will appear on display continuously.

10. Put your dish into the oven.

11. Touch   key to start cooking if temperature, operating function, cooking time and the end of cooking time are appropriate.  symbol appears on display.

» Oven timer automatically calculates the startup time for cooking by deducting the cooking time from the end of cooking time you have set. Selected operation

mode is activated when the startup time of cooking has come and the oven is heated up to the set temperature. It maintains this temperature until the end of the set cooking time. Each grades of the inner temperature symbol will be lit as inner temperature reaches to the set temperature. Additional active heaters and recommended tray position appear in the Function display.

12. After the cooking process is completed, "End" appears on the display and the alarm sounds.

13. Touch any key to silence the alarm.

» Alarm stops and the oven finishes operating automatically.



If you want to cancel only cooking time or cooking time plus the end of cooking time after you have set them, you need to reset the cooking time.

Setting the booster (Quick Pre-heating)

Use Booster (Rapid Pre-heating) function to make the oven reach the desired temperature faster.





Booster cannot be selected in defrosting, eco fan heating ,keeping warm and cleaning positions. Booster settings will be cancelled in case of power outage.

1. Touch  key after setting the temperature, operating function, cooking time and the end of cooking time.

»  symbol appears continuously and booster (rapid pre-heating) setting is enabled.

» Booster symbol disappears as soon as the oven reaches the desired temperature and oven resumes operating in the function it was in before the Booster function.

2. Touch the  key again in order to cancel booster function.

»  symbol disappears and booster (rapid pre-heating) setting is disabled.

Switching off the electric oven

Touch  key to switch off the oven.



Activating the keylock

You can prevent oven from being intervened with by activating the key lock function.

1. Touch  until  symbol appears on display.





» "OFF" will appear on the display.

2. Press  to activate the key lock.

» Once the key lock is activated, "On" appears on the display and the  symbol remains lit. Confirm by touching .

 Oven keys are not functional when the key lock is activated. Key lock will not be cancelled in case of power failure.



To deactivate the keylock,

1. Touch  until  symbol appears on display.
» "On" will appear on the display.
2. Disable the key lock by pressing the  key.
» "OFF" will appear once the key lock is deactivated.
Confirm by touching .





 Oven keys are not functional when the Key lock function is activated. Key lock settings will not be cancelled in case of power outage.

Setting the alarm clock

You can use the timer of the product for any warning or reminder apart from the cooking program. The alarm clock has no influence on the functions of the oven. It is only used as a warning. For example, this is useful when you want to turn food in the oven at a certain point of time. Timer will give an audio warning at the end of the set time.

1. Touch  until  symbol appears on display.



 Maximum alarm time can be 23 hours and 59 minutes.

2. Set the alarm duration by using  /  keys.
»  symbol will remain lit and the alarm time will appear on the display once the alarm time is set.
3. At the end of the alarm time,  symbol starts flashing and the audio warning is heard.

Turning off the alarm





1. Audio warning sounds for 2 minutes. To stop the audio warning, just press any key.
» Audio warning will be silenced and current time will be displayed.

Cancelling the alarm;

1. Touch  until  symbol appears on display in order to cancel the alarm.
2. Press and hold  key until "00:00" is displayed.





 Alarm time will be displayed. If the alarm time and cooking time are set concurrently, shortest time will be displayed.

Changing the time of the day





1. Touch  key in short intervals until  symbol appears on display.
2. Touch  /  keys to set the hour.
3. Confirm the setting by touching  symbol and wait for 4 seconds without touching any keys to confirm.



 Current time settings are canceled in case of power failure. It needs to be readjusted. Current time can not be changed when any of the oven functions is in use.

Adjusting the volume

1. While the oven is in Standby mode, touch  key in short intervals until 'VOL' appears on display.
2. Press  /  keys to set one of LO, L1 or L2 tones.
3. Press  key or wait for 4 seconds without touching any keys to confirm the setting

Adjusting the Eco lamp setting

1. While the oven is in Standby mode, touch  key in short intervals until 'LP' appears on display.
2. Press  /  keys to set On or ECO option.
3. Press  key or wait for 4 seconds without touching any keys to confirm the setting
4. When set to ON; while the oven door is open in Standby mode and during operation the lamp is turned ON continuously.
5. When set to ECO; while the oven door is open in Standby mode and during operation the lamp is turned ON and then turned OFF after 15 seconds.

If any key is touched during operation (excluding  and  keys) the lamp is turned ON and then turned OFF after 15 seconds.

Cooking times table



The timings in this chart are meant as a guide. Timings may vary due to temperature of food, thickness, type and your own preference of cooking.

Baking and roasting



1st rack of the oven is the **bottom** rack.

Dish	Cooking level number	Operating Mode (see page 18-20)	Rack position	Temperature (°C)	Cooking time (approx. in min.)
Cakes in tray*	One level		3	175	25 ... 35 25 ... 30
Cakes in mould*	One level		2	180	50 ... 60
Cakes in cooking paper*	One level		3	165	20 ... 30 25 ... 30
	2 levels		1 - 3	165	35 ... 45
	3 levels		1 - 3 - 5	165	40 ... 55
Sponge cake*	One level		3	200	8 ... 12
	2 levels		1 - 5	200	15 ... 20
	3 levels		1 - 3 - 5	175	20 ... 30
Cookies*	One level		3	175	25 ... 30
	2 levels		1 - 3	165	35 ... 45
	3 levels		1 - 3 - 5	165	35 ... 45
Dough pastry*	One level		2	200	30 ... 40
	2 levels		1 - 5	200	45 ... 55
	3 levels		1 - 3 - 5	200	45 ... 55
Rich pastry*	One level		2	200	25 ... 35
	2 levels		1 - 3	200	35 ... 45
	3 levels		1 - 3 - 5	200	35 ... 45
Leaven*	One level		2	200	35 ... 45
Lasagna*	One level		2 - 3	200	30 ... 40
Pizza*	One level		2	200 ... 220	15 ... 20
	One level		3	200	10 ... 15
Beef steak (whole) / Roast	One level		3	25 min. 250/max then 180 ... 190	100 ... 120
Leg of Lamb (casserole)	One level		3	25 min. 250/max then 190	70 ... 90
	One level		3	25 min. 250/max then 190	60 ... 80
Roasted chicken	One level		2	15 min. 250/max then 180 ... 190	60 ... 70
	One level		2	15 min. 250/max then 180 ... 190	55 ... 65
Turkey (5.5 kg)	One level		1	25 min. 250/max then 180 ... 190	150 ... 210
	One level		1	25 min. 250/max then 180 ... 190	150 ... 210
Fish	One level		3	200	20 ... 30
	One level		3	200	20 ... 30

When cooking with 2 trays at the same time, place the deeper tray on the upper rack and the other one on the lower rack.

* It is suggested to perform preheating for all foods.

Eco Fan Heating



Do not change the cooking temperature after cooking starts in Eco Fan Heating mode.



Do not open the door during cooking in the Eco Fan Heating mode.

Dish	Cooking level number	Operating Mode (see page 18-20)	Rack position	Temperature (°C)	Cooking time (approx. in min.)
Cakes in cooking paper	One level		2	200	35 ... 40
Cookies	One level		2	200	30 ... 35
Dough pastry	One level		2	200	40 ... 45
Rich pastry	One level		2	200	40 ... 45

Tips for baking cake

- If the cake is too dry, increase the temperature by 10°C and decrease the cooking time.
- If the cake is wet, use less liquid or lower the temperature by 10°C.
- If the cake is too dark on top, place it on a lower rack, lower the temperature and increase the cooking time.
- If cooked well on the inside but sticky on the outside use less liquid, lower the temperature and increase the cooking time.

Tips for baking pastry

- If the pastry is too dry, increase the temperature by 10°C and decrease the cooking time. Dampen the layers of dough with a sauce composed of milk, oil, egg and yoghurt.
- If the pastry takes too long to bake, pay care that the thickness of the pastry you have prepared does not exceed the depth of the tray.
- If the upper side of the pastry gets browned, but the lower part is not cooked, make sure that the amount of sauce you have used for the pastry is not too much at the bottom of the pastry. Try to scatter the sauce equally between the dough layers and on the top of pastry for an even browning.



Cook the pastry in accordance with the mode and temperature given in the cooking table. If the bottom part is still not browned enough, place it on one lower rack next time.

For the best cooking results (Surf function):

- You can cook foods made of dense dough such as buns, cake in paper, cookies or biscuits simultaneously in 1, 2 or 3 trays thanks to the homogenous heat distribution ensured by this function.
- You may cook wet dough foods such as apple pie and tart in tray simultaneously in 2 trays.
- Cooking large amount of foods containing much liquid or yeasted dough in a single tray will improve the cooking result. More homogenous cooking is obtained in large volume foods which are rising as the hot air comes from the side walls as well, which is a function not contained in conventional ovens.
- Time and energy can be saved and perfect cooking results can be obtained thanks to the multi-tray cooking feature of this function.

Tips for cooking vegetables

- If the vegetable dish runs out of juice and gets too dry, cook it in a pan with a lid instead of a tray. Closed vessels will preserve the juice of the dish.
- If a vegetable dish does not get cooked, boil the vegetables beforehand or prepare them like canned food and put in the oven.









How to operate the grill





WARNING

Close oven door during grilling.
Hot surfaces may cause burns!

Switching on the grill

1. First operating function appears on display after touching  button to open the oven.
2. Touch  to select the desired grill function.
3. If you desire to change the temperature that is recommended for operating function, enable the temperature field by touching  button.
»  symbol flashes.
4. Set the desired temperature touching  keys.
5. Confirm the temperature setting by touching  key.
6. Touch   key to start grilling if temperature and operating function are appropriate.  symbol appears on display.

» Your oven will readily start operating in the selected function and will increase the inner temperature to the set temperature. Each grades of the inner temperature symbol will be lit as inner temperature reaches to the set temperature. Additional active heaters and recommended tray position appear in the Function display.

7. You can finish grilling by touching   button once again.

» The oven finishes grilling and  symbol appears on display.

Switching off the grill

1. Touch the  button for approx. 2 seconds to close the oven.



Foods that are not suitable for grilling carry the risk of fire. Only grill food which is suitable for intensive grilling heat.

Do not place the food too far in the back of the grill. This is the hottest area and fatty food may catch fire.

Cooking times table for grilling

Grilling with electric grill

Food	Insertion level	Grilling time (approx.)
Fish	4..5	20..25 min. [#]
Sliced chicken	4..5	25..35 min.
Lamb chops	4..5	20..25 min.
Roast beef	4..5	25..30 min. [#]
Veal chops	4..5	25..30 min. [#]
Toast bread	4	1..2 min.

[#] depending on thickness

6 Maintenance and care

General information

Service life of the product will extend and the possibility of problems will decrease if the product is cleaned at regular intervals.

**DANGER:**

Disconnect the product from mains supply before starting maintenance and cleaning works.
There is the risk of electric shock!

**DANGER:**

Allow the product to cool down before you clean it.
Hot surfaces may cause burns!

- Clean the product thoroughly after each use. In this way it will be possible to remove cooking residues more easily, thus avoiding these from burning the next time the appliance is used.
- No special cleaning agents are required for cleaning the product. Use warm water with washing liquid, a soft cloth or sponge to clean the product and wipe it with a dry cloth.
- Always ensure any excess liquid is thoroughly wiped off after cleaning and any spillage is immediately wiped dry.
- Do not use cleaning agents that contain acid or chloride to clean the stainless or inox surfaces and the handle. Use a soft cloth with a liquid detergent (not abrasive) to wipe those parts clean, paying attention to sweep in one direction.



The surface might get damaged by some detergents or cleaning materials.
Do not use aggressive detergents, cleaning powders/creams or any sharp objects during cleaning.
Do not use harsh abrasive cleaners or sharp metal scrapers to clean the oven door glass since they can scratch the surface, which may result in shattering of the glass.



Do not use steam cleaners to clean the appliance as this may cause an electric shock.

Cleaning the control panel

Clean the control panel and knobs with a damp cloth and wipe them dry.



Do not remove the control buttons/knobs to clean the control panel.
Control panel may get damaged!

Cleaning the oven

To clean the side wall

(This feature is optional. It may not exist on your product.)

1. Remove the front section of the side rack by pulling it in the opposite direction of the side wall.
2. Remove the side rack completely by pulling it towards you.

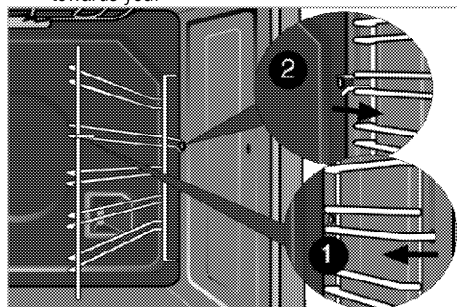

(If your product is equipped with "Surf" function)

1. Remove pin (1) of the side rack by pulling it in the direction of arrow with the side wall it is mounted.

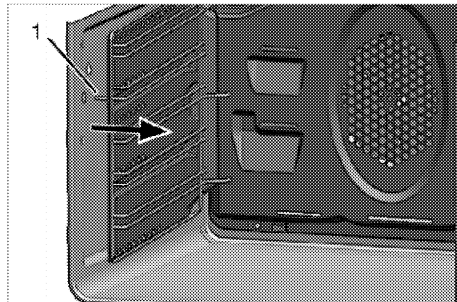

2. Remove the side rack and side wall completely by pulling it towards you.
3. Remove the side rack from the holes (2) on the oven wall by pulling.



The number of holes behind the side wall and the size of the wire rack may change depending on the product model.

4. To clean the side rack and side wall, use warm water with washing liquid, a soft cloth or sponge to clean the product and wipe it with a dry cloth.
5. Place side rack by pulling to holes (2) on the back of side wall.

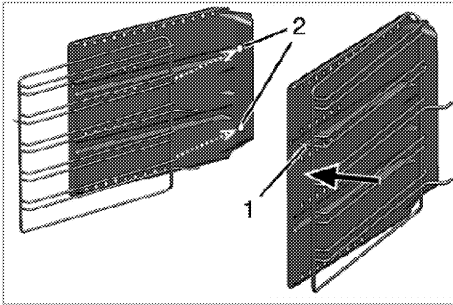

i If you have the flexi telescopic feature of your product; there is one hole on the back surf side wall. Place side rack by pulling to hole.

6. Lock side rack to side wall by pulling pin (1) of side rack in the direction of arrow.
7. Place side rack and side wall assembly to its place by pulling pins (3) to holes on the back wall as shown in figure.

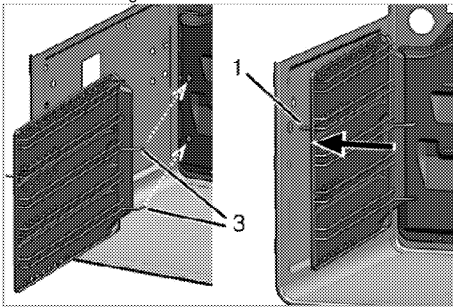

8. Place pin (1) at side rack to its place as shown in figure.

i Be sure that side rack and side wall has been placed properly.

Catalytic walls

(This feature is optional. It may not exist on your product.)

The inner side walls (A) and/or the rear wall (B) of your product may be coated with catalytic enamel. Catalytic walls have a light matte colour and a porous surface. Catalytic walls of the oven should not be cleaned. Porous surfaces of the catalytic walls are automatically cleaned by absorbing and converting the spilled oil (steam and carbon dioxide).

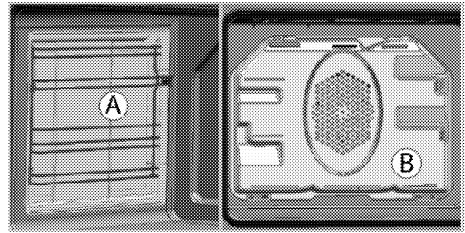

Easy Steam Cleaning

(This feature is optional. It may not exist on your product.)

It ensures easy cleaning because the dirt (having waited not for too long) is softened with the steam that forms inside the oven and the water drops condensing on the inner surfaces of the oven.

1. Remove all accessories inside the oven.
2. Pour 500 ml of water into the oven tray and place the tray at the 2nd rack of the oven.

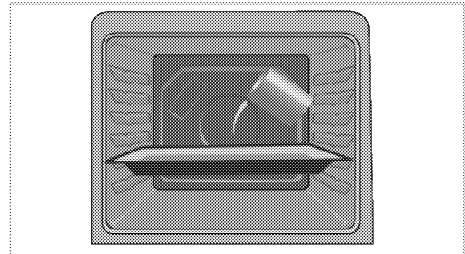

3. Select easy steam cleaning function. Cleaning duration will appear on the screen and it cannot be changed. You can set the end time for this cleaning function.
4. Open the door and wipe the inner surfaces of the oven with a damp sponge or cloth.
5. Use warm water with washing liquid, a soft cloth or sponge to clean the persistent dirt and wipe it with a dry cloth.

Pyrolytic self-cleaning



DANGER:

Hot surfaces cause burns!

Do not touch the product during self cleaning step and keep children away from it. Keep at least 30 minutes before removing the remnants.

The oven is equipped with pyrolytic self-cleaning. The oven is heated to approx. 430-480 °C and existing dirt is burned to ashes. A strong smoke development may arise. Provide for good ventilation. The pyrolysis should be used after approx. every 10th oven usage.

1. Remove all accessories from the oven. In models with side rack; do not forget to take out the side racks.

If your product is equipped with a pyro proof accessory (Resilient against self-cleaning at high temperatures), you do not need to remove these accessories from the oven.

2. Before the cleaning cycle, remove dirt from exterior surfaces and oven interior with a damp cloth.



Do not clean the door gasket. Fiberglass gasket is highly sensitive and can get damaged easily. In case of a damage on the oven door gasket, replace with the new one from the authorised service.

3. "Pyrolysis"  Select the pyrolytic function (self-cleaning).

 **eco** It is advised to use economic cleaning function if the oven does not have too much dirt.

If this function is used for heavy dirt, there won't be sufficient cleaning. For such cases, pyrolysis function

 should be applied after economic cleaning

 **eco** cycle finished.

The self-cleaning time appears in the display. This duration can not be adjusted.

The end of self cleaning cycle can be adjusted.

4. Oven door cannot be opened and lock symbol



appears on the time display during self cleaning. It remains locked for a while after the pyrolysis function ends. Do not force the door lock

with handle until lock symbol  disappears.

5. After a clean cycle, remove soil deposits with vinegar water.

Clean oven door

To clean the oven door, use warm water with washing liquid, a soft cloth or sponge to clean the product and wipe it with a dry cloth.



Don't use any harsh abrasive cleaners or sharp metal scrapers for cleaning the oven door. They could scratch the surface and destroy the glass.

Removing the oven door

1. Open the front door (1).
2. Open the clips at the hinge housing (2) on the right and left hand sides of the front door by pressing them down as illustrated in the figure.

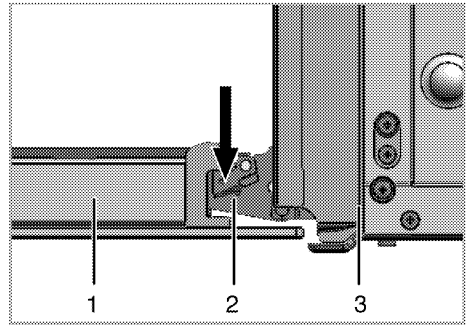

- 1 Front door
- 2 Hinge
- 3 Oven

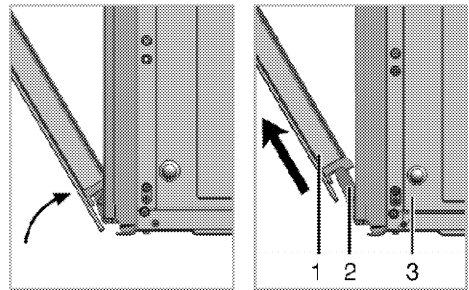

3. Move the front door to half-way.
4. Remove the front door by pulling it upwards to release it from the right and left hinges.



Steps carried out during removing process should be performed in reverse order to install the door. Do not forget to close the clips at the hinge housing when reinstalling the door.

Removing the door inner glass

(This feature is optional. It may not exist on your product.)

The inner glass panel of the oven door can be removed for cleaning.

1. Open the oven door.

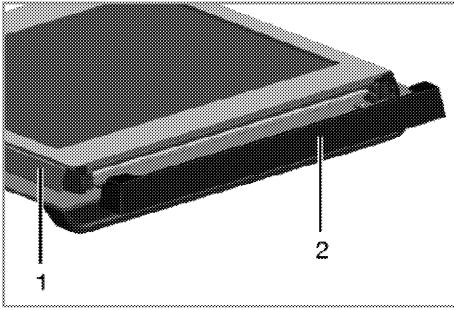

- 1 Frame
- 2 Plastic part
2. Pull towards yourself and remove the plastic part installed to upper section of the front door.

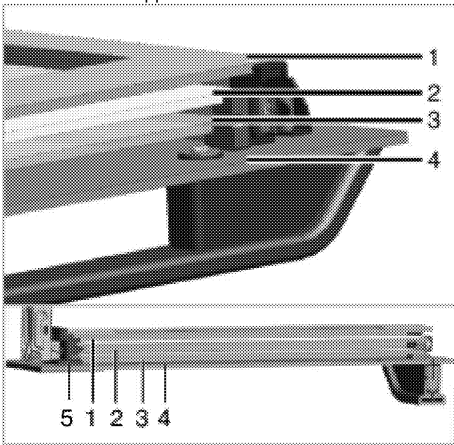

- 1 Innermost glass panel
- 2 Second inner glass panel
- 3 Third inner glass panel
- 4 Outer glass panel
- 5 Plastic glass panel slot-Lower
3. As illustrated in figure, raise the innermost glass panel slightly in direction **A** and pull it out in direction **B**.

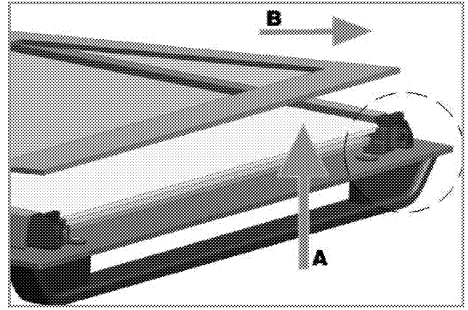

4. Repeat the same procedure to remove the second and third glass panels.

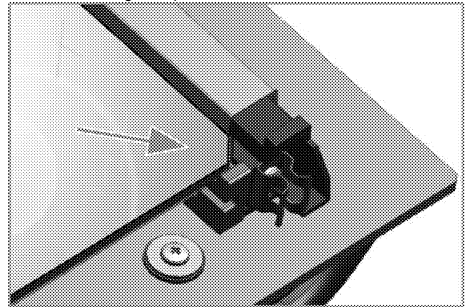

The first step to regroup the door is reinstalling second and third inner glass panels (2, 3).

As illustrated in figure, place the chamfered corner of the glass panel so that it will rest in the chamfered corner of the plastic slot.

Inserted as the second and third inner glass is important. Aluminum slatted glass 2 must be installed in the glass.

When installing the innermost glass panel (1), make sure that the printed side of the panel faces towards the second glass panel.

It is important to seat lower corners of all inner glass panels into the lower plastic slots (5). Push the plastic part towards the frame until you hear a "click".

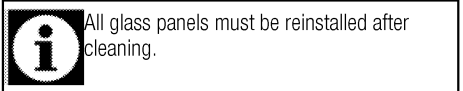

Replacing the oven lamp



DANGER:

Before replacing the oven lamp, make sure that the product is disconnected from mains and cooled down in order to avoid the risk of an electrical shock.

Hot surfaces may cause burns!



The oven lamp is a special electric light bulb that can resist up to 300 °C. See *Technical specifications, page 11* for details. Oven lamps can be obtained from Authorised Service Agents or technician with licence.



Position of lamp might vary from the figure.



The lamp used in this appliance is not suitable for household room illumination. The intended purpose of this lamp is to assist the user to see foodstuffs.



The lamps used in this appliance have to withstand extreme physical conditions such as temperatures above 50 °C.

If your oven is equipped with a round lamp:

1. Disconnect the product from mains.
2. Turn the glass cover counter clockwise to remove it.

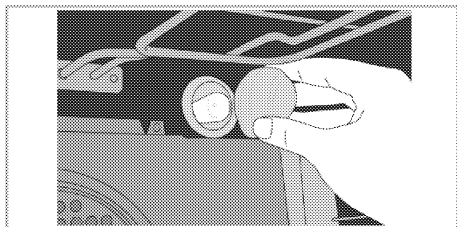

3. If your oven lamp is of type (A) shown in the figure below, remove it by rotating as shown and replace it. If it is of type (B), pull and remove it as shown in the figure and replace it.

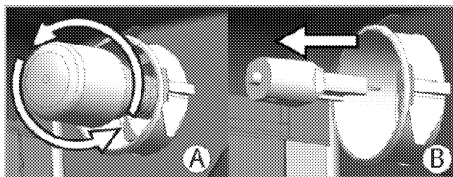

4. Install the glass cover.

If your oven is equipped with a square lamp:

1. Disconnect the product from mains.
2. Remove the wire racks as described. See *Cleaning the oven, page 28*.

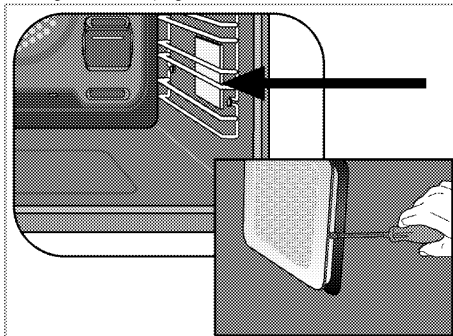

3. Remove the protective glass cover with a screwdriver.
4. If your oven lamp is of type (A) shown in the figure below, remove it by rotating as shown and replace it. If it is of type (B), pull and remove it as shown in the figure and replace it.

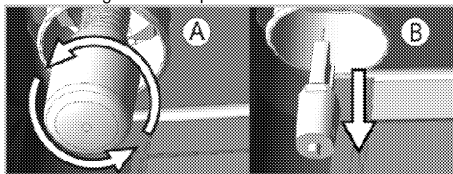

5. Install the glass cover and then the wire racks.

7 Troubleshooting

Oven emits steam when it is in use.

- It is normal that steam escapes during operation. >>> *This is not a fault.*

Product emits metal noises while heating and cooling.

- When the metal parts are heated, they may expand and cause noise. >>> *This is not a fault.*

Product does not operate.

- The mains fuse is defective or has tripped. >>> *Check fuses in the fuse box. If necessary, replace or reset them.*
- Product is not plugged into the (grounded) socket. >>> *Check the plug connection.*

Oven light does not work.

- Oven lamp is defective. >>> *Replace oven lamp.*
- Power is cut. >>> *Check if there is power. Check the fuses in the fuse box. If necessary, replace or reset the fuses.*

Oven does not heat.

- Function and/or Temperature are not set. >>> *Set the function and the temperature with the Function and/or Temperature knob/key.*
- Power is cut. >>> *Check if there is power. Check the fuses in the fuse box. If necessary, replace or reset the fuses.*



Consult the Authorised Service Agent or technician with licence or the dealer where you have purchased the product if you can not remedy the trouble although you have implemented the instructions in this section. Never attempt to repair a defective product yourself.

