

# Bissell®

## PROHEAT® 2X REVOLUTION® PET

USER GUIDE  
2066F

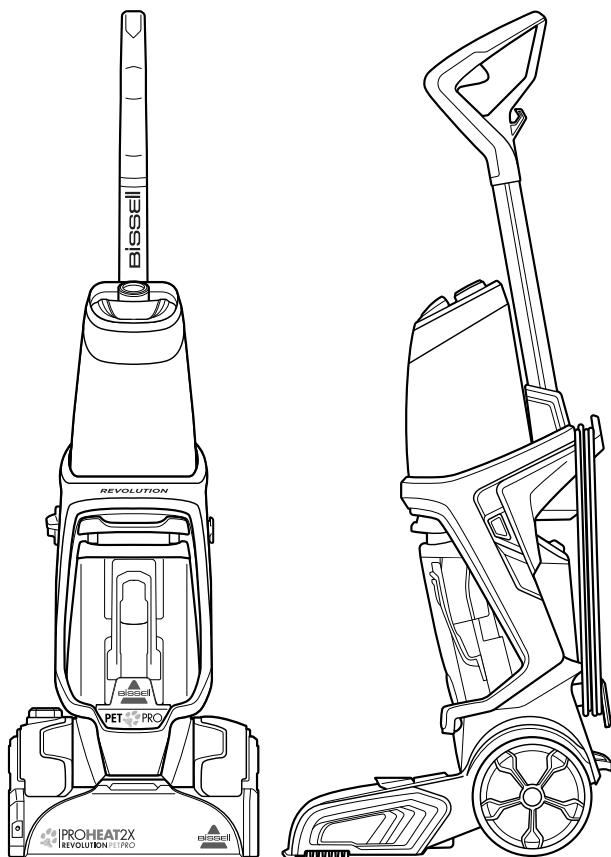

# IMPORTANT SAFETY INSTRUCTIONS

## READ ALL INSTRUCTIONS BEFORE USING YOUR APPLIANCE.

When using an electrical appliance, basic precautions should be observed, including the following:



## WARNING

**TO REDUCE THE RISK OF FIRE, ELECTRIC SHOCK OR INJURY:**

- » This appliance is not intended for use by persons (including children) with reduced physical, sensory or mental capabilities, or lack of experience and knowledge, unless they have been given supervision or instruction concerning use of the appliance by a person responsible for their safety.
- » Children should be supervised to ensure that they do not play with the appliance.
- » Unplug from electrical socket when not in use, before cleaning, maintaining, or servicing the appliance, and if your appliance has an accessory tool with a moving brush, before connecting or disconnecting the tool.
- » Do not immerse in water or liquid.
- » Keep hair, loose clothing, fingers, and all parts of body away from openings and moving parts of the appliance and its accessories.
- » If the supply cable is damaged, it must be replaced by the manufacturer, its service agent or similarly qualified person in order to avoid a hazard.
- » Do not run appliance over cable.
- » Do not use with damaged cable or plug.
- » Do not pull or carry by cable, use cable as a handle, close door on cable, or pull cable around sharp edges or corners.
- » Keep cable away from heated surfaces.
- » If the appliance has a handheld accessory like a pet brush, motor driven head, etc., the user shall avoid entrapment.
- » Do not leave appliance when plugged in.
- » To unplug, grasp the plug, not the cable.
- » Do not handle plug or appliance with wet hands.
- » Turn OFF all controls before unplugging.
- » Plastic film can be dangerous. To avoid danger of suffocation, keep away from children.
- » Use only as described in this user guide.
- » Use only manufacturer's recommended attachments.
- » If appliance is not working as it should, has been dropped, damaged, left outdoors, or dropped into water; do not attempt to operate it and have it repaired at an authorised service center.
- » Do not put any object into openings.
- » Do not use with any opening blocked; keep free of dust, lint, hair, and anything that may reduce air flow.
- » Use extra care when cleaning on stairs.
- » Do not use to pick up flammable or combustible liquids, such as petroleum, or use in areas where they may be present.
- » Do not pick up toxic material (chlorine bleach, ammonia, drain cleaner, etc.).
- » Do not use appliance in an enclosed space filled with vapours given off by oil-based paint, paint thinner, some moth-proofing substances, flammable dust, or other explosive or toxic vapours.
- » Do not pick up hard or sharp objects such as glass, nails, screws, coins, etc.
- » Do not pick up anything that is burning or smoking, such as cigarettes, matches or hot ashes.
- » Do not use without filters in place.
- » Use indoors only.
- » Always connect to a properly earthed electrical socket. Do not modify earthed plug.
- » Liquid must not be directed towards equipment containing electrical components.
- » Do not immerse. Use only on surfaces moistened by the cleaning process. Use only BISSELL cleaning products intended for use with this machine.
- » Always install float before any wet pick-up operation.
- » Use only the type and amount of liquids specified under the operations section of this guide.
- » Use only on carpet moistened by cleaning process.

## SAVE THESE INSTRUCTIONS

ORIGINAL INSTRUCTIONS. FOR OPERATION ON A 220-240 VOLT A.C. 50-60 HZ POWER SUPPLY ONLY. THIS MODEL IS FOR HOUSEHOLD USE ONLY.

### IMPORTANT INFORMATION

- » Keep appliance on a level surface.
- » If your appliance has a motorised Brush Roll, do not leave machine running in the same spot without the handle fully upright.
- » To reduce the risk of a leaking condition, do not store machine where freezing may occur. Damage to internal components may result.

# Thanks for buying a BISSELL® carpet washer!

We love to clean and we're excited to share one of our innovative products with you. We want your carpet washer to work like new for the years to come, so this guide has tips on how to use, maintain and, if there's a problem, troubleshoot.

Your machine needs a little assembly before getting to work, so flip to the "Assembly" section and let's get started!

## What's In The Box?

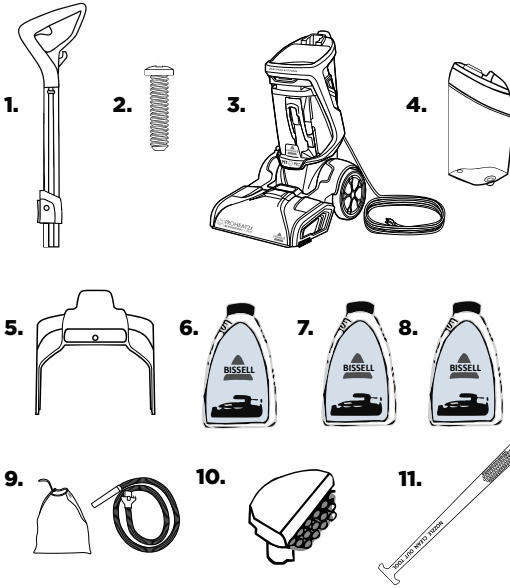

1. Upper Handle
2. (1) Screw attached to Upper Handle
3. Base with Dirty Water Tank
4. Clean Water Tank
5. Carry Handle
6. BISSELL Wash & Protect Pro
7. BISSELL Wash & Remove Antibacterial
8. BISSELL Oxy Boost Formula
9. Accessory Bag & Hose
10. 3 Specialized Tools
11. Nozzle Clean Out Tool

Safety Instructions.....2

Product View.....4

Assembly.....5

Cleaning Formulas.....6

Operations.....6-10

Maintenance & Care.....11-14

Troubleshooting.....15

Guarantee.....16

Service.....16

Contact Information.....16

# Product View

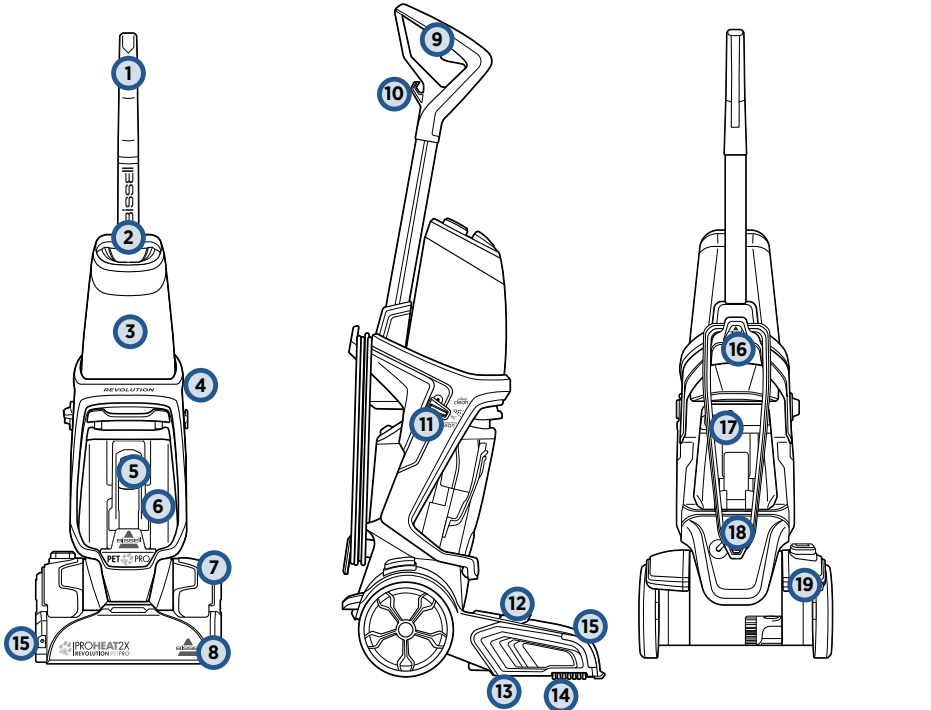

- |  |                            |  |
|--|----------------------------|--|
| 1 Upper Handle                             | 7 Belt Access Door         | 14 EdgeSweep Brushes                   |
| 2 Easy Fill/Formula Cap                    | 8 Foot                     | 15 CleanShot                           |
| 3 Clean Water Tank<br>(3.7 Litre Capacity) | 9 Spray Trigger            | 16 Carry Handle                        |
| 4 Power Switch                             | 10 Power Cable Clip        | 17 Rubber Tab<br>(on Dirty Water Tank) |
| 5 Float Stack                              | 11 Cleaning Mode Switch    | 18 Cable Quick Release                 |
| 6 Dirty Water Tank                         | 12 Accessory Hose Door     | 19 Recline Pedal                       |
|  | 13 Belt/Brush Access Plate |  |

# Helpful Cleaning Tips

## Before Cleaning

- » Clean on a day with low humidity so carpet dries faster.
- » Consider moving furniture to another area.
- » Vacuum dirt and debris.
- » Pretreat stains with BISSELL® Pretreat.

## While Cleaning

- » Dry strokes help carpet dry faster except when using Express Clean Mode or Wash & Remove + Antibacterial formula (follow directions exactly in those two cases).

## After Cleaning

- » Point portable fan at carpet. A dehumidifier may also help in drying.
- » In the winter, turn heat up a few degrees and in the summer, turn the air conditioning down.
- » On warm, dry days, opening the windows is an eco-friendly way to dry.
- » When carpet feels dry, return furniture and put wax paper or aluminum foil underneath. Remove after 3 hours.

# Assembly

## WARNING

Do not plug in your carpet cleaner until you are familiar with all instructions and operating procedures.

In step 3, you will need to use a Phillips-head screwdriver.

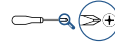

1

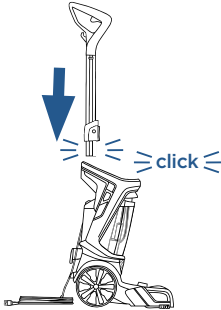

First, insert the Upper Handle at the top of the base until you hear a "click".

2

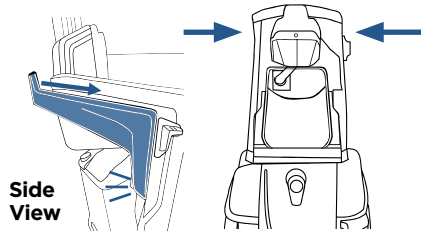

Next, align the Carry Handle with the slots on either side of the base (behind the Power Switch and Cleaning Mode Switch). The Carry Handle will "click" into place.

**IMPORTANT:** Do NOT put the Clean Water Tank on the machine until step 5.

3

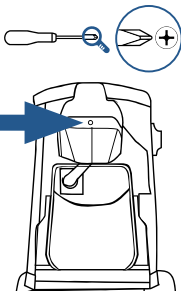

Using a Phillips-head screwdriver, secure the Carry Handle with the screw that's taped to the Upper Handle.

4

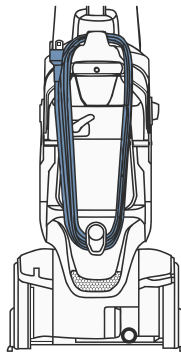

Wrap the cable around the Carry Handle and Cable Quick Release.

5

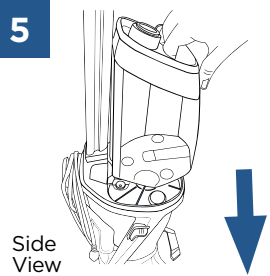

At the bottom of the Upper Handle, align the Clean Water Tank with the grooves and slide the tank into place.

# Cleaning Formulas



Keep plenty of BISSELL® formulas on hand so you can clean whenever it fits your schedule. Always use genuine BISSELL formulas in your machine. Other formulas may harm the machine and void the guarantee.

## Carpet Cleaning Formulas

Wash & Protect			Wash & Refresh
			
<b>Pro Stain &amp; Odour</b> Professional strength to remove extra tough stains and odours.	<b>Pet Stain &amp; Odour</b> Removes tough pet stains and odours.	<b>Stain &amp; Odour</b> Removes tough stains and odours.	<b>Ambipur Blossom &amp; Breeze</b> Powerful cleaning with a refreshing spring scent.
Wash & Remove		easy fill <sub>SYSTEM</sub>	
			
<b>Pro Pet Urine Eliminator + Oxy</b> Permanently removes stains and odors at the source with the power of Oxy.	<b>Allergen</b> Helps remove pet dander, pollen and dust mite waste allergens.	<b>Wash &amp; Remove + Antibacterial</b> Cleans and controls odor causing bacteria.	

## Pretreat

Pretreat spots and stains to improve carpet cleaning performance.

	
<b>Stain Pretreat</b> Loosens set-in stains & odours before carpet washing.	<b>Pet Stain Pretreat</b> Loosens tough pet stains & odours before carpet washing.

## Boost



Add Boost carpet cleaning formula enhancers to any formula to increase its effectiveness.

<b>Oxy Boost</b> Add to formula for permanent stain removal.

Certain trademarks used under license from The Procter & Gamble Company or its affiliates.

# Filling Your Clean Water Tank

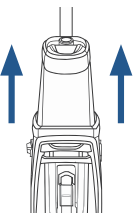
## Wash & Remove + Antibacterial Formula

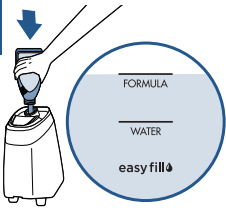
<b>1</b> 	<b>2</b> 	<b>3</b> 
<p>The Clean Water Tank is at the top of the machine. Lift the tank straight up to remove.</p>	<p>Unscrew the cap from the Clean Water Tank. Add warm tap water to the water fill line.</p>	<p><b>Included Trial-Size Antibacterial Formula:</b> Pour formula into the tank up to the Easy Fill line. Twist cap back on to tank.</p>

# Filling Your Clean Water Tank (cont.)

4

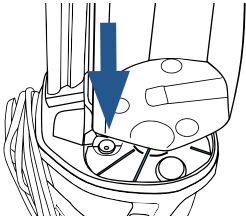

At the bottom of the Upper Handle, align the Clean Water Tank with the grooves and slide the tank into place.

## For Future Use with Full-Size Antibacterial Formula:

After filling the Clean Water Tank with warm tap water, twist the yellow tank cap back into place. Firmly insert the full-size formula bottle into the cap on the Clean Water Tank and squeeze until formula reaches the Easy Fill line.

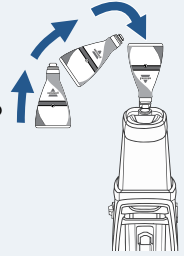

**NOTE:** Fill with warm (140°F/60°C MAX) tap water and add the appropriate BISSELL® formula. **DO NOT USE BOILING WATER. DO NOT HEAT WATER OR TANK IN MICROWAVE.** When using BISSELL Wash & Remove + Antibacterial formula: Only fill your Clean Water Tank with the recommended amount of water and formula to achieve anti-bacterial benefits.

## Cleaning Formulas

1

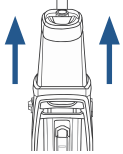

The Clean Water Tank is at the top of the machine. Lift the tank straight up to remove.

2

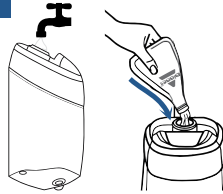

Unscrew the cap from the Clean Water Tank. Add warm tap water to the water fill line. Add desired formula to the formula fill line. After formula is added, secure the tank cap in place.

3

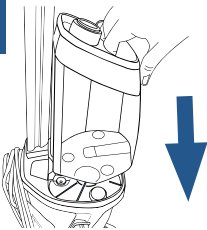

At the bottom of the Upper Handle, align the Clean Water Tank with the grooves and slide the tank into place.

**NOTE:** Fill with warm (140°F/60°C MAX) tap water and add the appropriate BISSELL® formula. **DO NOT USE BOILING WATER. DO NOT HEAT WATER OR TANK IN MICROWAVE.** Do not substitute BISSELL formula with other household cleaning products.



## Pour in more power with BISSELL Oxy Boost

- Fill tank with water and formula (Step 3 above).
- Add 60 mL of BISSELL Oxy Boost per 3.7 L of water.
- The ProHeat® 2X Revolution® has a 3.7-L Clean Water Tank.

**NOTICE:** Do not overwet carpet. Be careful not to run over loose objects or edges of area rugs. Stalling the brush may result in premature belt failure.

# Cleaning Your Carpet

1

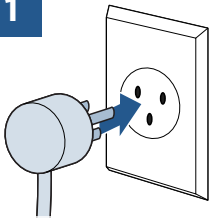

Plug into a properly earthed outlet.

2



## Select Cleaning Mode:

**Deep Clean:** Delivers a deep clean to your carpet. Dry Time: About 8 hours

**Express Clean:** Provides a lighter clean. Dry Time: About 30 minutes

\*Choose "Deep Clean" mode and use BISSELL® Wash & Remove + Antibacterial to deliver antibacterial benefits.

3

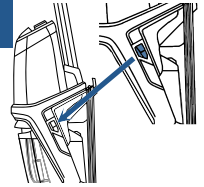

Press the Power Switch to turn the machine ON. To recline your machine for use, press the Recline Pedal with your foot.

4

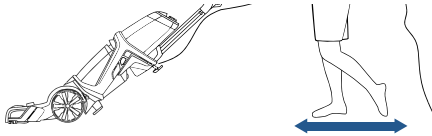

## Deep Clean Mode: Standard Cleaning

1. Press the Spray Trigger to apply solution while making 2 slow, wet passes (1 forward, 1 back).
2. Release the Spray Trigger.
3. Make 2 slow, dry passes (1 forward, 1 back) to suck up the dirty solution. **Do not hold down the trigger for this step.**

## Using BISSELL® Wash & Remove + Antibacterial Formula

1. Press the Spray Trigger to apply solution while making 3 slow, wet passes (1 forward, 1 back, and 1 forward again).
2. Release the trigger.
3. Make 1 slow, dry pass back to suck up the dirty solution. **Do not hold down the trigger for this step.**

## Express Clean Mode:

*Recommended Cleaning Pace: 30.5cm/s*

1. Press the Spray Trigger to apply solution while making 2 wet passes (1 forward, 1 back).
2. Release the Spray Trigger.
3. Make 2 dry passes (1 forward, 1 back) to suck up the dirty solution. **Do not hold down the trigger for this step.**

**NOTICE:** To prevent damage to Berber carpets, avoid repeated strokes in the same area.

# Cleaning with CleanShot

1



Press the CleanShot button with your foot. The window of the button will be green and show an "I" symbol when it is on.

2

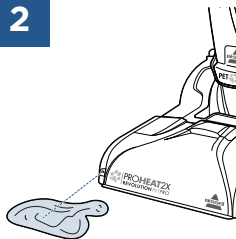

Spray will continue until you turn it OFF. To turn CleanShot OFF, press the button with your foot. The window of the button will be red and show an "O" symbol when it is off.

Completely cover the stain with CleanShot spray. Allow the stain to soak. To extract, manoeuvre the foot of the machine over the stain to brush and remove.



# Cleaning Area Rugs

**IMPORTANT:** Check manufacturer's tag before cleaning area rugs for specialized cleaning instructions. We do not recommend cleaning delicate, silk, wool, antique, or area rugs without a manufacturer's tag.

## Regularly clean your high-traffic area rugs in Express Clean Mode:

- » Check the manufacturer's tag.
- » Select Express Clean Mode.
- » When cleaning area rugs, place the rug on a sealed surface to test for colourfastness in an inconspicuous area. Your cleaner should not be used on unsealed surfaces.
- » Important: Keep the Foot of the carpet cleaner perpendicular to the rug's edge with each cleaning pass to prevent damage.

# Cleaning with Hose and Tools

- » Keep hair, loose clothing, fingers, and all parts of body away from openings and moving parts.
- » The Brush Roll continues to turn while product is turned ON and Handle is in upright position. To avoid damage to carpet, rugs, furniture, and flooring, avoid tipping cleaner or setting it on furniture, fringed area rugs or carpeted stairs during tool use.
- » With Brush Roll on, do not allow cleaner to sit in one location for an extended period of time, as damage to floor can result.

1

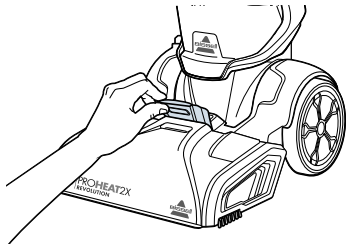

Lift the Accessory Hose Door on top of foot on the front of the machine. The door flips toward the machine to open.

2

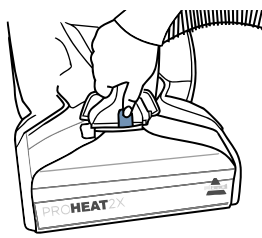

Insert the hose and snap into place. Be sure the coloured hose release clip is facing out, away from machine.

3

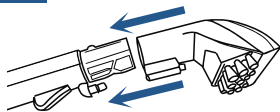

Attach the tool to the end of the hose. (Tools may vary by model.) Press the Power Switch to turn machine ON.

4

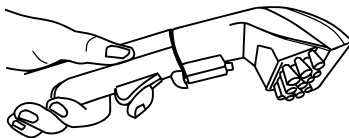

Press the Spray Trigger to spray the soiled area, then slowly move tool back and forth over the area.

Release the trigger to suck up the dirty solution. Work in small sections until the area is clean.

When finished cleaning, turn the machine ON to suction up warm clean water to rinse the inside of the hose and tool. Detach the hose and tool and close the Accessory Hose Door. Let the hose and tool air dry before storing.

# Using the 2-in-1 Pet Upholstery Tool

\*Make sure your Clean Water Tank has water & formula to use the tool in wet mode.

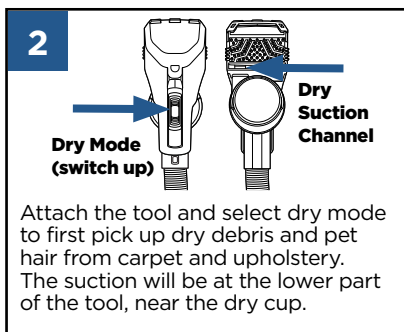
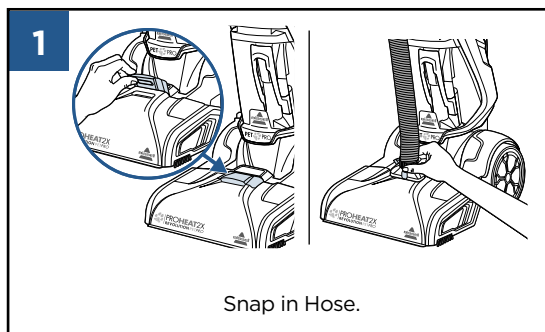

**DRY MODE NOTE:** Use a “raking” motion to clean carpets and upholstery. Start with the tool farthest away and rake in small increments as you bring the tool toward you. The rubber nubs will help attract hair to the suction channel.

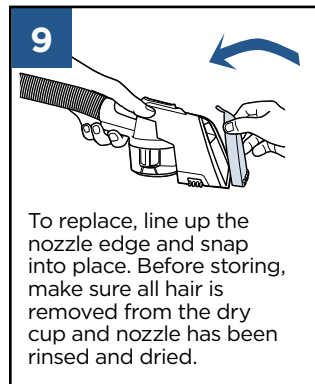
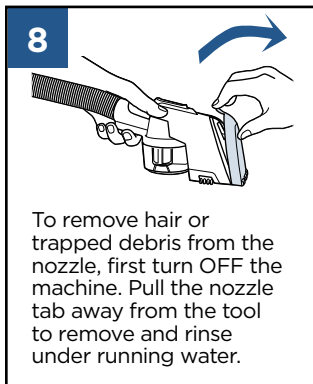
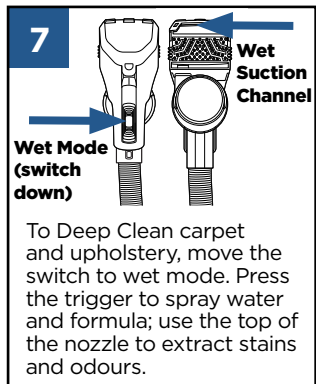
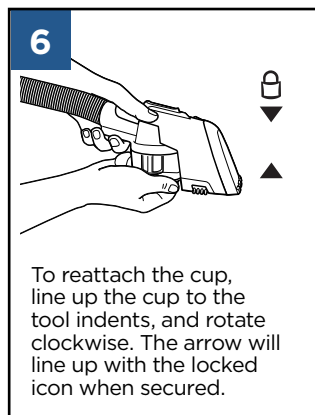
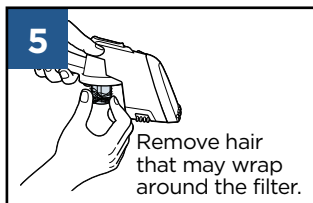
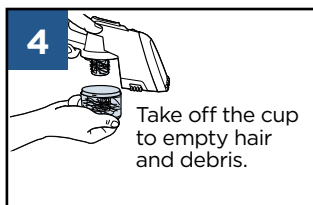
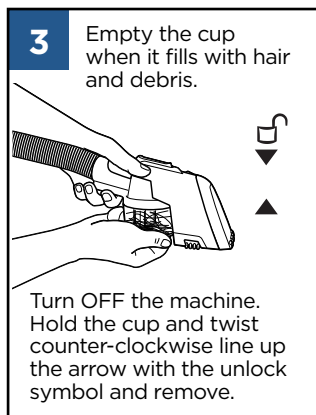

**WET MODE NOTE:** Start from the area farthest away. Hold the trigger down, and pull the tool toward you. Keep the tool in contact with the surface as you pull. You will see extraction through the nozzle.

# Using the 3-in-1 Stair Tool

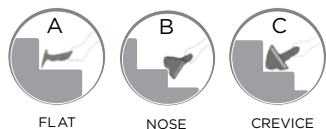

Attach the 3-in-1 Tool to the cleaning hose. This versatile 3-way tool sprays, scrubs and suctions up dirt and stains from the outer curves, corner and tread of stairs and upholstery. Twist the tool head to desired setting to clean. The downward facing edge is the active cleaning mode: (a) use the flat area to clean top of stairs and upholstery, (b) use pointed edge to clean inside crevices, (c) use indented area to clean outer corners.

# Emptying the Dirty Water Tank

**⚠ WARNING** To reduce the risk of fire, electric shock or injury, turn power OFF and disconnect plug from electrical outlet before performing maintenance or troubleshooting.

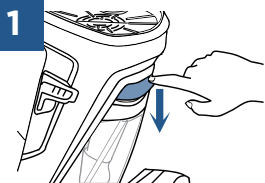

**1**  
To release Dirty Water Tank, press down on the coloured tank handle.

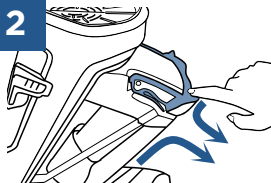

**2**  
Tilt the tank slightly toward you. Grab the handle and tank with both hands.

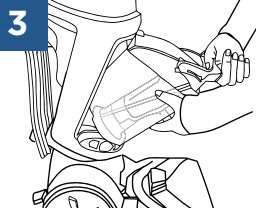

**3**  
Pull Dirty Water Tank up and away to remove.

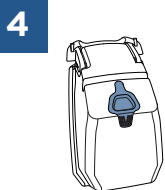

**4**  
**For quick empty:**  
Pull the Rubber Tab and tilt to pour. When closing the tab, make sure all edges are sealed tight.

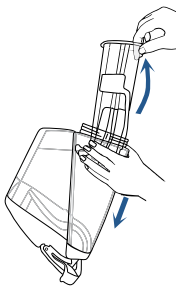

**For final clean and rinse:** Unscrew the ring at the bottom of the tank. Remove the Float Stack and rinse and clean. Once clean, put float back in tank by lining up the arrows so they point at each other. With arrows aligned, the float should lock into place. Return the ring and twist to lock. Water may leak if it's not tight.

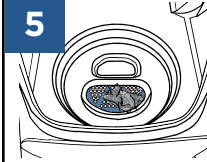

**5**  
Clean the red filter below the Dirty Water Tank by wiping off any remaining dirt or debris.



**6**  
Angle the tank and insert bottom first. Then tilt the tank toward the machine and push the top in until it clicks into place.

## Did You Know?

The Float Stack is what prevents your Dirty Water Tank from overflowing.

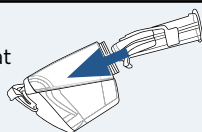

# Cleaning Machine After Use

1

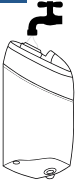

First, fill the Clean Water Tank with warm tap water and then empty it all to rinse. Then fill again with warm tap water and return the tank to the machine. Twist cap back on tightly.

2

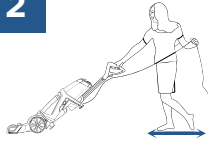

## To flush and rinse machine:

Turn the machine ON and press the Spray Trigger for 15 seconds while making back and forth passes on a section of carpet. Release the trigger and suck up the water.

Empty the Clean Water Tank and let dry before storing. Wipe your machine's exterior with a soft cloth.

# Maintaining the Brush Roll & Nozzle

**⚠ WARNING** To reduce the risk of fire, electric shock or injury, turn power OFF and disconnect plug from electrical outlet before performing maintenance or troubleshooting.

**NOTE:** Be sure to clean the Brush Rolls and nozzle before storing your machine. Follow these steps if your nozzle becomes clogged with hair or debris.

1

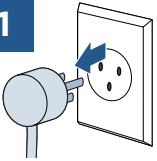

Turn OFF and unplug the machine from the grounded outlet.

2

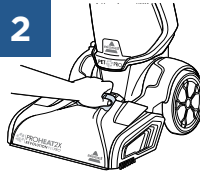

Remove the nozzle from the Foot: scoop and grip the Accessory Hose Door. Pull up to remove the nozzle.

3

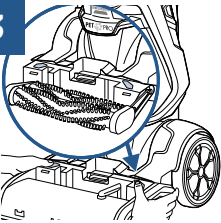

Next, remove the Brush Roll cover to reveal the Brush Rolls. Press on the two release buttons and lift straight up.

4



At this point, the nozzle and Brush Roll cover can be rinsed under running water. The Nozzle Clean Out Tool can be inserted to unclog hair or debris.

5

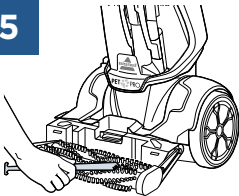

Use the comb to brush out the debris or hair from the Brush Rolls.

6

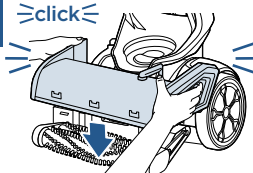

Return the Brush Roll cover by pushing it straight down. You will hear a "click" from each push button when the cover is pushed down into place. Line up the nozzle from the edge near the floor and rotate to snap back into place.

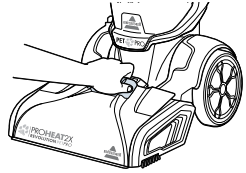

**NOTICE:** To reduce the risk of a leaking condition, do not store machine where freezing may occur. Damage to internal components may result.

# Replacing Belts & Brush Rolls

**⚠️ WARNING** To reduce the risk of fire, electric shock or injury, turn power OFF and disconnect plug from electrical outlet before performing maintenance or troubleshooting.

**What you will need: 1 Phillips-head screwdriver & 1 flathead screwdriver**

1

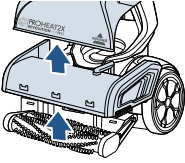

Unplug the machine and remove both tanks. Remove the nozzle and Brush Roll Cover.

2



Press the Recline Pedal and lay the machine on its back.

3

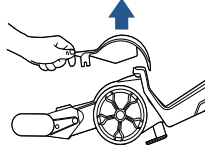

Press a flathead screwdriver in the slot in the back and then the front of the Belt Access Door. Lift to remove.

3

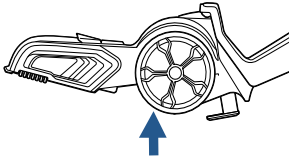

Turn the machine on its side and use a Phillips-head screwdriver to remove the screw just underneath the wheel. Slide the wheel down to remove.

4

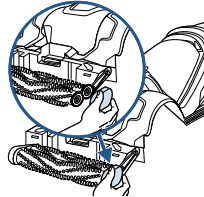

Lay the machine back down on its back. Use a Phillips-head screwdriver to remove the screw on the Brush Roll Endcap.

5

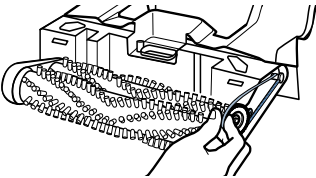

If the Gear Belt is broken, gently remove it. If you are replacing your Brush Rolls, gently remove the belt.

6

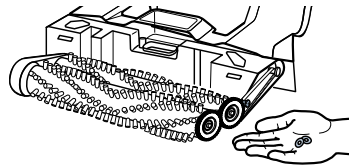

There are washers at the ends of the Brush Rolls, be careful that these do not fall off or get lost.

**NOTE:** To replace Brush Rolls, remove them from the metal posts and replace. Make sure the metal post goes completely through the end of the Brush Roll. The Brush Roll bristles should be aligned in a 'V' pattern as pictured.

# Replacing Belts & Brush Rolls (cont.)

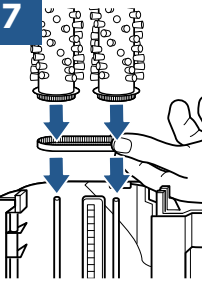

Align Brush Rolls with belt at other end. To ensure alignment, hold the end of one Brush Roll and twist. The other Brush Roll rotates with it. **Check that washers are in place.** Reassemble the belt and endcap, securing with screws you removed.

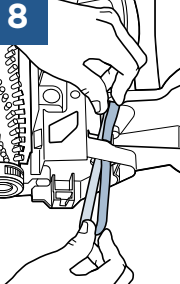

If the flat belt is broken, gently remove it. If it needs to be replaced, make sure the gear belt is removed before removing the flat belt. Turn the machine on its side. Feed the new flat belt through the opening so it wraps around the red pulley.

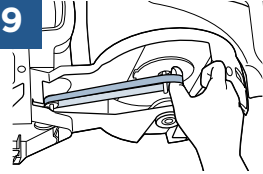

Keep it wrapped on the red pulley and adjust the machine so it is laying on its back again. Use your thumb to stretch the flat belt back to wrap around the metal axle.

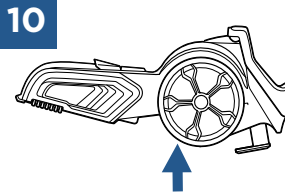

## Resecure the Wheel and Belt Access Door:

Slide the wheel up back into the slot and secure with the screw that was removed.

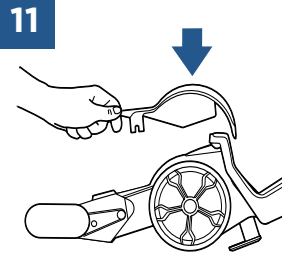

Snap the Belt Access Door back down into place.

## 12

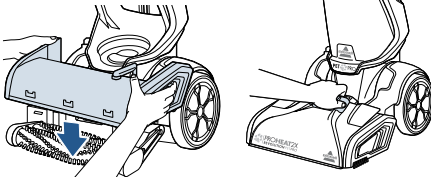

When finished, return the Brush Roll cover by pushing it straight down. You will hear a “click” from each push button when the cover is pushed down into place. Line up the nozzle from the edge near the floor and rotate to snap back into place.

# Troubleshooting



**WARNING** To reduce the risk of fire, electric shock or injury, turn power OFF and disconnect plug from electrical outlet before performing maintenance or troubleshooting.

Problem	Possible causes	Remedies
<b>Reduced or no spray through Foot of machine</b>	Clean Water Tank may be empty.	Refill tank.
	Clean Water Tank may not be seated completely.	Turn power OFF. Remove and reseat tank.
<b>No spray through hose &amp; tool</b>	The hose to your machine is not primed or may have lost prime.	1. With the machine OFF and unplugged, remove the nozzle from the Foot. Place a ballpoint pen in the black cylinder next to the screw. When water bubbles up, remove the pen. Reassemble the nozzle and hose. 2. Hold end of hose below water level in tank to prime. 3. With the Clean Water Tank full of water, the machine OFF and RECLINED, press the CleanShot button ON and wait for the CleanShot to drain for a few seconds. This will re-prime the machine.
	Clean Water Tank may be empty.	Refill the tank.
	Clean Water Tank may not be seated properly.	Turn power OFF. Remove and reseat the tank.
<b>No spray through CleanShot</b>	Clean Water Tank may be empty.	Refill the tank.
	Clean Water Tank may not be seated properly.	Turn power OFF. Remove and reseat the tank.
	The machine is not reclined.	Press the Recline Pedal and bring the handle down to recline the machine.
	Pump may have lost prime.	With the machine OFF and unplugged, remove the nozzle from the Foot. Place a ballpoint pen in the black cylinder next to the screw, when water bubbles up, remove the pen, reassemble the nozzle before cleaning again.
<b>CleanShot continues spray when machine is OFF</b>	CleanShot button is not in the off position.	Press the CleanShot button to turn it off. The button window will show the colour red and a "0" symbol when it is in the off position.
<b>Loss of suction power</b>	Dirty Water Tank may not be seated properly.	Pick up the tank and reseat so it fits in the machine.
	Dirty Water Tank has picked up maximum amount of dirty water and has reached the full line.	Empty tank.
	Rubber Tab on Dirty Water Tank is not sealed tight.	Check the Rubber Tab on the tank and press firmly on all edges to secure it tightly (see step 4 on page 11 for detail).
	Accessory Hose Door may not be closed tightly in place.	Check the Accessory Hose Door and make sure it is closed tightly – it should be locked into place.
	Nozzle may be dogged from pet hair or debris.	Use the Nozzle Clean Out Tool and follow steps on page 12 for "Maintaining the Brush Roll & Nozzle".
	Brush Roll cover not fully snapped into place.	Remove and replace the nozzle and Brush Roll cover; Follow step 6 from page 12 and make sure you hear both buttons click into place.
<b>No power</b>	Cleaning Mode Switch mistaken for Power Switch.	Flip the Power Switch on the left side of the machine to turn it ON.
	Outlet may not be active.	Try plugging in a different device that uses a grounded outlet to test for power from the outlet.
<b>Leaking tank</b>	Tank may have been overfilled.	1. Make sure your tank has the water and formula in it that you've prepared.
	Water may be caught in space between the tank and the tank's handle.	2. With the cap twisted on tightly, hold your tank at an angle, over a sink or drain, so any extra water can pour out of the space. 3. Wipe the tank dry with a cloth.

# Consumer Guarantee

This guarantee gives you specific legal rights, in addition to rights you may have under the Australian Consumer Law. If you need additional instruction regarding this guarantee or have questions regarding what it may cover, please contact your local BISSELL® Consumer Services on the details set out below.

## Limited 2 Year Guarantee (from the date of purchase by original purchaser)

Subject to the \*CONDITIONS identified below, BISSELL will repair or replace (with new, refurbished, lightly used, or remanufactured components or products), at BISSELL's option, free of charge, any defective or malfunctioning part due to manufacturer defect. This guarantee applies to product used for personal purposes, and not commercial or rental service. This guarantee does not apply to fans or routine maintenance or consumable components such as filters, belts, Brush Rolls, etc., damage or malfunction caused by negligence, abuse, neglect, unauthorized repair, or any other use not in accordance with the user guide. BISSELL recommends that the original packaging be kept for the duration of the guarantee period in case such need arises within the guarantee period that the item needs re-packing and transportation.

It may be necessary to obtain some of your personal information, such as a mailing address, to fulfill terms of this guarantee. Any personal data will be handled pursuant to BISSELL's Privacy Policy, which can be found at [www.BISSELL.eu](http://www.BISSELL.eu).

### \*CONDITIONS OF THE GUARANTEE

Subject to whether such loss is reasonably foreseeable, BISSELL and its in-country distributors are not liable for incidental or consequential damages of any nature associated with the use of this product.

### FOR AUSTRALIAN CONSUMERS ONLY:

OUR GOODS COME WITH GUARANTEES THAT CANNOT BE EXCLUDED UNDER THE AUSTRALIAN CONSUMER LAW. YOU ARE ENTITLED TO A REPLACEMENT OR REFUND FOR A MAJOR FAILURE AND FOR COMPENSATION FOR ANY OTHER REASONABLY FORESEEABLE LOSS OR DAMAGE. YOU ARE ALSO ENTITLED TO HAVE THE GOODS REPAIRED OR REPLACED IF THE GOODS FAIL TO BE OF ACCEPTABLE QUALITY AND THE FAILURE DOES NOT AMOUNT TO A MAJOR FAILURE.

THIS GUARANTEE IS IN ADDITION TO OTHER RIGHTS OR REMEDIES UNDER LAW. NOTHING IN THIS GUARANTEE EXCLUDES, LIMITS OR MODIFIES ANY LIABILITY OF BISSELL WHICH IS IMPOSED BY LAW, OR LIMITS OR MODIFIES ANY REMEDY AVAILABLE TO THE CONSUMER WHICH IS GRANTED BY LAW. TO MAKE A CLAIM UNDER THIS GUARANTEE CONTACT BISSELL AUSTRALIA PTY LTD (DETAILS BELOW). CONTACT BISSELL PRIOR TO RETURNING ANY GOODS. WHERE AGREED, BISSELL WILL REIMBURSE REASONABLE POSTAGE / HANDLING COSTS (IF ANY) FOR RETURNING GOODS TO BISSELL. TO CLAIM EXPENSES INCURRED IN MAKING A CLAIM UNDER THIS GUARANTEE PLEASE PROVIDE BISSELL WITH A COPY OF THE RECEIPT OF THE EXPENSES BY EMAIL OR POST.

# Consumer Care

If your BISSELL® product should require service or to claim under our limited guarantee, please contact us as follows:

### Website and Email:

[www.BISSELL.com.au](http://www.BISSELL.com.au)  
[www.bissell.co.nz](http://www.bissell.co.nz)

### Telephone:

Australia: 1300-247-735  
New Zealand: 0800-247-735

### Write:

BISSELL AUSTRALIA PTY LIMITED  
42 Rocco Dr.  
Scoresby 3179  
Victoria  
Australia

Replacement parts and accessories are available for purchase.  
To purchase visit [BISSELL.com](http://BISSELL.com)

### Visit the BISSELL website: [BISSELL.com](http://BISSELL.com).

When contacting BISSELL, have model number of cleaner available.

Please record your Model Number: \_\_\_\_\_

Please record your Purchase Date: \_\_\_\_\_

**NOTE: Please keep your original sales receipt. It provides proof of the date of purchase in the event of a guarantee claim. See guarantee for details.**



©2020 BISSELL Inc  
All rights reserved. Printed in China  
Part Number 1623271 02/20 RevA