

# *the Smart Mist Top™ Connect<sup>®</sup> Humidifier*

Instruction Book - LAH508



**Breville®**



## Contents

- 2 Breville Recommends Safety First
- 8 Components
- 9 Control Panel
- 10 Features
- 10 Assembly
- 12 Functions
- 17 Wi-Fi Connectivity  
& Voice Assistants
- 21 Care, Cleaning & Storage
- 24 Troubleshooting

## BREVILLE RECOMMENDS SAFETY FIRST

At Breville we are very safety conscious. We design and manufacture consumer products with the safety of you, our valued customer, foremost in mind. In addition, we ask that you exercise a degree of care and adhere to the following precautions.

## SPECIFICATIONS

Product Dimensions (HxWxL mm)	335 x 224 x 224mm
For room size	20 to 40m <sup>2</sup>
Noise level (Max)	35dBA
Power Consumption	110W
Weight	2.8kg
Water Capacity	4.5L
Evaporation Rate	Warm mist 450ml/h +/-50ml/h
OS Compatibility	Android® 5.0 or later and iOS 9.0 or later



### NOTE

Not compatible with Google Home, Amazon Alexa or other similar voice-assisted appliances.

## IMPORTANT SAFEGUARDS

READ ALL  
INSTRUCTIONS BEFORE  
USE AND SAVE FOR  
FUTURE REFERENCE

- Carefully read all instructions before operating the humidifier for the first time and save for future reference.
- Remove and safely discard any packaging material and promotional labels before using the humidifier for the first time.

- To eliminate a choking hazard for young children, remove and safely discard the protective cover fitted to the power plug of this humidifier.
- When unpacking the humidifier, check to see you have received all the items listed in the parts list before discarding the packaging.
- Always ensure the humidifier is properly assembled before use. Follow the instructions provided in this book.
- Always operate the humidifier on a stable surface. Ensure that the surface is level, clean and free of water and other substances.
- Do not operate the humidifier on an incline plane. Do not move while the humidifier is switched on.
- Do not place the humidifier near the edge of a bench or table during operation.
- Do not place the humidifier on a rug, carpet, wooden flooring, or any other surface that may be damaged by exposure to water or moisture. It is recommended that a waterproof mat or pad is placed under the humidifier.
- Do not operate the humidifier on a sink drain board.
- Do not locate the humidifier directly below or close to a mains electricity supply socket.
- Do not use the humidifier without water in the water tank.
- Do not use the humidifier unless it has been cleaned according to instructions.
- Mist may not be visible in certain conditions (impacted by light, background colour, etc.) or at lowest setting.
- Suitable for use in dry locations only. Do not use outdoors or on wet surfaces. Do not use in bathrooms, laundry areas or similar indoor locations.
- Room ventilation is required if condensation becomes visible on windows, walls or floor.
- Never place the humidifier where it may fall into a bath or other water container. Do not use or store where it may get wet or in the immediate surroundings of a bath, a shower, or a swimming pool.

- Do not use in areas where petrol, paint, or flammable liquids are used or stored or where there are vapours present. Do not use in conjunction with or directly next to an air freshener or similar products.
- Do not spray any flammable materials such as insecticides or fragrance around the humidifier.
- Do not use this humidifier when you have used indoor smoke-type repellents or in places with oily residue, burning incense or chemical fumes.
- Do not pour water into any openings except for the water tank. Do not allow water to enter the air outlets on top of the humidifier.
- When filling or refilling, only fill the water tank with cold tap water or distilled water. Do not use ground water or hot water.
- Always switch the humidifier off and then unplug from the power outlet:
  - Before filling or emptying the water tank.
  - Before cleaning and maintenance, unless otherwise specified in this booklet.
- Immediately after use.
- Always use clean tap or distilled water to prevent clogging and damage to the transducer.
- Do not put any substance other than water in the water tank. Do not add fragrance or any chemical substance into the water. Use only water (tap, purified, mineral, any sort of portable water). If other additives are used, the plastic material and the membrane may become discoloured and/or damaged.
- Water in the water tank is not suitable for drinking. Do not drink this water, and do not use it to feed animals or water the plants. When you empty the water tank, pour the water in the water tank down a drain.
- Do not use the humidifier in a room with major temperature changes as this may cause condensation inside the humidifier.
- If not using the humidifier for a long time, clean and dry the water tank before storage.
- Clean the water tank every week.

- Always disconnect the humidifier from the power supply and empty the water tank before moving. Always carry the humidifier upright.
- It is important to check the humidity of your ambient air regularly. Intensive continuous operation can cause the ambient air to become excessively humid.
- A comfortable humidity level is considered to be between 40%RH to 60%RH.
- Never use the humidifier underneath a cover such as a blanket, pillow, etc.
- Never plug in or switch on the humidifier without filling the removable water tank with water and correctly replacing the tank onto the base of the humidifier.
- Do not remove the mist nozzle during operation.
- Position the humidifier so that the mist nozzle is not directed towards objects or a wall as the immediate vicinity of the air humidifier may become damp.
- The humidifier is not intended to be operated by means of an external timer or separate remote-control system or any other device that switches the humidifier on automatically.
- Do not use chemicals, steel wool, metal scouring pad or abrasive cleaners to clean the outside of the humidifier housing as these can damage the housing of the humidifier.
- Cleaning procedures must be routinely followed to ensure that the humidifier continues to operate efficiently.
- Empty any remaining water from the water tank and water inlet basin when the humidifier is not in use.
- You may optionally add drops of essential/scented oils to the aroma tray. This will emit a pleasant odour into the surrounding area.
- The air humidifier transducer is highly sensitive. Do not touch the transducer with bare fingers or scrape it with any metal tools, as it may reduce the mist output permanently.
- Keep the humidifier clean. Follow the cleaning instructions provided in this book.

## IMPORTANT SAFEGUARDS FOR ALL ELECTRICAL APPLIANCES

- Fully unwind the power cord before use.
- Connect only to a 230V or 240V power outlet.
- Do not let the power cord hang over the edge of a bench or table, touch hot surfaces or become knotted.
- To protect against electric shock, do not immerse the power cord, power plug or appliance in water or any other liquid or allow moisture to come in contact with the part, unless it is recommended in the cleaning instructions.
- The appliance is not intended for use by persons (including children) with reduced physical, sensory or mental capabilities, or lack of experience and knowledge, unless they have been given supervision or instruction concerning use of the appliance by a person responsible for their safety.
- Children should be supervised to ensure that they do not play with the appliance.
- It is recommended to regularly inspect the appliance. To avoid a hazard, do not use the appliance if power cord, power plug or appliance becomes damaged in any way. Return the entire appliance to the nearest authorized Breville Service Centre for examination and/or repair.
- Any maintenance other than cleaning should be performed at an authorised Breville Service Centre.
- This appliance is for household use only. Do not use this appliance for anything other than its intended use. Do not use in moving vehicles or boats. Do not use outdoors. **Misuse may cause injury.**

- The installation of a residual current device (safety switch) is recommended to provide additional safety protection when using electrical appliances. It is advisable that a safety switch with a rated residual operating current not exceeding 30mA be installed in the electrical circuit supplying the appliance. See your electrician for professional advice.
- During electrical storms, the appliance should be disconnected from the power source at the wall socket to prevent any electrical surges that may arise during the storm and which may inadvertently cause damage to the appliance and its electronic componentry.
- Always turn the appliance to the off position, switch off at the power outlet and unplug at the power outlet when the appliance is not in use.
- Before cleaning, always turn the appliance to the off position, switch off at the power outlet, unplug at the power outlet and remove the power cord, if detachable, from the appliance and allow all parts to cool.
- Do not place this appliance on or near a heat source, such as hot plate, oven or heaters.
- Position the appliance at a minimum distance of 20cm away from walls, curtains and other heat or steam sensitive materials and provide adequate space above and on all sides for air circulation.

 **WARNING**

To avoid electric shock, do not connect the plug to the power outlet when hands are wet.

**FOR HOUSEHOLD USE ONLY  
SAVE THESE INSTRUCTIONS**



## Components

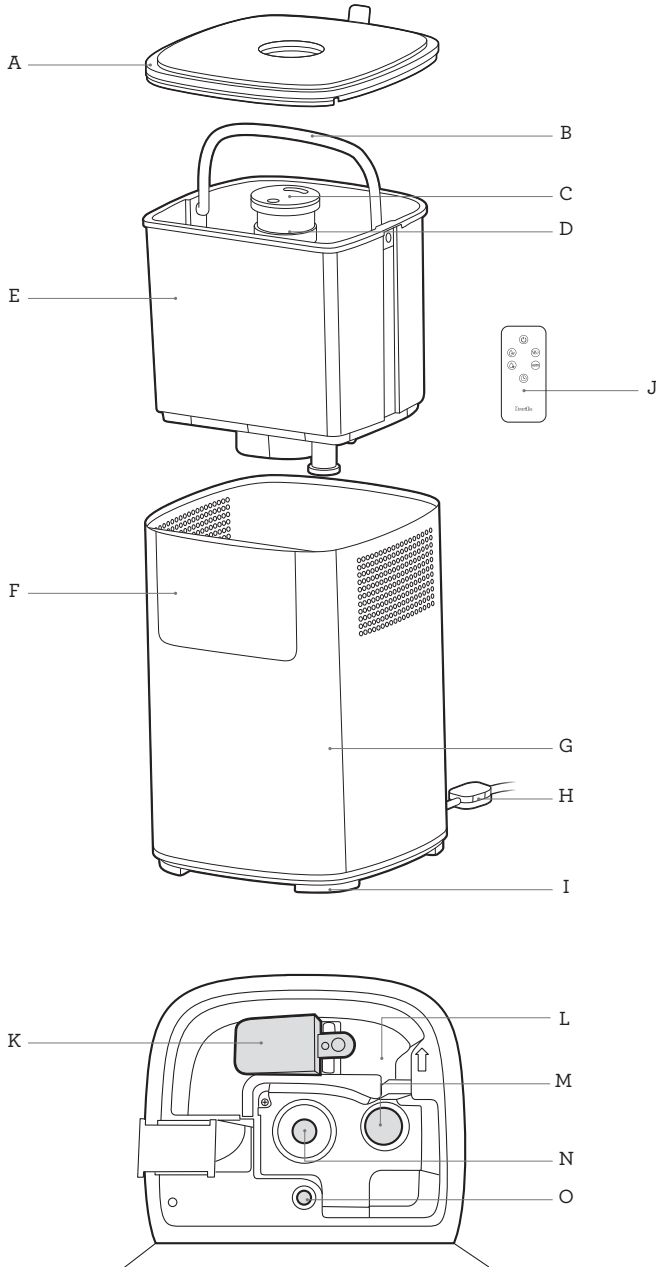

- A. Top Cover
- B. Water Tank Handle
- C. Mist Nozzle
- D. Mist Guide
- E. Removable Water Tank
- F. Control Panel
- G. Body
- H. Sensor
- I. Non-slip Feet
- J. Remote Control
- K. Water Buoy
- L. Water Inlet Basin
- M. Heating Plate
- N. Transducer
- O. Mood Light

### NOT PICTURED

- Aroma Tray & Felt Pad
- Water Purification Filter
- Power Cord and Plug





# Control Panel

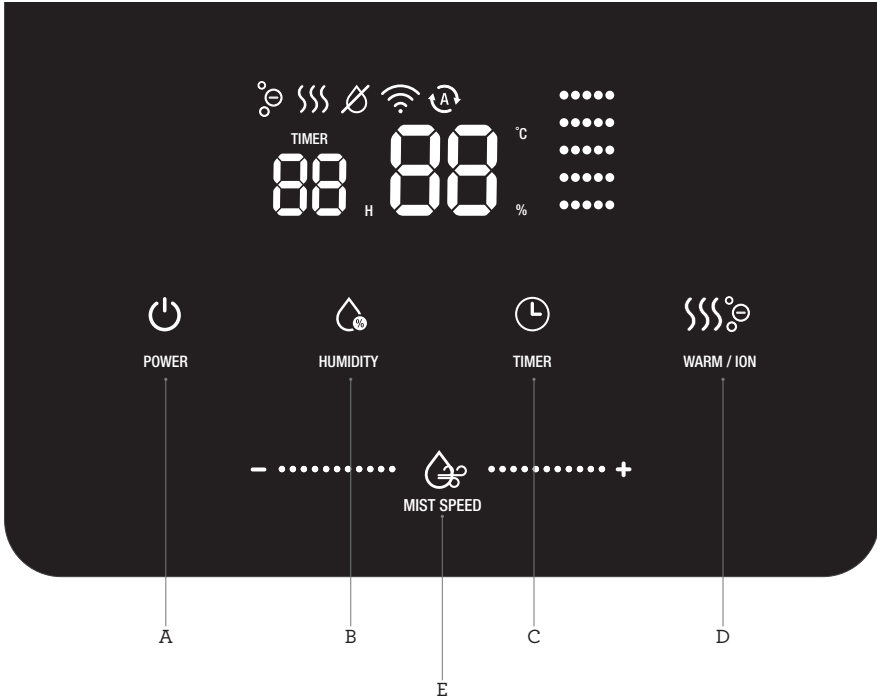

- A. Power On/Off and Wi-Fi
- B. Humidity and Night Mode
- C. Timer
- D. Warm/Ion and Mood Light
- E. Mist Level Control  
Scroll left or right to change the mist level.

## DISPLAY SCREEN ICONS

- ION
- Warm Mist
- Water Tank Empty
- Wi-Fi
- Full Auto
- Mist Intensity Levels 1-5
- 12 Hour Timer



## Features

### WHAT IS A HUMIDIFIER?

Your Breville humidifier will assist in keeping a comfortable and healthy environment at home by artificially adding water vapour (moisture) to the surrounding atmosphere. It may assist with common winter symptoms such as dry skin, dry throat, cracked or dry lips, dry nasal cavity, and itchy eyes, as well as some sinus and respiratory issues.

### HOW DOES A HUMIDIFIER WORK?

Your Breville humidifier uses a high-frequency oscillator to break water into tiny water particles. The ventilation system then blows these water particles into the dry air in the form of a mist where it evaporates to increase the relative humidity.

### WHAT IS RELATIVE HUMIDITY?

Relative humidity (RH) is the amount of water vapour in the air and it is commonly expressed as a percentage of the maximum amount of water vapour that the air can hold at a given temperature. Every environment has a different humidity level. A standard comfortable level is considered to be between 40-60%RH.



## Assembly

### BEFORE FIRST USE

1. Before using your humidifier for the first time, remove all packaging material and promotional labels.
2. Check for any missing or damaged parts as per the components list.
3. Clean all parts according to the Care, Cleaning & Storage section.
4. Place the humidifier on a flat surface that will not be damaged by exposure to water or moisture.



### IMPORTANT

It is recommended that a waterproof mat or pad is placed under the humidifier when in use.

5. Remove the cover from the top of the humidifier and set aside.
6. Using the water tank handle, lift and remove the water tank from the humidifier body.
7. Ensure the water purification filter is fitted properly to the water tank.



### NOTE

The water purification filter is attached to the water tank. Ensure both are properly fitted before using the humidifier.

8. Fill the water tank up to the 'MAX' text outlined inside the water tank.



### IMPORTANT

Only fill the water tank with cold tap or distilled water. Do not use ground water or hot water.



9. Use the water tank handle to gently lower the water tank back into the humidifier body

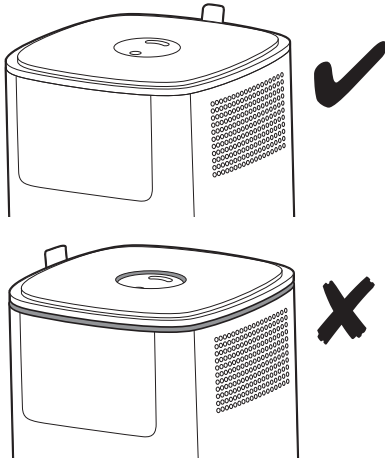

10. Ensure the mist nozzle is fitted correctly on the mist guide of the water tank. If tilted, lightly push the mist nozzle back onto the mist guide.
11. Replace the top cover back on the water tank, ensuring the tab sits in the top back of the humidifier. The top cover should sit flat and the mist nozzle should be flat to the top cover when correctly positioned on the humidifier.



 **IMPORTANT**

Ensure the top cover sits flat on the top of the humidifier. If the mist nozzle sits higher or lower than the top cover when in operation, condensation will build on the top cover and around the humidifier.

12. Connect the power plug to a 230V or 240V power outlet and switch the outlet on. The  POWER symbol will illuminate red and the  WI-FI icon will flash. The humidifier is now in Standby mode.

13. Touch the  POWER symbol to activate the control panel and display screen. The humidifier is now switched on and will automatically begin operation in  FULL AUTO mode.

 **IMPORTANT**

Water may remain in the water inlet basin even though the water tank may be empty. However, once the water in the tank and/or basin is too low to keep the humidifier running, the humidifier will stop working. Refill the tank with water. Do not use the humidifier without water in the water tank.



 **NOTE**

Take care when removing the water tank from the body after use as residual water may drip.



## Functions

### YOUR BREVILLE HUMIDIFIER

- The humidifier comes with a memory feature. When turned on from Standby mode, it will start on the settings used previously.
- The control panel lights will dim after approximately 30 seconds if not touched. Touch the  POWER symbol once, where the control symbols are located to wake up the screen, then select any function.
- The Timer, Night mode, Warm mist and ION features can be used in any mode.
- The humidifier will check the humidity level once every minute.
- The room temperature and humidity will alternate on the display screen approximately every 10 seconds when in operation on all modes except adjustable humidity mode.
- Manual adjustment of the Mist intensity control bar will exit any programmed settings, except ADJUSTABLE SPEED and manual setting.
- Touch and hold the WARM MIST symbol to turn off the mood light in the water tank. Repeat to turn back on.
- When empty, the  WATER TANK EMPTY icon will illuminate and the humidifier will automatically turn off.

### SENSAIR SYSTEM™ LIVE COMFORT CONTROL

- Your Breville Smart Mist Top™ Connect Humidifier has a sensor to detect changes to humidity and temperature in the surrounding area.
- On FULL AUTO and ADJUSTABLE SPEED modes, the SensAir System™ will automatically keep the humidity in the “Comfort Zone” by setting the appropriate level of relative humidity, depending on ambient air temperature for maximum comfort.

- To override the RH level touch the  HUMIDITY/NIGHT symbol. This will switch the mode to ADJUSTABLE HUMIDITY.



### OPERATING YOUR HUMIDIFIER



#### NOTE

When connected to the power outlet and turned on for the first time, the humidifier will operate for one minute in order to sense the ambient conditions, and then will enter FULL AUTO mode.

### FULL AUTO MODE

- FULL AUTO mode is the default setting for the humidifier when the unit is turned on from the power outlet. FULL AUTO mode can also be manually selected.
  - The Timer, Night mode, Warm Mist and ION features can be used with this setting. You do not need to adjust Humidity and Mist Intensity level in FULL AUTO mode.
1. Touch the  HUMIDITY/NIGHT symbol on the control panel until ‘AU’ illuminates. Once FULL AUTO mode is set, the  FULL AUTO icon, will illuminate on the display screen.
  2. FULL AUTO mode automatically adjusts the mist intensity to regulate the humidity level between 30-65%RH based on the temperature within the room.



#### NOTE

- FULL AUTO mode is not recommended where room temperatures reach above 30°C.
- The mist intensity level will not illuminate as it will automatically modulate to achieve the desired humidity level.

3. The humidifier will continue to monitor and regulate as required to maintain the comfort zone, adjusting the mist intensity. Once the comfort zone has been achieved, the humidifier will stop the mist intensity automatically and will then operate again if the humidity level falls below the comfort zone.
4. If the Timer has not been programmed, the humidifier will continue to operate in FULL AUTO mode until turned off manually, programmed to another mode or when the water tank is empty.

### NOTE



The room temperature shown on the display screen is taken only within the vicinity of the sensor and may be influenced by positioning, airflow and other environmental factors. Actual room temperature may vary slightly.

### SEMI-AUTO MODES

This humidifier can achieve 2 semi-auto modes: ADJUSTABLE SPEED and ADJUSTABLE HUMIDITY modes.

- In ADJUSTABLE SPEED mode, the humidifier automatically keeps the humidity in the comfort zone with the SensAir System™ while the mist intensity can be manually selected.
- In ADJUSTABLE HUMIDITY mode, the humidifier automatically adjusts the mist intensity to maintain a pre-selected relative humidity level.
- ADJUSTABLE SPEED and ADJUSTABLE HUMIDITY can only be accessed when the humidifier is on FULL AUTO mode.
- The Timer, Night mode, Warm Mist and ION features can be used with these modes.

### ADJUSTABLE HUMIDITY

To program ADJUSTABLE HUMIDITY, touch the  HUMIDITY/NIGHT symbol on the control panel repeatedly to cycle through until the desired RH flashes on the display screen. The RH number will flash 3 times then illuminate. The  FULL AUTO

icon will illuminate and the % icon will flash continuously during this setting. The humidifier will start automatically if the room humidity is lower than the selected humidity. If the room humidity is higher than the selected humidity, 'HI' will display on the display screen, and mist will not be released.

### NOTE

The humidity level can be selected in 5% increments between 30% and 90%.

The mist intensity level will not illuminate as it will automatically modulate to achieve the desired humidity level.

Once the chosen relative humidity has been reached, the mist will stop releasing and will automatically restart once the humidity level falls below the set humidity.

### ADJUSTABLE SPEED

To program ADJUSTABLE SPEED, touch or slide your finger along the

- .....  ..... + MIST LEVEL CONTROL bar on the control panel to change the mist intensity as desired. The mist intensity level will display and the on the right-hand side of the display screen, the mist intensity level will illuminate. The humidifier will start automatically if the room humidity is lower than the comfort zone.

If the ideal relative humidity is higher than the ideal humidity in the "Comfort Zone", 'HI' will display on the display screen and adjustable speed cannot be programmed.

### NOTE

The mist intensity level can be selected from LOW (1) to HIGH (5).

The room temperature and relative humidity will alternate on the display screen every 10 seconds when in operation.

Once the ideal relative humidity has been reached, the mist release will stop operating automatically and will restart once the humidity level falls below the set humidity for the room temperature.







## IMPORTANT

All operating modes will be cancelled if the water tank runs empty. The humidifier will automatically shut off when there is insufficient water to operate.

## MANUAL MODE

The humidity level and mist intensity can be manually set in a number of ways.

### To set MANUAL mode

- From ADJUSTABLE HUMIDITY, touch or slide your finger along the  .....  .....  MIST LEVEL CONTROL bar on the control panel to change the mist intensity as desired.
- From ADJUSTABLE SPEED, touch the  HUMIDITY/NIGHT symbol on the control panel repeatedly to cycle through until the desired RH flashes on the display screen.



## NOTE

Both mist intensity and the humidity can be set together on Manual mode.

The mist intensity levels can be manually selected between Low (1) to High (5).

The humidity level can be manually selected between 30% and 90%RH.

The Timer, Night mode, Warm Mist and ION features can be used with this setting.



The mist intensity will stop when the humidity level has been reached. The display will alternate between the word 'Hi', the current temperature and the current humidity level.

If the humidity in the room is higher than the selected humidity, 'HI' will display on the display screen and the user cannot enter Manual mode. To enter Manual mode, the user must select a humidity level that is higher than the room humidity.

## NIGHT MODE

- In NIGHT mode, the humidifier turns off the lights, except the blue mood light found in the water tank.
- Night mode can be selected in all modes.

- The Timer feature and Warm Mist feature can be used with this setting.



1. Touch and hold the  HUMIDITY/NIGHT symbol on the control panel. All the lights will turn off, except the mood light in the water tank, and the  POWER symbol will flash slowly.



## NOTE



Turn off the mood light manually before setting Night mode if not needed. Touch and hold the  WARM MIST/ION symbol to turn off the mood light in the water tank.

To reactivate the mood light, touch and hold the  WARM MIST/ION symbol. The mood light will illuminate.

2. Touch the  POWER symbol to reactivate the control panel. The control panel lights will illuminate and the humidifier is ready to be adjusted. Once the mode is adjusted, the control panel will dim back into Night mode.
3. To cancel night mode, touch and hold the  HUMIDITY/NIGHT symbol again for 3 seconds. The control panel lights will illuminate and the humidifier will continue to operate in the chosen mode.

## TIMER

This humidifier has a Timer feature that will turn the humidifier off after a chosen number of hours.



1. Touch the  TIMER symbol on the control panel repeatedly to cycle through 1 to 12 hours. The set time, current relative humidity and the temperature will alternate on the display screen.
2. When the desired number of hours is displayed, it will flash 3 times before starting the countdown.
3. The Timer will begin to count down in 1-hour increments. The humidifier will automatically turn off once the chosen time has elapsed.
4. To cancel this feature, touch and hold the  TIMER symbol until 'TIMER' and the number of hours disappear from the display screen.

## WARM MIST AND ION

### WARM MIST

- This humidifier has a WARM MIST feature. A small internal heating plate will heat the water to create a warm vapour.
- WARM MIST can be activated on its own, or together with ION, in all modes.
- WARM MIST can operate automatically in all modes.







### ION

- This humidifier has an ION feature. ION is generated and released in the mist. The ION will then catch and hold DUST particles in the air, helping to purify the air in the process.
  - ION can be activated on its own, or together with WARM MIST, in all modes.
  - ION can operate automatically in all modes.
1. Touch the  WARM MIST/ION symbol on the control panel to turn on warm mist. The  WARM MIST icon will illuminate on the display screen and warm mist will emit from the mist nozzle gradually within 10-15 minutes.



### NOTE

Warm mist will start after the water has time to heat. The time will vary depending on factors such as the temperature of the water in the tank.

2. Touch the  WARM MIST/ION symbol again. The  ION icon will illuminate on the display screen and ION will emit from the mist nozzle through the mist.
3. To turn WARM MIST off, but keep ION on, touch the  WARM MIST/ION symbol again. The <Insert WARM MIST icon here> WARM MIST icon will stop illuminating on the display screen, while the  ION icon will remain illuminated. ION will continue to emit from the mist nozzle.
4. To turn ION off, touch the  symbol again. The  ION icon will stop illuminating on the display screen. Both WARM MIST and ION are now off.

## AROMA TRAY





- Press the aroma tray on the side of the humidifier and it will click out of the unit.
- Add 2-3 drops of essential oil (not included) directly to the pad in the aroma tray.
- Push the aroma tray back into the humidifier until it clicks into place.
- Turn the humidifier on and the aroma will start emitting automatically with the mist. Increase the mist intensity as desired.



### WARNING

Never add essential oil directly to the water tank, the water inlet basin or any other part of the humidifier except the aroma tray felt pad. Do not use more than 2-3 drops of oil on the aroma tray felt pad at any one time. Only add more oil when the aroma in the surrounding air has dissipated.

### AUTO SHUT-OFF

- Once the water in the water tank and water inlet basin is too low to keep the machine running, the  WATER TANK EMPTY icon will illuminate red on the display, 3 beeps will sound and the humidifier will stop working. The  POWER symbol will turn red and stay illuminated.
- Fill the water tank, turn the humidifier on and program the desired mode.
- To recommence, turn the humidifier off at the power outlet, fill the tank and reprogram. The  WATER TANK EMPTY icon will stop illuminating and the humidifier will start.
- If night mode is activated, the humidifier will not beep when the  WATER TANK EMPTY icon illuminates.



### IMPORTANT

All operating modes will be cancelled if the water tank runs empty. The humidifier will automatically shut off when there is insufficient water to operate.

## USING THE REMOTE CONTROL

The humidifier comes equipped with a remote control which can be used to operate many functions on the humidifier.



### NOTE

On first use, remove the transparent plastic protector that separates the Lithium battery from the connectors.

- A CR2025 3V Lithium battery is provided with the remote. When it is time to replace the battery, open the battery compartment at the back of the remote, pushing the small arched groove to the right and simultaneously pulling out the battery compartment cover by pushing the rectangular groove.

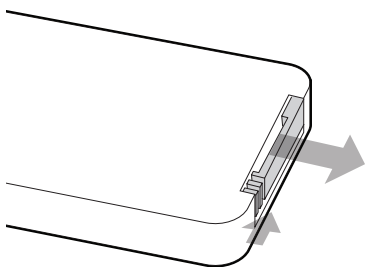

- Insert the battery, paying attention to the polarity (+ and -). Reinsert the battery compartment into the remote control ensuring that the + symbol is facing upwards when inserted. Make sure the battery compartment is correctly secured.

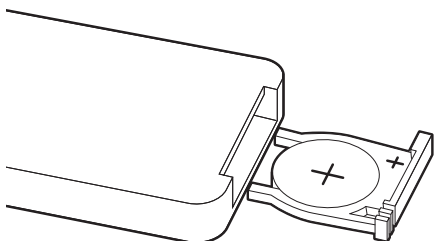

- To use the remote control, point it at the display screen on the humidifier and used within five meters.



### HINT

When correctly inserted, the text on the battery will be facing the bottom of the remote and the compartment is fitted correctly when it slides in all the way.

## WARNING FOR BUTTON BATTERIES KEEP OUT OF REACH OF CHILDREN

- Swallowing may lead to serious injury in as little as 2 hours or death, due to chemical burns and potential perforation of the oesophagus.
- If you suspect your child has swallowed or inserted a button battery immediately call the 24-hour Poisons information Centre on 13 11 26 for fast, expert advice.
- Examine devices and make sure the battery compartment is correctly secured, e.g. that the screw or other mechanical fastener is tightened. Do not use if compartment is not secure.
- Dispose of used button batteries immediately and safely. Flat batteries can still be dangerous.
- Tell others about the risks associated with button batteries and how to keep their children safe.





## Wi-Fi Connectivity

The Smart Mist Top™ Connect Humidifier can offer remote operation by using a home Wi-Fi connection and the Breville Home Connect™ app downloaded to a compatible mobile phone, through the Google Play store or Apple App store.

To go straight to the appropriate app store, scan the QR code below.



For instructions on how to use the app, scan the QR code below, refer to the Quick Start Guide that can be found in the box or go to [tinyurl.com/HomeConnectQuickStart](http://tinyurl.com/HomeConnectQuickStart).



### NOTE

The Breville Home Connect™ app is compatible with mobile phones running Android® 5.0 or later and iOS devices 9.0 or later.





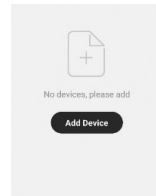

### NOTE

To control the humidifier using the app, the humidifier must be plugged into an active power outlet and switched on at the power outlet. If the humidifier is switched OFF at the power outlet or disconnected from the power outlet, then the app cannot connect to the humidifier via the network.

## CONNECT YOUR HUMIDIFIER TO WI-FI

1. Ensure the mobile device is connected to a home Wi-Fi network.
2. The humidifier must be on standby mode. Once the  icon flashes rapidly on the display screen, the humidifier is ready to connect.
3. Log into your Breville Home Connect™ app account and stay on the “Home” page. To add the humidifier to the list, touch ‘Add Device’ or the symbol found in the top right-hand corner of the screen. Follow the prompts in the app to scan the device (recommended) or connect in manual EZ mode (default).



4. If the connection is successful, the humidifier will appear in the main page of the app and the  icon on the humidifier will illuminate.
5. If the connection is not successful, the  icon will flash slowly. Touch and hold  for 3 seconds until 1 beep sounds. The  icon will flash rapidly, and the humidifier is ready to connect to the app through EZ Mode again.
6. If EZ mode failed to connect, follow the prompts in the app to automatically begin AP mode (manual mode). To connect through AP mode, touch and hold  for 5 seconds until 2 beeps sound. The  icon will flash slowly. Follow the prompts in the app to connect in manual AP mode.

### NOTE

To return to EZ mode from AP mode, touch and hold  for 3 seconds.



## Voice Assistants

The Breville Smart Mist Top™ Connect comes with the added feature of voice assistance, allowing you to control your humidifier using your voice by linking your Breville Home Connect™ app with Amazon Alexa and Google Home/Assistant.

For instructions on how to link your Breville Home Connect™ app account with either Amazon Alexa or Google Home/Assistant refer to the instructions on [www.Breville.com](http://www.Breville.com) or follow instructions found in the Breville Home Connect™ app under **Me > Third-Party Voice Services > View more ways to link**.



### IMPORTANT NOTE

The recommended voice commands to operate the appliance's functions differ between Amazon Alexa and Google Home/Assistant as listed. Variations of these commands may also be recognised, however, if a command fails, check against the recommended voice command.



### NOTE

To control the humidifier using the Amazon Alexa or Google Home/Assistant app, the humidifier must be plugged in to an active power outlet and on standby mode.

## VOICE CONTROL WITH AMAZON ALEXA

Before you can voice control your Breville Smart Mist Top™ Connect with Amazon Alexa, you need to link the Breville Home Connect™ account to the Amazon Alexa app as per the instructions.

### Amazon Alexa Recommended Voice Commands for the Breville Smart Mist Top™ Connect

Supported Settings	Amazon Alexa Voice Commands
Power	Turn on DEVICENAME
	Turn off DEVICENAME
Mode	Set DEVICENAME on manual
	Set DEVICENAME on auto
	Set DEVICENAME on adjustable speed
	Set DEVICENAME on adjustable humidity
Mist Spray Level	Change DEVICENAME spray level to one
	Change DEVICENAME spray level to two
	Change DEVICENAME spray level to three
	Change DEVICENAME spray level to four
	Change DEVICENAME spray level to five
Night Mode/Mood Light	Turn on light on the DEVICENAME
	Turn DEVICENAME light on
	Turn off light on the DEVICENAME
	Turn DEVICENAME light off

## Supported Settings

## Amazon Alexa Voice Commands

Warm Mist	Turn on heat on the DEVICENAME
	Turn DEVICENAME heat on
	Turn off heat on the DEVICENAME
	Turn DEVICENAME heat off
Humidity Level (30-90%)	Set DEVICENAME humidity to 30
	Set DEVICENAME humidity to 35
	Set DEVICENAME humidity to 40
	Set DEVICENAME humidity to 45
	Set DEVICENAME humidity to 50
	Set DEVICENAME humidity to 55
	Set DEVICENAME humidity to 60
	Set DEVICENAME humidity to 65
	Set DEVICENAME humidity to 70
	Set DEVICENAME humidity to 75
	Set DEVICENAME humidity to 80
	Set DEVICENAME humidity to 85
	Set DEVICENAME humidity to 90
ION (IONIZER)	Turn DEVICENAME ionizer on
	Turn DEVICENAME ionizer off



### NOTE

Currently, Amazon Alexa does not support the following settings:

- Timer.

## VOICE CONTROL WITH GOOGLE HOME/ASSISTANT:

Before you can voice control your Breville Smart Mist Top™ Connect with Google Home/Assistant, you need to link the Breville Home Connect™ account to the Google Home/Assistant app as per instructions.

## Google Home/Assistant Recommended Voice Commands for the Breville Smart Mist Top™ Connect

Supported Settings	Google Home/Assistant Voice Commands
Power	Turn on DEVICENAME
	Turn off DEVICENAME
Mode	Set DEVICENAME on manual
	Set DEVICENAME on auto
	Set DEVICENAME on adjustable speed
	Set DEVICENAME on adjustable humidity
Mist Spray Level	Change DEVICENAME spray level to one
	Change DEVICENAME spray level to two
	Change DEVICENAME spray level to three
	Change DEVICENAME spray level to four
	Change DEVICENAME spray level to five

Supported Settings	Google Home/Assistant Voice Commands
--------------------	--------------------------------------

Night Mode/Mood Light	Turn on light for DEVICENAME
	Turn DEVICENAME light on
	Turn off light for DEVICENAME
	Turn DEVICENAME light off
Warm Mist	Turn on heat for the DEVICENAME
	Turn DEVICENAME heat on
	Turn off heat for the DEVICENAME
	Turn DEVICENAME heat off
Humidity Level (30-90%)	Set DEVICENAME humidity to 30 percent
	Set DEVICENAME humidity to 35 percent
	Set DEVICENAME humidity to 40 percent
	Set DEVICENAME humidity to 45 percent
	Set DEVICENAME humidity to 50 percent
	Set DEVICENAME humidity to 55 percent
	Set DEVICENAME humidity to 60 percent
	Set DEVICENAME humidity to 65 percent
	Set DEVICENAME humidity to 70 percent
	Set DEVICENAME humidity to 75 percent
	Set DEVICENAME humidity to 80 percent
	Set DEVICENAME humidity to 85 percent
	Set DEVICENAME humidity to 90 percent
ION (IONIZER)	Turn DEVICENAME ionizer on
	Turn DEVICENAME ionizer off

 **NOTE**

Currently, Google Home/Assistant does not support the following settings:

- Timer.

 **TIPS for Amazon Alexa and Google Home/Assistant**

- Configure your Amazon Alexa or Google Home/Assistant compatible devices with the "Amazon Alexa" or "Google Home/Assistant" app if using, or simply download onto your phone.
- You will find your device listed as the Breville product name in your Breville Home Connect™ app account. Tap on the device in the app to rename your device for more convenient voice commands, e.g. "Humidifier Living Room" or give it a name, e.g. "Kenny".
- **Training your voice assistant - Voice Match-** Teach your assistant to recognise your voice. This isn't training it to understand English, but rather to recognise your voice as belonging to you. You can do this by going to the Settings menu in the voice assistant app on your mobile device.
- **Routines - Amazon Alexa and Google Home/Assistant** allow you to combine multiple actions in one voice command, to create a Routine, tap on the 'Routines' option via settings and follow the steps.
- Ensure the primary language is set to English (United States) for all apps.



## Care, Cleaning & Storage

Before cleaning, ensure the power is switched off and then remove the power plug from the power outlet.

### BREVILLE RECOMMENDS

- Only use cold water or distilled water in the water tank.
- Change the water often to keep it fresh.
- Clean the transducer, water tank and water basin at a minimum of once every week when in constant use.
- Use a small brush or a cotton swab to assist with cleaning the transducer and basin. Never use metal or sharp objects.
- After cleaning, ensure all parts are completely dry before using the humidifier.



### NOTE

Clean the whole humidifier and make sure that all parts are dried completely. Do not immerse the unit in water. Clean the transducer, water tank and basin at least once a week.



### IMPORTANT

If you do not use the humidifier for a long time, clean and dry the water tank and the water purification filter, and all parts before storage.



### WARNING

Do not use chemicals, steel wool, metal scouring pad or abrasive cleaners to clean the outside of the humidifier housing as these may damage the humidifier.



### IMPORTANT

Cleaning procedures must be routinely followed to ensure that the humidifier continues to operate efficiently. Do not use the humidifier unless it has been cleaned according to instructions.

### TO CLEAN EXTERNAL PARTS

- Use a clean, dry cloth to clean all external surfaces of the humidifier.
- A soft, slightly-damp cloth may be used to wipe the external housing of the humidifier if more thorough cleaning is required. Never use chemical substances or scourers as this could damage the housing and the control panel.
- Dry thoroughly before storing or using the humidifier.

### TO CLEAN INTERNAL PARTS

In cases when the water is hard (where water contains too much calcium and magnesium), leave heavy scale on the surface of the water basin, transducer and inner surface of the water tank. Scale, or calcification, on the surface of transducer will reduce the reliability of the unit. To clean internal parts of the humidifier, create a cleaning solution of 1-part vinegar to 1-part water.

### WATER TANK

- It is important to clean the water tank regularly and ensure it is dry before reassembling and using the humidifier.
- To clean, create a vinegar and water solution enough to fill the tank about half way. Swish the solution around for a minute, then fill the rest of the tank up with tap water. Leave to sit for 1-2 hours, or even overnight.
- Empty and rinse well with clean water.



### NOTE

To assist with emptying all the water from the water tank, it may help to slightly shake the tank over a sink or drain.

## MIST NOZZLE

- If the mist output is reducing due to calcification, turn the top cover over and immerse the nozzle in a vessel filled with vinegar and water solution and soak for at least 10 minutes.
- Rinse with clean or distilled water and allow to dry.

## WATER INLET BASIN

- The water inlet basin includes the water reservoir in the base of the unit that also houses the transducer and the heating plate.
- Clean the water basin with a soft cloth. If there is excess film or calcification on the surface, then soak the cloth with the vinegar and water solution and repeat the process.
- If there is film or calcification in any of the depressions along the basin, drop a bit of vinegar and water solution into the depression and lightly clean it with a brush or a cotton swab.
- Rinse with clean or distilled water and allow to dry.

## OPTIONAL CLEANING SOLUTION FOR CALCIFICATION ISSUES

- If a build-up of calcification on the transducer or heating plate occurs and cannot be removed with a simple vinegar and water solution, use a de-calcifying agent or citric acid.

## STRICTLY FOLLOW THE INSTRUCTIONS ON THE PACKAGING FOR THESE CLEANING PRODUCTS.

- Brush off any scale deposits from the transducer and heating plate surfaces using the brush or a cotton swab.
- Rinse with clean or distilled water and allow to dry.

## WARNING

Never use sharp or solid objects to clean the transducer and heating plate. Avoid touching the transducer and heating plate with your fingers.

## NOTE

The heating plate in the base of the humidifier will lose its stainless steel finish over time – this is normal. It is still recommended to de-calcify as per instructions noting that cleaning may not bring it back to its original shine.

## WATER PURIFICATION FILTER

It is recommended that you clean the water purification filter every time you clean the humidifier, especially if in frequent use. If the filter is cleaned regularly and as per instructions, it should last for the life of the humidifier.

1. Remove the cover from the top of the humidifier and set aside.
2. Using the handle, remove the water tank from the humidifier.
3. The water purification filter is connected to the water tank base. Unscrew the filter from the base to clean.

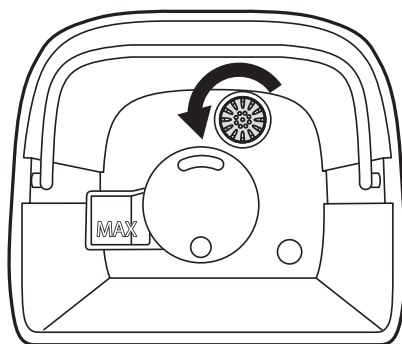

4. Dip the filter cartridge in a vinegar and water solution for about 10 minutes before thoroughly rinsing with clean water. Alternatively, rinse the filter under running tap water for a minute.

5. Once clean, place the filter in direct sunlight and allow to dry for at least an hour.
6. Reconnect the filter to the base of the water tank, then screw the filter onto the water tank.

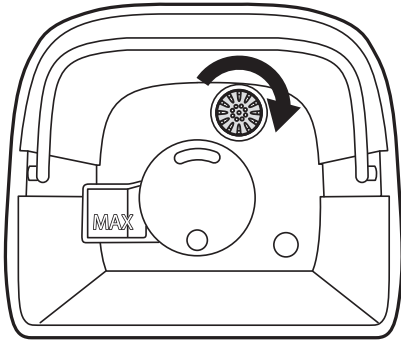

7. Use the water tank handle to carefully lower the tank into the humidifier.
8. Place the top cover on top of the water tank.

## STORAGE



- Never store the humidifier with water in the unit.
- Clean as per instructions and make sure that all parts are dry before storing.
- Allow the water tank and water inlet basin time to dry thoroughly before storing the humidifier.
- Keep the humidifier in a dry cool place.
- Do not place anything on top of the humidifier.



# Troubleshooting

## TROUBLESHOOTING GUIDE

Before carrying out any of the following service checks, unplug the unit from the mains.

PROBLEM	POSSIBLE CAUSES	WHAT TO DO
Power  red light is off or does not work.	<ul style="list-style-type: none"><li>• Humidifier is not plugged into the power outlet, the plug may be loose or the power outlet is not switched on.</li></ul>	<ul style="list-style-type: none"><li>• Check the power cord is connected to a power outlet and turned on.</li></ul>
Power  red light is on when switched on, but no mist comes out.	<ul style="list-style-type: none"><li>• Humidifier is not turned on.</li><li>• The target humidity has been reached.</li></ul>	<ul style="list-style-type: none"><li>• Press the power button to turn on.</li><li>• Increase the target humidity or change mode.</li></ul>
Water tank empty indicator  light is on.	<ul style="list-style-type: none"><li>• No water in the water tank.</li><li>• The water level is low.</li><li>• The water level required has not yet reached the vaporization compartment.</li><li>• The water tank isn't positioned correctly.</li><li>• The humidifier isn't on a flat surface.</li></ul>	<ul style="list-style-type: none"><li>• Refill the water tank and wait at least 1 minute.</li><li>• Wait at least 1 minute.</li><li>• Check the positioning of tank in the housing.</li><li>• Check the positioning of the humidifier.</li></ul>
The mist has a strange odour.	<ul style="list-style-type: none"><li>• When the humidifier is first used, there may be some residual odour that should dissipate.</li><li>• Water in the tank may be dirty or stagnant.</li><li>• Mineral scale has built up in the water inlet basin.</li><li>• Essential oil.</li></ul>	<ul style="list-style-type: none"><li>• This is normal for first use. If the smell does not dissipate, check water quality as below.</li><li>• Clean the water tank and refill with fresh, clean water.</li><li>• Clean as per instructions.</li><li>• If using the aroma feature, check that the essential oil used is not the cause of the odour and/or too much oil has been added.</li></ul>



<b>PROBLEM</b>	<b>POSSIBLE CAUSES</b>	<b>WHAT TO DO</b>
<b>Abnormal noise.</b>	• Vibration in the water basin because the water level is too low.	• Fill the water tank with clean water.
	• Humidifier is on an unstable surface.	• Move the humidifier to a stable flat surface.
	• Water tank is positioned incorrectly.	• Turn off and unplug the humidifier, then align the water tank cover with its respective opening in the inner chamber.
	• Humidifier is malfunctioning.	• Switch the unit off and contact the Breville Customer Service Centre.
<b>The humidification capacity is too low.</b>	• There is natural or artificial air replacement in the room which will interfere with the increase of %RH.	• Check if doors and windows are closed.
	• The air inlet grids and nozzle could be blocked.	• Check if there is no air conditioning working in the room.
	• Too much scale in the water basin.	• Remove any blocking items from the grids and the nozzle.
	• The humidity selected rate is too low.	• Clean transducer.
		• Increase mist output speed.
		• Increase humidity setting rate.
<b>The ambient humidity is too high.</b>	• Water is too dirty or water kept too long in the tank.	• Clean water tank, change to fresh clear water.
	• Humidifier is working in Manual mode.	• Change the mode.
	• The humidity target is too high.	• Select a lower %RH number.
	• Room is not well-ventilated.	• Open a window to ensure proper air flow for the humidifier, or move the humidifier to a more well-ventilated room.
	• Excess water from the water tank has spilled while filling the water tank or replacing the water tank back into the housing.	• Wipe off excess water from the top and bottom of the housing before replacing the water tank.
<b>Condensation in the room.</b>	• The room temperature is too low.	• Increase heat in the room up.
<b>The mist suddenly stops.</b>	• Programmed timer period has run out.	• Turn the humidifier back on.
	• The water empty indicator is on.	• Refill the water tank.
	• The target humidity level is reached.	• No action required.
<b>Adjustable Speed is not operating</b>	• The room humidity is higher than the selected humidity.	• Over-ride the set program.
<b>Does not operate, and 'EF' displays on the display screen</b>	• The water tank basin has too much water.	• Remove the filled water tank, then remove the excessive water from the water basin. Return the filled water tank and try again.

<b>PROBLEM</b>	<b>POSSIBLE CAUSES</b>	<b>WHAT TO DO</b>
Does not operate, and 'EO' displays on the display screen	<ul style="list-style-type: none"> <li>• A disconnection between the water sensor internal wiring.</li> </ul>	<ul style="list-style-type: none"> <li>• Switch the unit off and contact the Breville Customer Service Centre.</li> </ul>
Does not operate, and 'E1' displays on the display screen	<ul style="list-style-type: none"> <li>• The connection on the water sensor is loose.</li> </ul>	<ul style="list-style-type: none"> <li>• Switch the unit off and contact the Breville Customer Service Centre.</li> </ul>
Incorrect relative humidity level is displayed.	<ul style="list-style-type: none"> <li>• The room is larger than the effective range of the humidifier.</li> </ul>	<ul style="list-style-type: none"> <li>• Move the humidifier to a room which is within the recommended room size.</li> </ul>
	<ul style="list-style-type: none"> <li>• Moisture has built up inside of the humidity sensor.</li> </ul>	<ul style="list-style-type: none"> <li>• Turn off the humidifier and allow the humidity sensor to completely air dry before resuming use.</li> </ul>
	<ul style="list-style-type: none"> <li>• The nozzle is facing the direction of the humidity sensor.</li> </ul>	<ul style="list-style-type: none"> <li>• Turn the nozzle so it is facing away from the humidity sensor.</li> </ul>
	<ul style="list-style-type: none"> <li>• Humidity sensor is broken or defective.</li> </ul>	<ul style="list-style-type: none"> <li>• Switch the unit off and contact the Breville Customer Service Centre.</li> </ul>
Control panel does not work.	<ul style="list-style-type: none"> <li>• Hands are too wet when operating control panel.</li> </ul>	<ul style="list-style-type: none"> <li>• Keep hands dry while operating the control panel.</li> </ul>
	<ul style="list-style-type: none"> <li>• Humidifier has malfunctioned.</li> </ul>	<ul style="list-style-type: none"> <li>• Switch the unit off and contact the Breville Customer Service Centre.</li> </ul>
White dust appears around the humidifier.	<ul style="list-style-type: none"> <li>• Water being used has a high mineral content.</li> </ul>	<ul style="list-style-type: none"> <li>• Use distilled water with the humidifier. If distilled water is not available, use purified or filtered water. Clean the water tank at least once a week as per instructions in this book.</li> </ul>
	<ul style="list-style-type: none"> <li>• Humidifier was not properly cleaned after last use.</li> </ul>	<ul style="list-style-type: none"> <li>• Clean the humidifier as per instructions in this book.</li> </ul>
Mist is coming out from the base.	<ul style="list-style-type: none"> <li>• The water tank isn't positioned correctly in the housing.</li> </ul>	<ul style="list-style-type: none"> <li>• Check the positioning of tank.</li> </ul>
Mist fog coming out from around nozzle or water is leaking from the lid.	<ul style="list-style-type: none"> <li>• The nozzle is not correctly fitted.</li> </ul>	<ul style="list-style-type: none"> <li>• Reposition the cover and check if the nozzle is plugged in correctly.</li> </ul>
The warm mist function does not produce warm mist.	<ul style="list-style-type: none"> <li>• The humidifier is still warming up.</li> </ul>	<ul style="list-style-type: none"> <li>• Wait a few minutes before checking again.</li> </ul>
	<ul style="list-style-type: none"> <li>• The mist is too fine to feel the warmth.</li> </ul>	<ul style="list-style-type: none"> <li>• Increase the mist level.</li> </ul>
	<ul style="list-style-type: none"> <li>• The room temperature is too cold and the mist may cool down too quickly.</li> </ul>	<ul style="list-style-type: none"> <li>• Increase the mist level and heat the room.</li> </ul>
Remote control is not working.	<ul style="list-style-type: none"> <li>• Remote control is out of range of the humidifier.</li> </ul>	<ul style="list-style-type: none"> <li>• Use the remote control within 5m of the humidifier.</li> </ul>
	<ul style="list-style-type: none"> <li>• The plastic tab is still in.</li> </ul>	<ul style="list-style-type: none"> <li>• Remove the plastic tab from the battery compartment.</li> </ul>
	<ul style="list-style-type: none"> <li>• Battery needs to be changed.</li> </ul>	<ul style="list-style-type: none"> <li>• Replace the battery.</li> </ul>

## TROUBLESHOOTING GUIDE FOR AMAZON ALEXA AND GOOGLE HOME/ASSISTANT

PROBLEM	WHAT TO DO
Why is Amazon Alexa or Google Home/Assistant not responding to my voice commands.	<ul style="list-style-type: none"><li>• Check the internet connection.</li><li>• Restart your device &amp; mobile phone.</li><li>• Restart your modem and router.</li><li>• Make sure your Amazon Alexa or Google-enabled device or mobile phone is in Wi-Fi range.</li><li>• When you are giving a command to Amazon Alexa or Google Home/Assistant make sure you are clear and there is no unwanted noise in the background.</li><li>• While the voice assistant is always on in the background, only an activation phrase will allow for the voice assistant to start. registering the commands being relayed. The activation phrase depends on the application being used; For Amazon Alexa, use “Alexa”, while “OK Google” is for Google Home/Assistant.</li><li>• Ensure your voice is clear and distinct to allow the assistant to accurately record and process the command.</li><li>• Ask direct questions. Refer to the commands list for recommended commands.</li></ul>

If the problem is not listed, please contact Breville Customer Service Centre (see back cover for contact details)

## Breville Customer Service Centre

### **Australian Customers**

**Phone:** 1300 139 798

**Web:** [www.breville.com](http://www.breville.com)

### **New Zealand Customers**

**Phone:** 0800 273 845

**Web:** [www.breville.com](http://www.breville.com)

# **Breville®**

**Master Every Moment™**

Breville, the Breville logo, Master Every Moment, SensAir System, Smart Mist Top and Breville Home Connect are trademarks of Breville Pty. Ltd. A.B.N. 98 000 092 928.

Copyright Breville Pty. Ltd. 2021

All other brands may be trademarks of their respective owners.

Due to continued product improvement, the products illustrated/photographed in this booklet may vary slightly from the actual product.