

*the Smart Air™ Viral Protect
Night Glow Purifier*

Instruction Book - LAP168



Breville®



Contents

- 2 Breville Recommends Safety First
- 6 Components
- 7 Control Panel
- 8 Features
- 8 Assembly
- 9 Functions
- 11 Wi-Fi Connectivity
& Voice Assistants
- 14 Care, Cleaning & Storage
- 16 Troubleshooting

BREVILLE RECOMMENDS SAFETY FIRST

At Breville we are very safety conscious. We design and manufacture consumer products with the safety of you, our valued customer, foremost in mind. In addition, we ask that you exercise a degree of care and adhere to the following precautions.

SPECIFICATIONS

| | |
|-------------------|--------------------------------------------------------|
| Filter Life | 12 months based on 12 hours daily operation or 4320hrs |
| Product Dimension | 194 x 321mm |
| For Room Size | Up to 28m ² |
| Noise Level | 30-60dB |
| Power Consumption | 12W |
| Weight | 2kg |
| CADR | 110m ³ /h |
| OS Compatibility | Android® 5.0 or later and iOS 11 or later |

IMPORTANT SAFEGUARDS

READ ALL INSTRUCTIONS BEFORE USE AND SAVE FOR FUTURE REFERENCE

- Remove and safely discard any packaging material and promotional labels before using the air purifier and filter for the first time.
- To eliminate a choking hazard for young children, remove and safely discard the protective cover fitted to the power plug of this air purifier.
- When unpacking the air purifier, check to see you have received all the items listed in the parts list, before discarding the packaging.
- This air purifier is intended for household use only and not for commercial or industrial use.
- Do not use outdoors.
- Always ensure the air purifier is properly assembled before use. Follow the instructions provided in this book.
- Do not place the air purifier near the edge of a bench or table during operation. Ensure the surface is level, clean and free of water.

- Keep the power cord out of heavy traffic areas. To avoid fire hazard, never put the cord under rugs, near heat registers, radiator, stoves or heaters.
- To protect against electrical hazards, do not immerse in water or other liquids. Do not use the air purifier in the immediate surroundings of a bath, a shower or a swimming pool.
- Children should be supervised to ensure they do not play with the air purifier.
- Always turn off and unplug the air purifier before moving, opening the grill, changing filters, cleaning or whenever the air purifier is not in use.
- Do not unplug the air purifier by pulling on the power cord. Always unplug using the power plug.
- Never insert fingers, pencils or any other objects through the guards whenever the power plug is connected, in particular, while the air purifier is switched on.
- Do not run the power cord under carpeting or cover the power cord with rugs, runners or the like. Arrange the power cord away from traffic areas and where it will not be tripped over.
- Do not route power cord under furniture or appliances.
- Do not operate the air purifier with a damaged power cord or plug, or if the air purifier has been dropped or damaged in any manner. Take the air purifier to your nearest Breville service centre for examination, electrical or mechanical adjustment or repair.
- Do not use the air purifier with an external timer, programmer or any other device that switches the air purifier on automatically since a fire risk may exist if the air purifier is covered or positioned incorrectly.
- Do not place anything on top of the air purifier when assembled, when in use and when stored.
- Never block the air openings, grills/outlets or place on a soft surface such as a bed or sofa, as this could cause the unit to tip over, blocking the air inlet or outlet opening.

- Do not attempt to repair or adjust any electrical or mechanical functions on this unit. Doing so will void your warranty. Other than the filter, the inside of the unit contains no user serviceable parts. All servicing should be performed by qualified personnel only.
- Keep the air purifier and dust filters clean. Follow the cleaning instructions provided in this book.

IMPORTANT SAFEGUARDS FOR ALL ELECTRICAL APPLIANCES

- Fully unwind the power cord before use.
- Connect only to a 230V or 240V power outlet.
- Do not let the power cord hang over the edge of a bench or table, touch hot surfaces or become knotted.
- To protect against electric shock, do not immerse the power cord, power plug or appliance in water or any other liquid or allow moisture to come in contact with the part, unless it is recommended in the cleaning instructions.
- The appliance is not intended for use by persons (including children) with reduced physical, sensory or mental capabilities, or lack of experience and knowledge, unless they have been given supervision or instruction concerning use of the appliance by a person responsible for their safety.
- Children should be supervised to ensure that they do not play with the appliance.
- It is recommended to regularly inspect the appliance. To avoid a hazard, do not use the appliance if power cord, power plug or appliance becomes damaged in any way. Return the entire appliance to the nearest authorised Breville Service Centre for examination and/or repair.
- Any maintenance other than cleaning should be performed at an authorised Breville Service Centre.

- This appliance is for household use only. Do not use this appliance for anything other than its intended use. Do not use in moving vehicles or boats. Do not use outdoors.
Misuse may cause injury.
- The installation of a residual current device (safety switch) is recommended to provide additional safety protection when using electrical appliances. It is advisable that a safety switch with a rated residual operating current not exceeding 30mA be installed in the electrical circuit supplying the appliance. See your electrician for professional advice.
- During electrical storms, the appliance should be disconnected from the power source at the wall socket to prevent any electrical surges that may arise during the storm and which may inadvertently cause damage to the appliance and its electronic componentry.
- Always turn the appliance to the off position, switch off at the power outlet and unplug at the power outlet when the appliance is not in use.
- Before cleaning, always turn the appliance to the off position, switch off at the power outlet, unplug at the power outlet and remove the power cord, if detachable, from the appliance and allow all parts to cool.
- Do not place this appliance on or near a heat source, such as hot plate, oven or heaters.
- Position the appliance at a minimum distance of 20cm away from walls, curtains and other heat or steam sensitive materials and provide adequate space above and on all sides for air circulation.
- Never use substance other than essential oil in aroma tray.

**FOR HOUSEHOLD USE ONLY
SAVE THESE INSTRUCTIONS**



Components

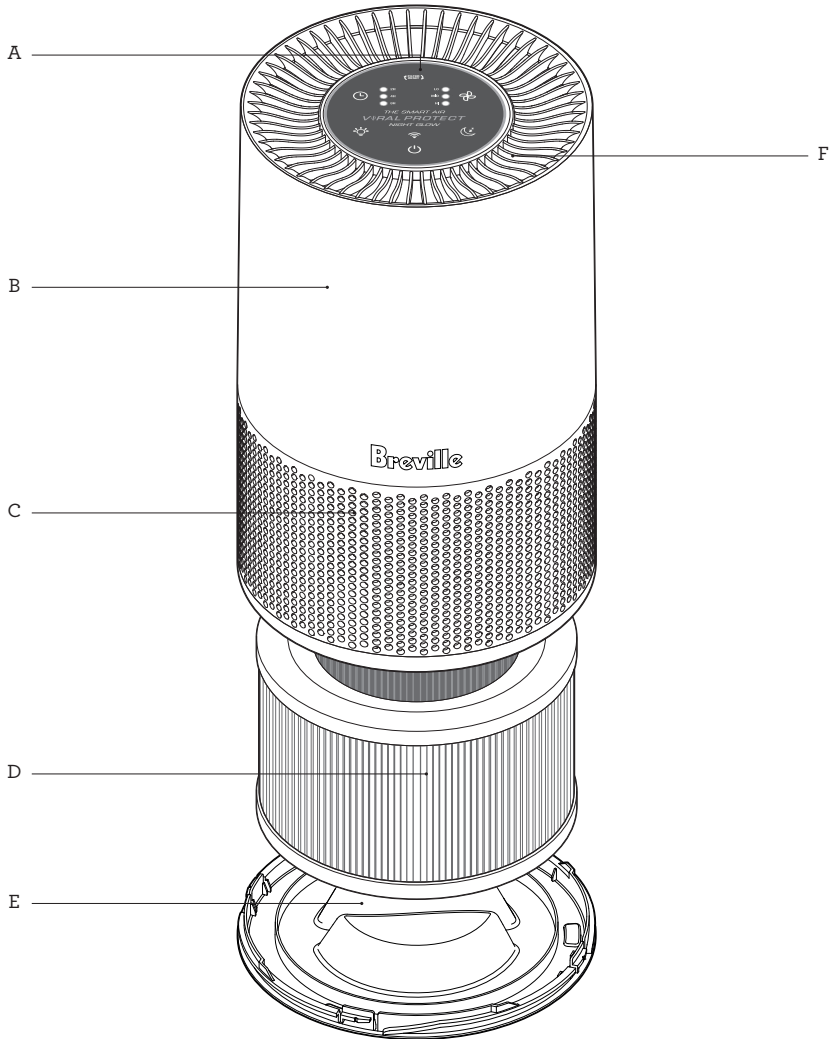

- A. Control Panel
 - B. Main Housing Body
 - C. Air Inlet
 - D. 3-Layer HEPA-13 AntiViral Filter
 - E. Base
 - F. Air Outlet
- NOT PICTURED**
- Adaptor Inlet Socket
 - Adaptor
 - Aroma Tray + Pad



Control Panel

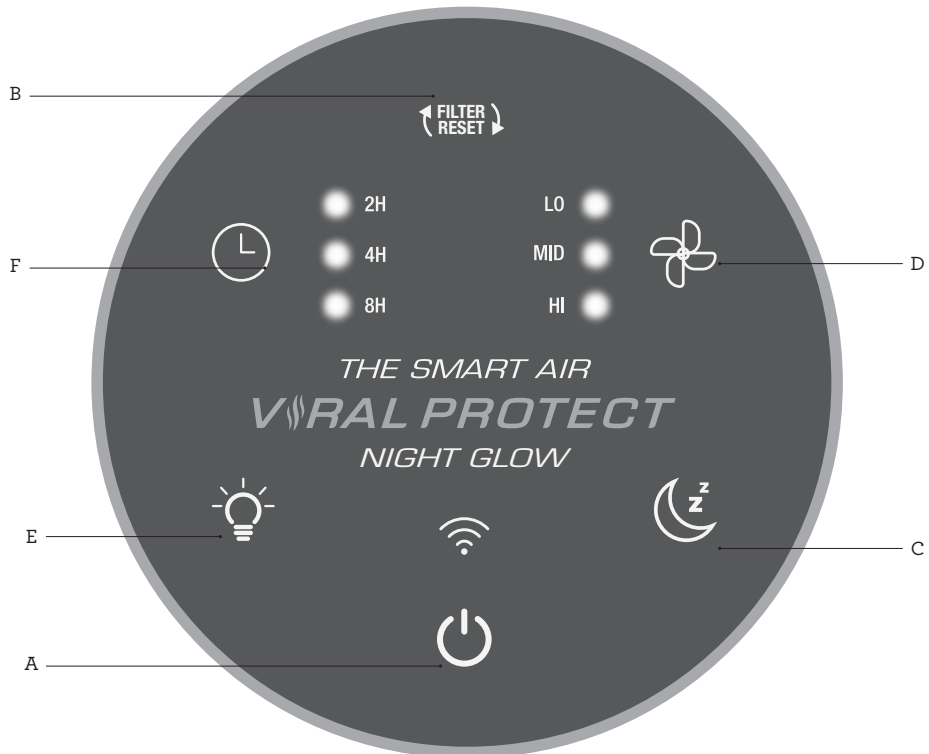

A. Power On/Off and Wi-Fi

B. Filter Reset

C. Night Mode

D. Fan Speed

(Includes 3 speed modes; Low, Medium, High)

E. Night/Mood Light

7 night light colours to choose from

F. Timer

(2h, 4h, 8h)



Features

YOUR BREVILLE AIR PURIFIER

Your Breville Purifier improves your indoor air quality using 3 distinct levels of protection built into the Breville AntiViral Filter including:

1. Pre-filter
For dust & pet dander.
 2. AntiViral HEPA-13 filter
For fine airborne particles, allergens and virus reduction including SARS-CoV-2 viral particles and H1N1 & H3N2 particles.
 3. Activated carbon filter
For odours and smoke.
- Reduces 99.97% SARS-CoV-2 and 99.99% Influenza A viral particles[^]
 - Removes 99.97% of smoke, pollen & dust particles down to 0.3 m

- [^]The AntiViral filter material is tested for the reduction of SARS-CoV-2, H1N1 and H3N2 viral particles as per ISO 18184.



Assembly

BEFORE FIRST USE

- Remove and safely discard any packaging material or promotional labels attached to your air purifier and filter.
- Remove the filter from the air purifier (see REPLACING THE FILTER on page 12) and take it out of the plastic bag. Then re-insert the filter into the air purifier.
- Select a flat and level location for the air purifier.
- For proper air flow, locate the unit at least 20cm from any wall or furniture.
- Ensure the air inlet and outlets are not blocked before use.
- Ensure the filter has been fitted correctly as per the instructions in this book.
- Plug the adaptor into a 230V-240V power outlet and connect to the adaptor inlet of the air purifier. Turn on the power outlet.



IMPORTANT

When moving the air purifier, always lift the unit using two hands and set down gently on a flat and level surface.





IMPORTANT

Do not use any other adapter other than the one provided with the unit.





Functions



OPERATING YOUR AIR PURIFIER

1. Press the  POWER button to turn on and the  POWER symbol light will illuminate.
2. The air purifier will begin operation.
3. The air purifier will begin operation in the last setting selected.
4. To adjust how the air purifier operates, follow the directions below.

NIGHT MODE

- To turn on night mode, press the  button until the Night icon starts to blink.
 - After 5 blinks, all indicator lights on the control panel will turn off as the unit enters night mode and the fan speed will automatically change to lower than the lowest fan speed.
- Press the  or  POWER button again to turn the lights back on.

NIGHT/MOOD LIGHT

- This Breville purifier has the added feature of a night/mood light with 7 colours to choose from.
- To choose a night/mood light colour, press the  repeatedly to toggle between the colours.
- The indicator lights on the control panel will remain on.
- Press the  button on the control panel repeatedly until the light extinguishes.
- To change the brightness of the mood light colour chosen, press and hold the night/mood light button until the brightness changes. Repeat if desired for other brightness options.
- If this unit is paired with the Breville Home Connect App, and the night/mood light is activated via the unit, the light icon will illuminate on the Breville Home Connect™ app screen to indicate to the user that the night/mood light has been turned on.

Note, the chosen mood light color selected via the unit will not display on the colour wheel found on the app.

- If the night/mood light is controlled via the Breville Home Connect app, colours displayed on the colour wheel can be chosen. There are many colours to choose from when controlling this unit via the Breville Home Connect App that cannot be selected on the unit itself.

FAN SPEED



NOTE

The air purifier will resume in the last programmed setting once it has been turned off, except for Night mode and timer settings. If the air purifier is turned off at the power outlet, the memory will reset back to default.

- Press the  FAN SPEED button repeatedly until the desired speed is illuminated on the control panel.
- There are 3 fan speeds: Low, Medium and High.



NOTE

When changing the fan speed, the unit may take a few seconds to adjust.

TIMER

- The air purifier can be set to operate for timed intervals of 2 hours, 4 hours and 8 hours, stopping automatically when the selected operating time has elapsed.
- If no timer is set, the air purifier will continuously operate until the unit is manually switched off.
- Press the  TIMER button repeatedly until the desired interval hours are illuminated on the control panel.

- For continuous operation, press the  TIMER button repeatedly until there are no lights illuminated under the timer intervals.

FILTER RESET

- The filter reset light will illuminate red indicating that the filter needs to be replaced.
- Replace the filter according to the directions found under Replacing the Filter in this book.
- Once the filter is replaced, press and hold  for 3 seconds to reset the Filter Reset light.
- The built-in timer for the filter reset is 4,320 operating hours.



NOTE

For best performance, the filter should be cleaned at least monthly as per the instructions found in the Care, Cleaning & Storage section of this book.

AROMA TRAY

- Press the aroma tray on the side of the purifier and it will click out of the unit.
- Add 2-3 drops of essential oil (not included) directly to the pad in the aroma tray.
- Push the aroma tray back into the purifier until it clicks into place.
- Turn the purifier on and the aroma will start emitting automatically with the fan. Increase the fan level as desired.



WARNING

Never add essential oil directly inside the unit or in the aroma tray without the felt pad. Do not use more than 2-3 drops of oil on the aroma tray felt pad at any one time. Only add more oil when the aroma in the surrounding air has dissipated.



Wi-Fi Connectivity

This Breville Home connected product can be controlled both through Wi-Fi and Bluetooth. While Wi-Fi allows for connectivity and control remotely, Bluetooth allows for control within range of the product, even without Wi-Fi.

Your Breville Purifier can offer remote operation by using a home Wi-Fi connection and the Breville Home Connect™ app downloaded to a compatible mobile phone through the Google Play store or Apple App store.

To go straight to the appropriate app store, scan the QR code below.



For instructions on how to use the app, scan the QR code below, refer to the Quick Start Guide that can be found in the box or go to tinyurl.com/HomeConnectQuickStart.



NOTE

The Breville Home Connect™ app is compatible with mobile phones running Android® 5.0 or later and iOS devices 11 or later.





NOTE

To control the purifier using the app, the purifier must be plugged into an active power outlet.



CONNECT YOUR PURIFIER TO WI-FI

Choose from the options available to allow for easy pairing and use.

Bluetooth connection has also been activated for this appliance, which will aid in the pairing process, providing a higher success rate when pairing.

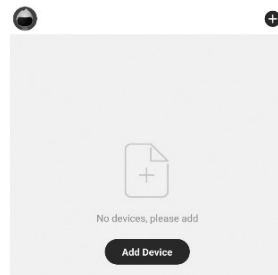
1. Ensure the mobile device is connected to a home Wi-Fi network.
2. Once on standby mode, the  symbol will flash fast on the display panel. The air purifier is now ready to connect.
3. Log into your Breville Home Connect™ app account and stay on the “Home” page. To add the purifier to the list, touch ‘Add Device’ or the  symbol found in the top right-hand corner of the screen. Follow the prompts in the app.



4. If the connection is successful, the purifier will appear in the main page of the app and the  symbol on the purifier will illuminate.
5. If connection is unsuccessful, touch and hold the  button for 5 seconds until the  light is flashing slowly. Follow the prompts in the app to connect in a different mode.

BLUETOOTH

Bluetooth connectivity is an added feature of Breville Home connected purifiers and other Breville Bluetooth connected products.

Flashing  indicates connectivity pairing with the purifier and the Breville Home Connect™ app. Pairing is quick with no extra prompts. Refer to the QuickStart Guide in the box or on Breville.com for specific details on how to connect through Bluetooth.



Voice Assistance

Breville Purifier comes with the added feature of voice assistance, allowing control using voice activation by linking your Breville Home Connect™ app with Amazon Alexa and Google Home/Assistant.

To link your Breville Home Connect™ app account with either Google Home/Assistant or Amazon Alexa, refer to the instructions on www.Breville.com or follow instructions found in the Breville Home Connect™ app under **Me > Third-Party Voice Services > View more ways to link.**



IMPORTANT NOTE

The recommended voice commands to operate the appliance's functions differ between Amazon Alexa and Google Home/Assistant as listed. Variations of these commands may also be recognised, however, if a command fails, check against the recommended voice command.



NOTE

To control the purifier using the Amazon Alexa or Google Home/Assistant app, it must be plugged in to an active power outlet and turned on.

VOICE CONTROL WITH AMAZON ALEXA

Before activating voice control with Amazon Alexa, link the Breville Home Connect™ account to the Amazon Alexa app as per the instructions.

Amazon Alexa Recommended Voice Commands:

| Supported Settings | Amazon Alexa Voice Commands |
|--------------------|-------------------------------------|
| Power | Turn ON DEVICENAME |
| | Turn OFF DEVICENAME |
| Mode | Set DEVICENAME to manual mode |
| | Set DEVICENAME to night mode |
| Fan Speed | Set DEVICENAME fan speed to Level 1 |
| | Set DEVICENAME fan speed to Level 2 |
| | Set DEVICENAME fan speed to Level 3 |
| Night Light | Turn ON night light |
| | Turn OFF night light |



NOTE

Currently, Amazon Alexa does not support the following settings:
Timer, Night/Mood Light Colour and Filter Reset.

VOICE CONTROL WITH GOOGLE HOME/ASSISTANT

Before activating voice control with Google Home/Assistant, link the Breville Home Connect™ account to the Google Home/Assistant app as per the instructions.

Google Recommended Voice Commands:

| Supported Settings | Google Home/Assistant Voice Commands |
|--------------------|--------------------------------------|
| Power | Turn ON DEVICENAME |
| | Turn OFF DEVICENAME |
| Mode | Set DEVICENAME to manual mode |
| | Set DEVICENAME to night mode |
| Fan Speed | Set fan speed to low on DEVICENAME |
| | Set fan speed to mid on DEVICENAME |
| | Set fan speed to high on DEVICENAME |
| Night Light | Turn ON night light |
| | Turn OFF night light |



NOTE

Currently, Google Home/Assistant does not support the following settings:
Timer, Night/Mood Light Colour and Filter Reset.



TIPS for Amazon Alexa and Google Home/Assistants

- Configure Amazon Alexa or Google Home/Assistant compatible devices with the "Alexa" or "Google Home/Assistant" app if using, or simply download onto your phone.
- You will find your device listed as the Breville product name in your Breville Home Connect™ app account. Tap on the device in the app to rename your device for more convenient voice commands, e.g. "Purifier Living Room" or give it a name, e.g. "Kenny".
- **Training your voice assistant - Voice Match** - Teach your assistant to recognise your voice. This isn't training it to understand English, but rather to recognise your voice as belonging to you. You can do this by going to the Settings menu in the voice assistant app on your phone.
- **Routines - Amazon Alexa and Google Home/Assistant** allow you to combine multiple actions in one voice command, to create a Routine, tap on the 'Routines' option via settings and follow the steps.
- Ensure the primary language is set to English (United States) for all apps.



Care, Cleaning & Storage

The air purifier and filter should be cleaned at least once every month. Ensure the air purifier is switched off and disconnected from the power outlet before cleaning or storing.

- Use a clean, dry cloth to clean all external surfaces of the air purifier.



NOTE

More frequent cleaning may be required depending on environmental conditions.

BREVILLE RECOMMENDS

- Always ensure the air purifier is turned off, switched off at the power outlet and unplugged before performing any cleaning or filter replacement.
- ✗ **DO NOT** stick any foreign objects or your fingers inside the air inlet/outlet of this unit.
- ✗ **DO NOT** use gasoline, benzine, thinner, harsh cleaners, etc. on and/or in the unit while cleaning as they will damage the unit.
- ✗ **NEVER** use alcohol or other solvents on this unit.

FILTER CLEANING AND REPLACING



WARNING

The filter is not washable. Do not immerse any part of the air purifier in water as it will cause damage.

- The Pre-filter should be cleaned at least once every month using a vacuum cleaner. Gently vacuum using a hand-tool attachment such as a brush or upholstery tool. Clean more often if required.
- Do not use any solutions, hard bristle brushes or sharp objects to clean as this can cause damage.
- Replace the filter as indicated using the instructions following.

REPLACING THE FILTER

Your Smart Air™ Viral Protect Night Glow Purifier filter should be replaced in the time frames indicated below.

- The filter life is approximately 12 months based on daily operation of 12 hours per day or 4320hrs in total*.
- Recommended replacement every 6 to 12 months, or 4320 hours, depending on severity of symptoms/sensitivity levels, frequency of use and air quality. More frequent replacements will provide optimal benefits.
- The filter life may vary to this timing, depending on environmental conditions.
- Remove all packaging from the replacement filter and place the filter into the unit as described below.

1. Carefully turn your air purifier upside down and turn the base anti-clockwise to remove the base from the unit.
2. Remove the used filter, being careful that any residue or debris that may fall from the filter will not cause damage.
3. Insert the replacement filter into the unit, ensuring that it is correctly fitted and centred.
4. Replace the base and turn clockwise to secure.
5. Return the air purifier to an upright position.
6. Turn on the air purifier then press and hold the  POWER button for 5 seconds to reset the Filter Reset light.



NOTE

There is no top or bottom on the filter. The filter can be placed into the unit either way.



NOTE

If the filter is not in place or not fitted correctly, the air purifier will not operate.

REPLACEMENT FILTERS

Replacement filters must be purchased from the Breville website[^] or at participating retail outlets.

See the table below for the replacement product code to suit this Breville Air Purifier.

| Breville Air Purifier Model No. | Filter Replacement Product Code |
|---------------------------------------------------------|------------------------------------|
| the Smart Air™ Viral Protect Night Glow LAP168WHT | LAP010BLU |

[^]Delivery charges may apply.

Please contact Breville Customer Service Centre for further support.

Only use the original Breville filter specially intended for this appliance. Do not use any other filters.



Troubleshooting

MINI TROUBLESHOOTING GUIDE

Before carrying out any of the following service checks, unplug the unit from the mains.

| PROBLEM | WHAT TO DO |
|-------------------------------|-----------------------------------------------------------------------------------------------------------------------------------------------------------------------------------------------------------------------------------------------------------------------------------------------------------------------------------------------------------|
| Unit will not start. | <ul style="list-style-type: none">• Check that the power plug is connected to a power outlet and the outlet is turned on.• Check that air purifier is assembled correctly.• Check that the filter is fitted correctly in place. |
| Insufficient air flow. | <ul style="list-style-type: none">• Check that the filters are clean.• Check for any obstructions in the air inlet and/or outlet. |
| Excessive noise. | <ul style="list-style-type: none">• Check for any foreign objects that may be in contact with the fan.• Check if the filter is clogged and ready for replacement.• Check that the air purifier has been assembled correctly and the locking knob has been tightened.• Check that the unit is on a level surface. |

TROUBLESHOOTING GUIDE FOR AMAZON ALEXA AND GOOGLE HOME/ASSISTANT

| PROBLEM | WHAT TO DO |
|-----------------------------------------------------------------------------------|-------------------------------------------------------------------------------------------------------------------------------------------------------------------------------------------------------------------------------------------------------------------------------------------------------------------------------------------------------------------------------------------------------------------------------------------------------------------------------------------------------------------------------------------------------------------------------------------------------------------------------------------------------------------------------------------------------------------------------------------------------------------------------------------------------------------------------------------------------------------------------------------------------------------------------------------------------------------------------------|
| Why is Amazon Alexa or Google Home/Assistant not responding to my voice commands. | <ul style="list-style-type: none">• Check the internet connection.• Restart your device & mobile phone.• Restart your modem and router.• Make sure your Amazon Alexa or Google-enabled device or mobile phone is in Wi-Fi range.• When you are giving a command to Amazon Alexa or Google Home/Assistant make sure you are clear and there is no unwanted noise in the background.• While the voice assistant is always on in the background, only an activation phrase will allow for the voice assistant to start. registering the commands being relayed. The activation phrase depends on the application being used; For Amazon Alexa, use “Alexa”, while “OK Google” is for Google Home/Assistant.• Ensure your voice is clear and distinct to allow the assistant to accurately record and process the command.• Ask direct questions. Refer to the commands list for recommended commands. |

If the problem is not listed, please contact Breville Customer Service Centre (see back cover for contact details)

Breville Customer Service Centre

Australian Customers

Phone: 1300 139 798

Web: www.breville.com

New Zealand Customers

Phone: 0800 273 845

Web: www.breville.com

Breville®

Master Every Moment™

Breville, the Breville logo, Master Every Moment, Smart Air and the Microbe Shield logo are trademarks of Breville Pty. Ltd. A.B.N. 98 000 092 928.
Copyright Breville Pty. Ltd. 2021.

All other brands may be trademarks of their respective owners.

Due to continued product improvement, the products illustrated/photographed in this booklet may vary slightly from the actual product.

LAP168 ANZ B23