



MODELS

WHS642WA, WHS642SA
CHS642WA, CHS642SA
CHS942WA

SOLID ELEMENT COOKTOPS

User and Installation Manual

CONGRATULATIONS

Dear customer,

Congratulations on the purchase of your new cooktop.

Before you use the cooktop, we recommend that you read through the whole user manual which provides the description of the cooktop and its functions.

To avoid the risks that are always present when you use an electrical appliance, it is important that the cooktop is installed correctly and that you read the safety instructions carefully to avoid misuse and hazards.

We recommend that you keep this instruction booklet for future reference and pass it on to any future owners.

After unpacking the appliance, please check it is not damaged. If in doubt, do not use the appliance but contact your local Customer Care Centre.

For contact details, refer to the last page of this user manual. This appliance complies with requirements of Australian Standard AS/NZS 60335.2.6

Conditions of use

This appliance is intended to be used in household and similar applications such as:

- Staff kitchen areas in shops, offices and other working environments
- Farm houses
- By clients in hotels, motels and other residential type environments
- Bed and breakfast type environments

Please ensure you read the instruction manual fully before you call for service, or a full service fee could be applicable.

Record model and serial number here:

Model:

Serial number:

CONTENTS

Important safety instructions	3
Product description	4
Operating instructions	8
Helpful hints and tips	12
Care and cleaning	13
Troubleshooting	14
Technical data	15
Environment concerns	15
Installation instructions	16
Assembly	17
Warranty	19

Please read the user manual carefully and store in a handy place for later reference.

The symbols you will see in this booklet have these meanings:

warning

This symbol indicates information concerning your personal safety.

caution

This symbol indicates information on how to avoid damaging the appliance.

important

This symbol indicates tips and information about use of the appliance.

environmental tips

This symbol indicates tips and information about economical and ecological use of the appliance.

general safety

warning

Please comply with these instructions. If you do not, any damage resulting is not covered by the warranty.

General safety

- This appliance is not intended for use by persons (including children) with reduced physical, sensory or mental capabilities, or lack of experience and knowledge, unless they have been given supervision or instruction concerning use of the appliance by a person responsible for their safety.
- Do not leave the appliance unattended during operation.
- This appliance should be used only for normal domestic cooking and frying of food.
- The appliance must not be used as a work surface or as a storage surface.
- Additions or modifications to the appliance are not permitted.
- Do not place or store flammable liquids, highly inflammable materials or fusible objects (e.g. plastic film, plastic, aluminium) on or near the appliance.
- Danger of fire: Do not store items on the cooking surface

Children's safety

- The cooking zones will become hot when you cook. Therefore, always keep small children away from the appliance.
- The appliance is not intended for use by young children or infirm persons without supervision.
- Children should be supervised to ensure that they do not play with the appliance.

warning

Accessible parts will become hot during use. To avoid burns young children should be kept away

Correct operation

- Always monitor the appliance during operation. Do not use an external timer or a separated remote control system to operate the appliance.
- Only use the appliance for domestic cooking tasks..
- Do not use the appliance as a work or a storage surface.
- Do not put or keep very flammable liquids and materials, or fusible objects (made of plastic or aluminium) on or near the appliance.
- Other than the connection point in the terminal block, do not let the electrical supply cord touch the appliance or hot cookware. Ensure electrical supply cord is not tangled.

General safety

- The appliance may only be installed and connected by trained, registered service engineers.
- Built-in appliances may only be used after they have been built into suitable built-in units and work surfaces that meet standards.
- In the event of faults with the appliance, the appliance must be switched off and disconnected from the electrical supply, to prevent the possibility of an electric shock.

- Repairs to the appliance must only be carried out by trained registered service engineers.

Safety during use

- Remove stickers and film from the glass ceramic.
- There is the risk of burns from the appliance if used carelessly.
- Cables from electrical appliances must not touch the hot surface of the appliance or hot cookware.
- Overheated fats and oils can ignite very quickly. Warning! Fire hazard!
- Switch the cooking zones off after each use.

caution

The cooking process has to be supervised. A short term cooking process has to be supervised continuously.

warning

Unattended cooking on a hob with fat or oil can be dangerous and may result in a fire.

Where the appliance is built into a cabinet, the cabinet material must be capable of withstanding 85°C.

Only authorised personnel should carry out servicing. (Certificate of Compliance to be retained)

- This appliance must be earthed.
- The fixed wiring insulation must be protected, for example, by insulating sleeving having an appropriate temperature rating.
- Before using the appliance, ensure that all packing materials are removed from the appliance.
- During use, this appliance becomes hot. Care should be taken to avoid touching hot surfaces.
- This appliance must not be used as a space heater.
- In order to avoid a fire, the appliance must be kept clean and vents kept unobstructed.
- Do not spray aerosols in the vicinity of the appliance when it is operated.
- Do not store flammable materials in or under the appliance, e.g. Aerosols.
- Do not allow pots to boil dry, as damage to both pan and cooktop may result.
- Do not operate the cooktop for an extended period of time without a utensil on the hotplate.
- Do not allow large cookware to overhang the cooktop onto the adjacent benchtop. This will cause scorching to the benchtop surface.
- In order to avoid any potential hazard, the enclosed installation instructions must be followed.
- Always ensure the appliance is switched off and cool before cleaning or replacing parts.
- Do not use steam cleaners, as this may cause moisture build up.

helpful hints and tips

Fig. 3

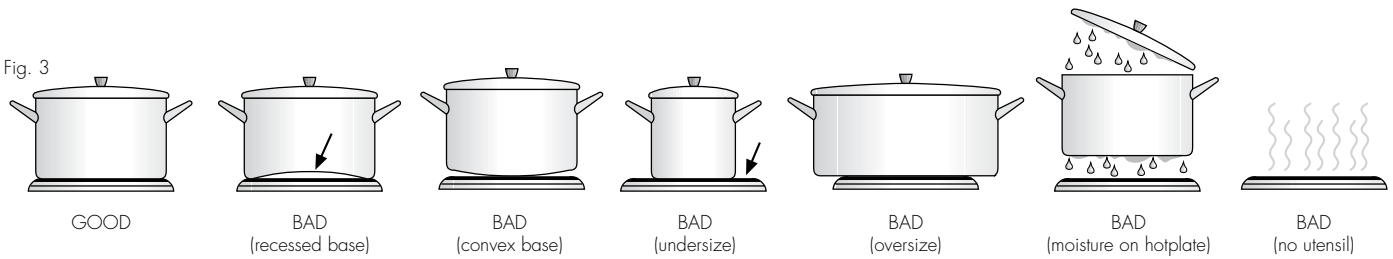

Hotplates

Coated solid hotplates are strong, and give a good contact with flat bottom pots and pans for fast efficient cooking. The hotplates are sealed all round with stainless steel trim rings, food spills can't penetrate to make cleaning easier. It is normal for stainless steel trim rings to discolour with use over time.

The hotplates include a red dot in the centre to indicate the hotplate temperature, once the hotplate is heated the red dot turns to black.

Utensils (Fig. 3)

- Use pans with flat bottoms. Uneven or thin bottoms will increase cooking time especially when boiling. Not suitable for curved base wok or pan.
- Use pans slightly larger than hotplates. Smaller pans will waste energy.
- Do not use oversize pans. More than 50mm overhang can overheat cooktop components and cause fine cracks in the enamel hob which will trap dirt. This may also discolour stainless steel hobs.
- Do not place wet pots or pans on the hotplates.
- Do not use pots and pans that are unsteady and likely to rock or over balance.
- Do not operate the cooktop for an extended time without a pot or pan on the hotplate, it will cause damage to the cooktop.

Cooking Do's and Dont's

- Do use the stored heat in the hotplate by turning the control to 'O' before the final few minutes of cooking.
- Do not place heat resistant mats, wire mats or aluminium foil under pots and pans.
- Do not allow pots and pans to boil dry, as damage to both pan and hotplate may result.
- Do not use round bottom woks, wok stands or similar curved based pans, as it can lead to overheating of the cooktop causing damage to the appliance, and reflected heat from overhanging woks can cause scorching and possible fire risk for the surrounding bench surface.

- Do not use the cooktop as extra bench space or as a cutting board.
- Do not allow children on or near the cooktop at any time.

Cookware

- You can recognise good cookware from the bottoms of the pans. The bottom should be as thick and flat as possible.

environmental tips

Energy saving

- Always place cookware on the cooking zone before it is switched on.
- Switch cooking zones off before the end of the cooking time, to take advantage of residual heat.
- If possible, always place lids on the pans.

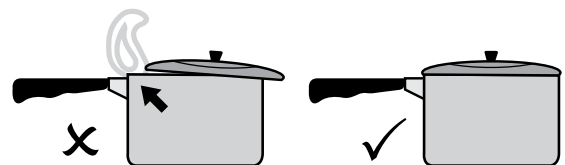

care and cleaning

Before first use

The top surface of the hotplates are sealed with a heat resistant coating. Before using for the first time the hotplates should be heated for a short period without a pan to harden the protective coating.

Turn the heat setting to high for approx 3 minutes to fully harden the coating. When the hotplates have cooled apply a thin coating of cooking oil to the hotplate to seal and protect the surface.

Cleaning your hotplates

Coated 'easy care' solid hotplates have a robust, corrosion resistant surface which is temperature resistant up to 600°C

- Clean the hotplates after they have cooled by wiping with a damp cloth or sponge, use a small amount of detergent if necessary.
- Stubborn soiling can be removed by soaking the hotplate for a few minutes with warm water and a little detergent, followed by cleaning using a plastic scourer or soft brush.
- Any spills or marks that still remain can be burnt off by operating the hotplate on high without a pan for 2–3 minutes. When the hotplate has cooled clean it normally as above.
- After cleaning, dry the hotplate by warming on low heat for approximately 30 seconds and then oil the hotplate with a thin coating of cooking oil to prevent rust or corrosion.
- Some discoloration of the stainless steel trim ring is normal during use. A stainless steel trim ring is normal during use. A stainless steel cleaner may be used to clean the trim ring.

warning

There is a risk of burns if the hotplates are hot. Ensure the hotplates have cooled before cleaning.

caution

Do not allow liquids to enter the control knob area while cleaning.

Stainless steel cleaning

All grades and finishes of stainless steel may stain, discolor or become greasy in normal operation. To achieve maximum surface appearance, stainless steel must be kept clean by regularly using the following cleaning procedures, thus ensuring good performance and long service life.

Wash with warm soapy damp cloth. For an enhanced appearance wipe the surface with a clean damp cloth or sponge, being sure to follow the polish or 'brushing' lines. A stainless steel cleaner may also be used in accordance with the manufacturer's instructions.

Where the stainless steel has become extremely dirty with signs of surface discoloration, (due to periods of neglect or misuse) use a mild cleaning solution stainless steel cleaner. When removing these stains be sure to follow the polish or 'brushing' lines. Do not use abrasive scourers or steel wool.

warning

Watch out! Risk of burns from residual heat.

warning

Sharp objects and abrasive cleaning materials will damage the appliance. Clean with water and washing up liquid.

warning

Sharp cleaning agents will damage the appliance. Remove residues with water and washing up liquid.

Cleaning the appliance after each use

1. Wipe the appliance with a damp cloth and a little washing up liquid.
2. Rub the appliance dry using a clean cloth.

troubleshooting

PROBLEM	POSSIBLE CAUSE	REMEDY
Hotplates not working	Wrong switch turned on	
	Household fuse blown. Note: If the household fuse continues to blow, call the service department	
	Power not connected or switched on	
Low heat, slow cooking	Incorrect cooking utensils being used	Use correct cookware
	Wrong setting on switch	Use correct setting
	Uneven or thin bottoms on pans	Use correct cookware
	Volume of liquid / food is too large	Use less volume
Trim ring discolours	Normal	No action required
Cooktop surrounding element gets hot	Normal	No action required

technical data

environmental tips

Disposal

The symbol  on the product or on its packaging indicates that this product may not be treated as household waste. Instead it should be taken to the appropriate collection point for the recycling of electrical and electronic equipment. By ensuring this product is disposed of correctly, you will help prevent potential negative consequences for the environment and human health, which could otherwise be caused by inappropriate waste handling of this product. For more detailed information about recycling of this product, please contact your local council, your household waste disposal service or the shop where you purchased the product.

Packaging material

The packaging materials are friendly to the environment and can be recycled. The plastic components are identified by marking: >PE<, >PS<, etc. Discard the packaging materials as household waste at the waste disposal facilities in your municipality.

installation instructions

warning

This must be read! The laws, ordinances, directives and standards in force in the country of use are to be followed (safety regulations, proper recycling in accordance with the regulations, etc.)

important

Installation may only be carried out by a qualified electrician. The minimum distances to other appliances and units are to be observed.

Anti-shock protection must be provided by the installation, for example drawers may only be installed with a protective floor directly underneath the appliance.

The cut surfaces of the worktop are to be protected against moisture using a suitable sealant. The sealant seals the appliance to the work top with no gap. Do not use silicon sealant between the appliance and the work top. Avoid installing the appliance next to doors and under windows. Otherwise hot cookware may be knocked off the rings when doors and windows are opened.

warning

Risk of injury from electrical current.

- The electrical mains terminal is live.
- Make electrical mains terminal free of voltage.
- Follow connection schematic.
- Observe electrical safety rules.
- Ensure anti-shock protection by installing correctly.
- The appliance must be connected to the electrical supply by a qualified electrician.
- Loose and inappropriate plug and socket connections can make the terminal overheat.
- Have the clamping connections correctly installed by a qualified electrician.
- Use strain relief clamp on cable.

warning

The surface temperature exceeds 95°C. To avoid a hazard, underbench access must be restricted.

Electrical Connection

Before connecting, check that the nominal voltage of the appliance, that is the voltage stated on the rating plate, corresponds to the available supply voltage. Also check the power rating of the appliance and ensure that the wire is suitably sized in accordance with local wiring rules to suit the appliance power rating. The rating plate is located on the lower casing of the hob. Means for disconnection must be incorporated in the fixed wiring in accordance with local wiring rules. The hob is to be connected to the mains using a

device that allows the appliance to be disconnected from the mains at all poles with a contact opening width of at least 3 mm, eg. automatic line protecting cut-out, earth leakage trips or fuse. The electric hobs are supplied without a cable. Use a cable H05WF 3 x 2.5mm² T90°C or higher.

If this appliance's mains cable is damaged, it must be replaced by a special cable (type H05WF Tmax 90°C; or higher). The connection must be carried out as shown in the diagram. The connecting links should be fitted according to the appropriate connection diagram. The earth lead is connected to terminal. The earth lead must be longer than leads carrying electric current. The cable connections must be made in accordance with regulations and the terminal screws tightened securely. Finally, the connecting cable is to be secured with the mains cable cleat and the covering closed by pressing firmly (lock into place). Before switching on for the first time, any protective foil or stickers must be removed from the glass ceramic surface.

warning

Once connected to the mains supply check that all cooking zones are ready for use by briefly switching each on in turn at the maximum setting.

- A duplicate rating label is supplied with this unit. For easy identification of this unit after installation, stick it to a readily available surface adjacent to the cooktop.

Sticking on the seal

- Clean the worktop around the cutout area.
- Stick the single-sided adhesive sealing tape provided on the underside of the hob around the outside edge ensuring that it is not stretched. The two ends of the tape should join in the middle of one side. After trimming the tape (allow it to overlap by 2-3 mm), press the two ends together.

installation instructions

1. **The bench cutout** – should be made as per diagram (Refer Fig 1A).
2. **Adjacent walls** – (for Square & Rectangular cooktops) must be of suitable material to withstand temperatures of 105°C for 150mm high, i.e ceramic tiles.
3. **A rubber seal** – has been provided for only. This is to be applied around the edge of the hob (Fig. 1B). Note: The rubber seal has had talc powder applied to its surface which should be wiped off with a damp cloth after the unit has been installed.
4. **Pull down clamps** – (Square cooktops) are supplied. When the appliances is in position attach the clamps to the underside of the benchtop and lightly tighten (Fig. 1B).
 - Fit the pull-down clamps supplied to ensure that the Cooktop cannot move after installation.
 - Use the 4 clamps and 4 screws supplied in the parts bag. To assemble, attach the 4 clamps to each corner of the Burner box via the screws provided (Fig. 1C). Position the cooktop so it is centred, then swing the Clamps under the benchtop and tighten.
5. **The rectangular bench cutout** – should be made per diagram (Refer to Fig 2A.)
6. **Retaining brackets** – (Refer to Fig 2B)
 - Rectangular cooktops are supplied attached to the sides of the unit. These must be removed to insert the into the bench.
 - When the unit is in place, using the screws provided, fix brackets with flange against underside of the bench through several alternative holes provided in the sides of the burner box.
 - Protrusions of brackets below the unit should be bent under the unit for safety.
7. **Model identification sticker** – For model identification after installation, an additional data plate sticker has been provided. This sticker is to be attached to adjacent cabinetry.

Square cutout

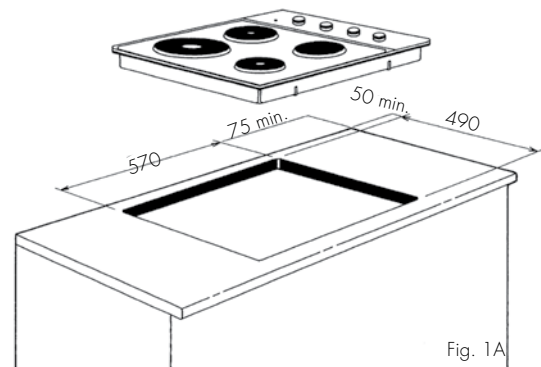

Rubber seal (metal only)

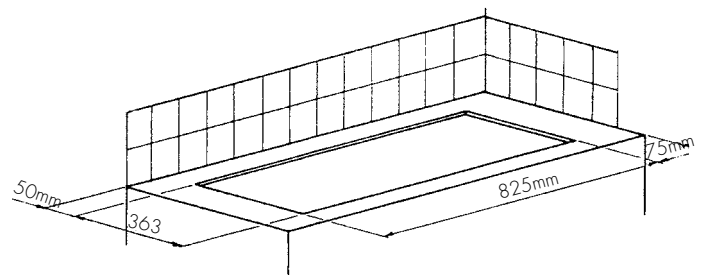
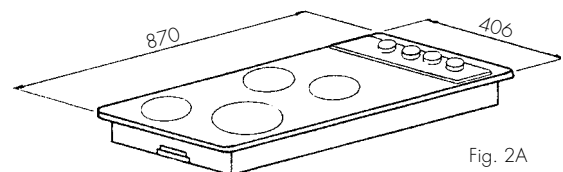
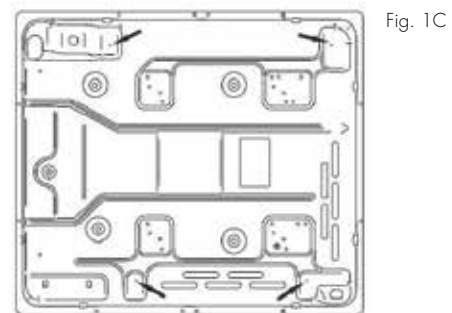
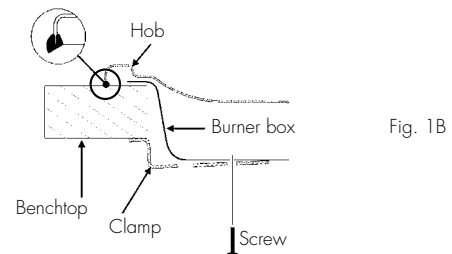

All dimensions are in mm

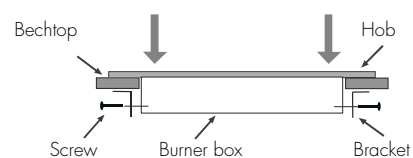



FOR SALES IN AUSTRALIA AND NEW ZEALAND
 APPLIANCE: BUILT-IN OVEN, COOKTOP
 AND FREESTANDING COOKERS

This document sets out the terms and conditions of the product warranties for Electrolux Appliances. It is an important document. Please keep it with your proof of purchase documents in a safe place for future reference should you require service for your Appliance.

1. In this warranty:
 - (a) 'acceptable quality' as referred to in clause 10 of this warranty has the same meaning referred to in the ACL;
 - (b) 'ACL' means Schedule 2 to the Competition and Consumer Act 2010;
 - (c) 'Appliance' means any Electrolux product purchased by you and accompanied by this document;
 - (d) 'ASC' means Electrolux authorised service centres;
 - (e) 'Electrolux' means Electrolux Home Products Pty Ltd of 163 O'Riordan Street, Mascot NSW 2020, ABN 51 004 762 341 in respect of Appliances purchased in Australia and Electrolux (NZ) Limited (collectively 'Electrolux') of 3-5 Niall Burgess Road, Mount Wellington, in respect of Appliances purchased in New Zealand;
 - (f) 'major failure' as referred to in clause 10 of this warranty has the same meaning referred to in the ACL and includes a situation when an Appliance cannot be repaired or it is uneconomic for Electrolux, at its discretion, to repair an Appliance during the Warranty Period;
 - (g) 'Warranty Period' means the Appliance is warranted against manufacturing defects in Australia for 24 months and in New Zealand for 24 months, following the date of original purchase of the Appliance;
 - (h) 'you' means the purchaser of the Appliance not having purchased the Appliance for re-sale, and 'your' has a corresponding meaning.
2. This warranty only applies to Appliances purchased and used in Australia or New Zealand and used in normal domestic applications and is in addition to (and does not exclude, restrict, or modify in any way) any non-excludable statutory warranties in Australia or New Zealand.
3. During the Warranty Period Electrolux or its ASC will, at no extra charge if your Appliance is readily accessible for service, without special equipment and subject to these terms and conditions, repair or replace any parts which it considers to be defective. Electrolux or its ASC may use remanufactured parts to repair your Appliance. You agree that any replaced Appliances or parts become the property of Electrolux. This warranty does not apply to light globes, batteries, filters or similar perishable parts.
4. Parts and Appliances not supplied by Electrolux are not covered by this warranty.
5. To the extent permitted by law, you will bear the cost of transportation, travel and delivery of the Appliance to and from Electrolux or its ASC. If you reside outside of the service area, you will bear the cost of:
 - (a) travel of an authorised representative;
 - (b) transportation and delivery of the Appliance to and from Electrolux or its ASC.

In all instances, unless the Appliance is transported by Electrolux or an Electrolux authorised representative, the Appliance is transported at the owner's cost and risk while in transit to and from Electrolux or its ASC.
6. Proof of purchase is required before you can make a claim under this warranty.

7. You may not make a claim under this warranty unless the defect claimed is due to faulty or defective parts or workmanship. Electrolux is not liable in the following situations (which are not exhaustive):
 - (a) the Appliance is damaged by:
 - (i) accident
 - (ii) misuse or abuse, including failure to properly maintain or service
 - (iii) normal wear and tear
 - (iv) power surges, electrical storm damage or incorrect power supply
 - (v) incomplete or improper installation
 - (vi) incorrect, improper or inappropriate operation
 - (vii) insect or vermin infestation
 - (viii) failure to comply with any additional instructions supplied with the Appliance;
 - (b) the Appliance is modified without authority from Electrolux in writing;
 - (c) the Appliance's serial number or warranty seal has been removed or defaced;
 - (d) the Appliance was serviced or repaired by anyone other than Electrolux, an authorised repairer or ASC.
8. This warranty, the contract to which it relates and the relationship between you and Electrolux are governed by the law applicable where the Appliance was purchased. Where the Appliance was purchased in New Zealand for commercial purposes the Consumer Guarantee Act does not apply.
9. To the extent permitted by law and subject to your non-excludable statutory rights and warranties, Electrolux excludes all warranties and liabilities (other than as contained in this document) including liability for any loss or damage whether direct or indirect arising from your purchase, use or non use of the Appliance.
10. For Appliances and services provided by Electrolux in Australia, the Appliances come with a guarantee by Electrolux that cannot be excluded under the ACL. You are entitled to a replacement or refund for a major failure and for compensation for any other reasonably foreseeable loss or damage. You are also entitled to have the Appliance repaired or replaced if the Appliance fails to be of acceptable quality and the failure does not amount to a major failure. The benefits to you given by this warranty are in addition to your other rights and remedies under a law in relation to the Appliances or services to which the warranty relates.
11. At all times during the Warranty Period, Electrolux shall, at its discretion, determine whether repair, replacement or refund will apply if an Appliance has a valid warranty claim applicable to it.
12. For Appliances and services provided by Electrolux in New Zealand, the Appliances come with a guarantee by Electrolux pursuant to the provisions of the Consumer Guarantees Act, the Sale of Goods Act and the Fair Trading Act.
13. To enquire about claiming under this warranty, please follow these steps:
 - (a) carefully check the operating instructions, user manual and the terms of this warranty;
 - (b) have the model and serial number of the Appliance available;
 - (c) have the proof of purchase (e.g. an invoice) available;
 - (d) telephone the numbers shown below.
14. You accept that if you make a warranty claim, Electrolux and its ASC may exchange information in relation to you to enable Electrolux to meet its obligations under this warranty.

Important Notice

Before calling for service, please ensure that the steps listed in clause 13 above have been followed.

<p>FOR SERVICE or to find the address of your nearest state service centre in Australia PLEASE CALL 13 13 49 <small>For the cost of a local call (Australia only)</small></p>	<p>SERVICE AUSTRALIA ELECTROLUX HOME PRODUCTS electrolux.com.au</p>	<p>FOR SPARE PARTS or to find the address of your nearest state spare parts centre in Australia PLEASE CALL 13 13 50 <small>For the cost of a local call (Australia only)</small></p>
<p>FOR SERVICE or to find the address of your nearest authorised service centre in New Zealand FREE CALL 0800 10 66 10 <small>(New Zealand only)</small></p>	<p>SERVICE NEW ZEALAND ELECTROLUX (NZ) Limited electrolux.co.nz</p>	<p>FOR SPARE PARTS or to find the address of your nearest state spare parts centre in New Zealand FREE CALL 0800 10 66 20 <small>(New Zealand only)</small></p>

like to know more?

For further information on all appliances, or to obtain detailed dimension and installation information, call into your Retailer, phone or email our Customer Care team or visit our website:

Australia

phone: 1300 363 640
fax: 1800 350 067
email: customercare@electrolux.com.au
website chef.com.au (Chef models)
..... westinghouse.com.au (Westinghouse models)

New Zealand

phone: 0800 234 234
fax: 0800 363 600
email: customercare@electrolux.co.nz
website simpson.co.nz (Simpson models)
..... westinghouse.co.nz (Westinghouse models)

Top service

Top Service encompasses the after sales service provided by The Electrolux Group to consumers including delivery, home service and spare parts.

Chef. We are part of the Electrolux Family.
To add a touch of professional inspiration to your home,
visit electrolux.com.au