



*Make your imagination fly*



© Changhong Electric (Australia) P/L all rights reserved.

## OPERATION MANUAL

Model: LHGP1

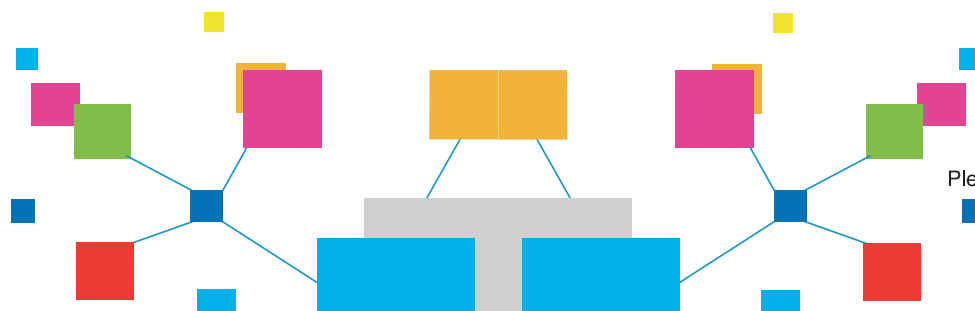

Please read this manual carefully before operating your TV.

# Warnings

## DEAR CUSTOMER:

Before operating, please read all these safety and operating instructions completely and then retain this manual for future reference.

Always comply with the following precautions to avoid dangerous situations and ensure peak performance of your product.



### WARNING:

TO REDUCE THE RISK OF ELECTRIC SHOCK DO NOT REMOVE COVER (OR BACK). NO USER SERVICEABLE PARTS INSIDE. REFER TO QUALIFIED SERVICE PERSONNEL.



The lightning flash with arrowhead symbol, within an equilateral triangle is intended to alert the user to the presence of uninsulated "dangerous voltage" within the products enclosure that may be of sufficient magnitude to constitute a risk of electric shock.



The exclamation point within an equilateral triangle is intended to alert the user to the presence of important operating and maintenance (servicing) instructions in the literature accompanying the appliance.

## REGULATORY INFORMATION

This equipment generates uses and can radiate radio frequency energy and, if not installed and used in accordance with the instructions, may cause harmful interference to radio communication. However, there is no guarantee that interference will not occur in a particular installation. If this equipment does cause harmful interference to radio or television reception, which can be determined by turning the equipment off and on, the user is encouraged to try to correct the interference by one or more of the following measures:

- a. Relocate the receiving antenna.
- b. Increase the separation between the equipment and receiver.
- c. Connect the equipment into an outlet on a circuit different from that to which the receiver is connected.
- d. Consult the dealer or experienced radio/TV technician for help.

### CAUTION

※ Do not attempt to modify this product in any way without written authorization from supplier. Unauthorized modification could void the user's authority to operate this product.

※ Figures and illustrations in this User Manual are provided for reference only and may differ from actual product appearance. Product design and specifications may be changed without notice.

# Warnings

## IMPORTANT WARNINGS AND CAUTIONS!

Electrical energy can perform many useful functions, but it can also cause personal injuries and property damage if improperly handled. This product has been engineered and manufactured with the highest priority on safety. BUT IMPROPER USE CAN RESULT IN POTENTIAL ELECTRICAL SHOCK OR FIRE HAZARD. In order to prevent potential danger, please observe the following instructions when installing, operating and cleaning the product.

1. **Attachments**---Only use attachments/accessories specified by the manufacturer. Do not use attachments not recommended by the manufacturer. Use of improper attachments can result in accidents.
2. **Water**--- To reduce the risk of fire or electric shock, do not expose this apparatus to rain or moisture. The apparatus shall not be exposed to dripping or splashing and that objects filled with liquids, such as vases, shall not be placed on apparatus.
3. **Fire or explosion**---Do not use or store flammable or combustible materials near the unit. Doing so may result in fire or explosion. Do not place any naked flame sources, such as lit candles, cigarettes or incense sticks on top of the TV set.  
**Warning:** To prevent the spread of fire, keep candles or other open flames away from this product at all times.
4. **Ventilation**---When you install your TV, maintain a distance of at least 4 inches between the TV and other objects (walls, cabinet sides, etc.) to ensure proper ventilation. Failing to maintain proper ventilation may result in a fire or a problem with the product caused by an increase in its internal temperature.
5.  This equipment is a Class II or double insulated electrical appliance. It has been designed in such a way that it does not require a safety connection to electrical earth.
6. **Power source**---This product is intended to be supplied by a listed power supply indicated on the marking label. If you are not sure of the type of power supply to your home, consult your product dealer or local power company.
7. **Overloading**---Do not overload wall outlets, extension cables, or convenience receptacles on other equipment as this can result in a risk of fire or electric shock.
8. **Voltage**---Before installing this TV set, make sure your outlet voltage corresponds to the voltage stated on the appliance rating label.
9. **Power plug** --- Do not defeat the safety purpose of the polarized or grounding-type plug. Most appliances recommend they be placed upon a dedicated circuit; that is, a single outlet circuit which powers only that appliance and has no additional outlets or branch circuits.
10. The MAINS plug of the apparatus is used as the disconnect device, the disconnect device shall remain readily operable.

# Warnings

11. **Wall mounting**---When mounting the product on a wall, be sure to install the product according to the method recommended by the manufacturer. This is a safety feature.
12. **Stand**--- Do not place the product on an unstable trolley, stand, tripod or table. Placing the product on an unstable base can cause the product to fall, resulting in serious personal injuries as well as damage to the product.  
Always place the TV on furniture that can safely support the TV. Make sure the ends of the TV do not overhang the edge of the supporting furniture.
13. **Entering of objects and liquids**---Never insert an object into the product through vents or openings. High voltage flows in the product, and inserting an object can cause electric shock and/or short internal parts. For the same reason, do not spill water or liquid on the product.
14. **Damage requiring service**--- This unit should only be serviced by an authorized and properly trained technician. Opening the cover or other attempts by the user to service this unit may result in serious injury or death from electrical shock, and may increase the risk of fire.
15. **Replacement parts**---In case the product needs replacement parts, make sure that the service person uses replacement parts specified by the manufacturer, or those with the same characteristics and performance as the original parts. Use of unauthorized parts can result in fire, electric shock and/or other danger.
16. **Safety checks**---Upon completion of service or repair work, request the service technician to perform safety checks to ensure that the product is in proper operating condition.
17. **Children** ---Do not allow young children to play with the plastic bag that came with the television when you unpacked it. Failure to do so can result in suffocation, causing injury.
18. **Batteries**---The batteries (battery pack or batteries installed) shall not be exposed to excessive heat such as sunshine, fire or the like.
19. **Antenna** ---Install the antenna away from high-voltage power lines and communication cables and make sure it is installed securely. If the antenna touches a power line, contact with the antenna could result in fire, electric shock or serious injury.
20. **Panel protection**--- The panel used in this product is made of glass. Therefore, it can break when the product is dropped or impacted upon by other objects. Be careful not to be injured by broken glass pieces in case the panel breaks.
21. **Operating Temperature:** 5°C to 35°C    **Operating Humidity:** ≤80%  
**Storage Temperature:** -15°C to 45°C    **Storage Humidity:** ≤90%
22. ※ ~ : It Indicates alternating current.  
    ※ --- : It Indicates direct current.

# Warnings

## IMPORTANT INFORMATION

If a television is not positioned in a sufficiently stable location, it can be potentially hazardous due to falling. Many injuries, particularly to children, can be avoided by taking simple precautions such as:

- a. Using cabinets or stands recommended by the manufacturer of the television.
- b. Only using furniture that can safely support the television.
- c. Ensuring the television is not overhanging the edge of the supporting furniture.
- d. Not placing the television on tall furniture (for example, cupboards or bookcases) without anchoring both the furniture and the television to a suitable support.
- e. Not standing the televisions on cloth or other materials placed between the television and supporting furniture.
- f. Educating children about the dangers of climbing on furniture to reach the television or its controls.
- g. The television must to be positioned in a horizontal, stable, un-slippery plane to avoid sliding.



Manufactured under license from Dolby Laboratories. Dolby, Dolby Audio, and the double-D symbol are trademarks of Dolby Laboratories.

# Safety Instructions

## IMPORTANT SAFETY INSTRUCTIONS

1. Read these instructions.
2. Keep these instructions.
3. Heed all warnings.
4. Follow all instructions.

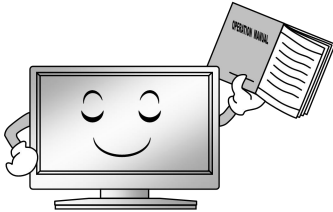

7. Do not block any ventilation openings. Ventilation should not be impeded by covering the ventilation openings with items such as newspapers, table-cloths, curtains etc.



5. Do not use this apparatus near water.



8. Do not install near any heat source such as radiators, heat registers, stoves, or other apparatus (including amplifiers) that produce heat.

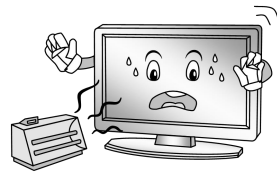

6. Clean only with a dry cloth. Unplug this product from the wall outlet before cleaning. Do not use liquid cleaners or aerosol cleaners.

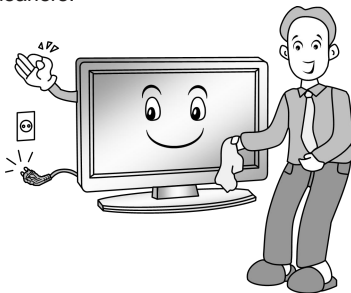

9. Do not defeat the safety purpose of the polarized or grounding type plug. A polarized plug has two blades with one wider than other. A grounding type plug has two blades and a third grounding prong. The wide blade or the third prong is provided for your safety. When the provided plug does not fit into your outlet, consult an electrician for replacement of the obsolete outlet.

# Safety Instructions

10. Protect the power cord from being walked on or pinched particularly at plugs, convenience receptacles, and the point where they exit from the apparatus.



13. For added protection for this product during a lightning storm, or when it is left unattended and unused for long periods of time, unplug it from the wall outlet and disconnect the cable system.



11. Educate children about the dangers of climbing on furniture to reach TV controls.

12. When a cart is used, use caution when moving the cart/apparatus combination to avoid injury from tip-over. Sudden stops, excessive force and uneven floor surfaces can cause the product to fall from the trolley.



14. Refer all servicing to qualified service personnel. Servicing is required when the apparatus has been damaged in any way, such as power supply cord or plug is damaged, liquid has been spilled or objects have fallen into the apparatus, the apparatus has been exposed to rain or moisture, does not operate normally, or has been dropped.



## NOTE:

- ※ Disposal of this product must be carried out in accordance to the regulations of your local authority. Do not dispose of this product with general household waste disposal.
- ※ Occasionally, a few non-active pixels may appear on the screen as a fixed point of blue, green or red. Please note that this does not affect the performance of your product.
- ※ Avoid touching the screen or holding your finger(s) against it for long periods of time. Doing so may produce some temporary distortion effect on the screen.
- ※ It is not recommended to keep a certain still image displayed on the screen for a long time as well as displaying extremely bright images on screen, reduce the 'brightness' and 'contrast' when displaying still images.

# Main Unit Controls

## Front Panel

---

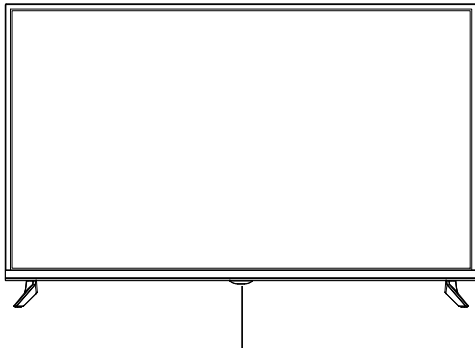

Remote sensor  
Power Indicator

POWER/MENU Button :



- Long Press for power off.
- Short Press for power on / quick menu.
- short press to select options ,or switch the items.  
Long press to confirm and enter into the items.

Press the  button to open the quick operation menu:



 : Turn off the TV.

P+/P- : Changes the channels.

 /  : Adjust the volume level.

 : Switch the input source items.

### NOTE:

- ◆ Keypad may change model to model.



# Main Unit Controls

## Back view controls and sockets

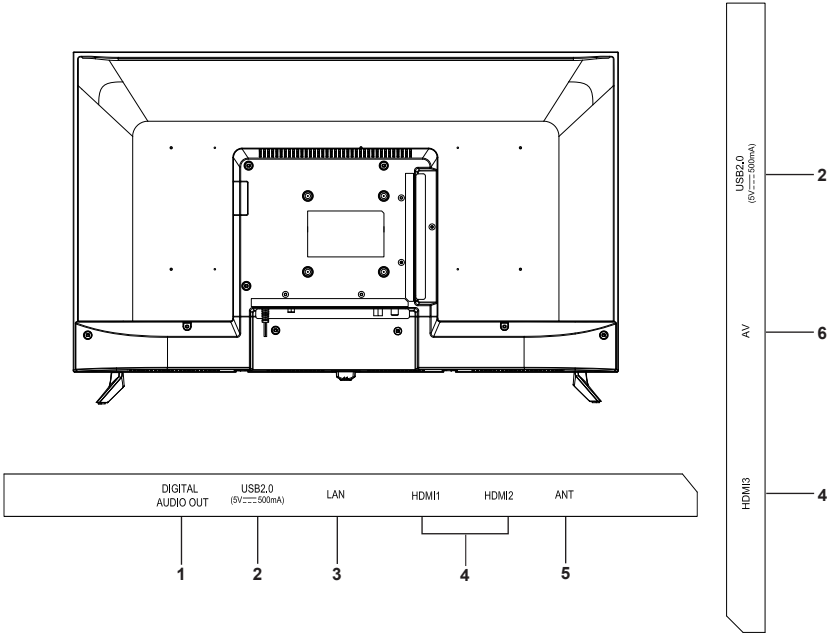

No.	Name	Description
1	DIGITAL AUDIO OUT	Coaxial digital audio input socket.
2	USB2.0	USB port. Connector a USB Storage device for multimedia file playback.
3	LAN	Local area network (LAN) port. Connect a LAN cable to this port to connect to the Network.
4	HDMI	HDMI (High-Definition Multimedia Interface) input.
5	ANT	Connection of the external antenna.
6	AV IN	AV audio/video signal input.

**NOTE:** Input / Output connectivity options may change from model to model.

# Getting Started

## Cable Installation

---

Before the installation and use, please read carefully the relevant content in “Warning and Safety instructions”.

Take out the TV from the wrapping package and put it in a drafty and flat place.

### NOTE:

- ◆ When you plug or unplug the power cable, you must make sure that the TV, computer or other equipment have been already shut down.
- ◆ When unplugging the power cable or signal cable, please hold the plug (the insulated part); do not draw the body of the cable.
- **LAN:** Use a network cable to connect the interface and the broadband network interface.
- **HDMI:** (High-Definition Multimedia Interface) it provides an uncompressed digital connection that carries both video and audio data by way of an integrated mini-plug cable.

### NOTE:

- ◆ While connecting the HDMI, please aim at carefully, do not insert overexerted, for fear the pin might be broken.
- **ANT:** Connect the antenna to TV via coaxial cable on ANT jack of the back panel.
- **DIGITAL AUDIO OUT:** Send the TV's audio signal to external audio equipment via the Digital Audio Output port.
- **USB2.0:** Connect a USB Storage device and multimedia file playback.
- **AV IN:** The output AV terminal of DVD can be connected with the AV input port of the TV through AV cable.

### NOTE:

- ◆ If AV works as mini terminal, please choose to use a one-to-three audio & video cable.

### NOTE:

- ◆ The range of power input for the TV is 100-240V~ 50/60Hz; do not connect the TV power input port with the power cable out of the above range.
- ◆ Please hold the insulated part of the plug when you are unplugging the power cable, do not touch directly the metallic part of the cable.
- ◆ Before connecting to an external device, please firstly make sure that the TV set and the external device have been turned off. When connecting, please make reference to the interface name and the interface color to connect the signal cable.
- ◆ The unit has a built-in wireless network card, and can directly receive network signals from wireless router through WIFI antenna.

# Getting Started

## Using the Remote Control

---

When using the remote control, aim it at remote sensor on the television. If there is an object between the remote control and the remote sensor on the unit, the unit may not operate.

- Point the remote control at the REMOTE SENSOR located on the television.
- When using this television in a very brightly lit area, the infrared REMOTE CONTROL SENSOR may not work properly.
- The recommended effective distance for using the remote control is about 7 metres.

## Installing Batteries in the Remote Control

---

1. Open the cover at the back of the remote control.
2. Install two AAA size batteries. Make sure to match the “+” and “-” ends of the batteries with the diagram inside the compartment.

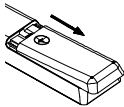

3. Replace the cover.

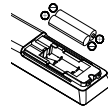
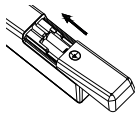

## Battery Replacement

---

You will need to install the batteries into the remote control to make it operate following the instruction below.

When the batteries become weak, the operating distance of the remote control will be greatly reduced and you will need to replace the batteries.

### Notes on Using Batteries:

The use of the wrong type of batteries may cause chemical leakage and/or explosion. Please note the following:

- Always ensure that the batteries are inserted with the + and - terminals in the correct direction as shown in the battery compartment.
- Different types of batteries have different characteristics. Do not mix different types.
- Do not mix old and new batteries. Mixing old and new batteries will shorten battery life and/or cause chemical leakage.
- Replace batteries as soon as they do not work.
- Chemicals which leak from batteries may cause skin irritation. If any chemical matter seeps out of the batteries, wipe it up immediately with a dry cloth.
- The batteries may have a shorter life expectancy due to storage conditions. Remove the batteries whenever you anticipate that the remote control will not be used for an extended period.
- The batteries (battery pack or batteries installed) shall not be exposed to excessive heat such as sunshine, fire or the like.

### CAUTION:

- It may result in an explosion if batteries are replaced incorrectly.
- Only replace batteries with the same or equivalent type.

# Remote Control

The buttons of the original remote control are as following:

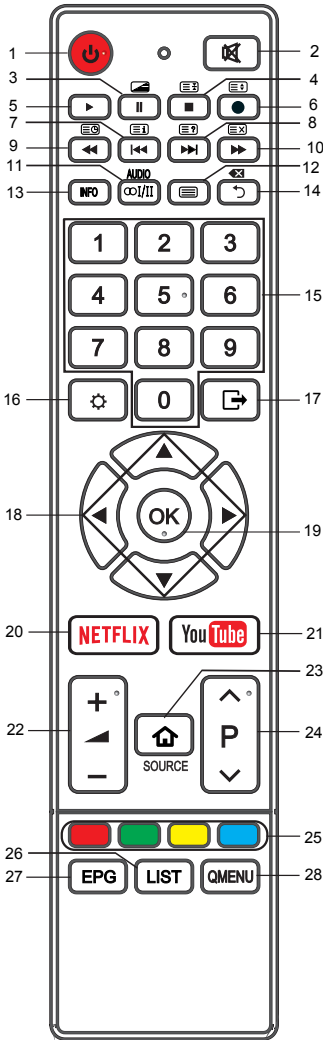

1. **⏻**: Power, Press to enter or exit the standby mode.
2. **🔇**: Press to mute or restore sound.
3. **⏸**: Pause (in Media/PVR mode). Press to start time shift function (in DTV mode). **📺**: Press to enter the MIX mode in the teletext.
4. **■**: Stop the playback (in Media /PVR mode). **📺**: Hold the teletext page on display, press again to release.
5. **▶**: Start playback (in media mode).
6. **●**: Press ● button to start recording (In DTV mode). **📺**: Change size of teletext screen in display mode.
7. **⏮**: Skip to the beginning of the previous. (in media mode). **📺**: Go to the index page.
8. **⏭**: Skip to the beginning of the next. (in media mode). **📺**: Reveal the hidden information of some teletext pages.
9. **⏪**: Reverse playback rapidly. (in media mode). **📺**: Enter subtitle mode or subpage.
10. **⏩**: Advance playback rapidly. (in media mode). **📺**: Cancel the teletext but not to exit teletext.
11. **AUDIO(∞/I/II)**: Press to select the NICAM modes in Analog TV mode. Press to select desired audio language in Digital TV Mode.
12. **📺**: Enter the Teletext, and press this button again to exit.
13. **INFO**: display the current program information on the screen.
14. **↶**: Return to the previous menu. **✖**: Delete button.
15. **NUMBER BUTTONS**: Choose channels or password importation.

# Remote Control

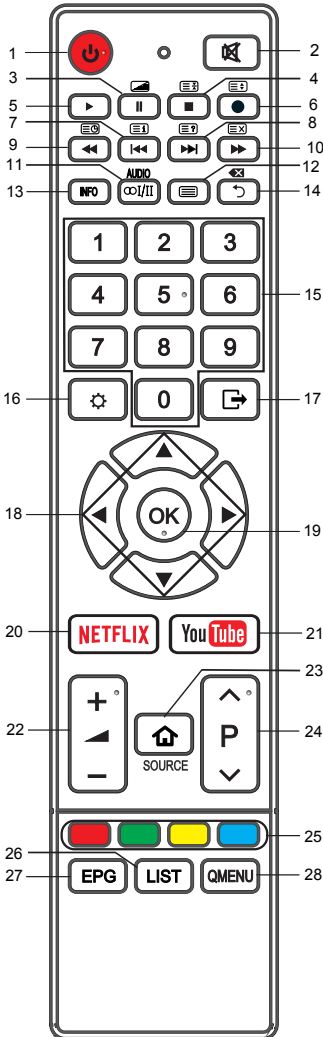

16. **MENU** (⚙️): Press to enter the menu screen for various optional adjustable settings.
17. **EXIT** (⏏️): Quit the current interface.
18. **▲/▼/◀️/▶️**: Press the direction buttons to select menu options or settings.
19. **OK**: Select the current item or enter into the function of the menu of the next level.
20. **NETFLIX**: Goes to NETFLIX homepage.
21. **You Tube**: Goes to YouTube homepage.
22. **+ ▲ -**: Press to adjust the volume level up or down.
23. **SOURCE** (🏠): Select signal source, and accesses the main scene interface.
24. **^ P v**: Press to select channels in ascending or descending order.
25. **COLOR BUTTONS**: Red/ green/ yellow/ blue key navigation link. Use in accordance with the operation interface instructions. Green button is linked to Freeview Plus in certain conditins.
26. **LIST**: Press to call up the channel list. Press again to exit it.
27. **EPG**: Electronic Program Guide, use in the DTV mode.
28. **QMENU**: Press to enter quick menu.

## NOTE:

- ◆ The colour and shape may vary depending on the model.
- ◆ The buttons not mentioned here are not used.
- ◆ All pictures in this manual are examples, only for reference, actual product may differ from the pictures.

# Basic Operation

## Freeview Plus

---

This television is proudly Freeview Plus\* certified – Freeview Plus provides access to content and services from the Freeview networks. The Freeview Plus service provides a 7+ day Electronic Program Guide, all available Catch Up TV\*\*, recommendations and the ability to set reminders and favourites.

### How to access to Freeview Plus?

First ensure that the TV is connected to the internet and an antenna system. Then when you're watching TV, you'll see a prompt at the top left of the screen. Press the 'Green' button on your remote to launch Freeview Plus. More information about Freeview Plus can be found on [www.freeview.com.au](http://www.freeview.com.au) .

\*Freeview Plus uses HbbTV technology which combines broadcast and broadband. Internet connection is required. Data usage charges and conditions apply.

\*\*Freeview Plus is available throughout Australia but Catch Up services vary by region – please check [www.freeview.com.au](http://www.freeview.com.au) to see what's available in your area.

### What is Freeview Plus?

#### ■ Catch up

Now you can access all of the available Catch Up TV programs in one place on your TV. Go backwards in the program guide to find available Catch Up programs or go straight to the network's Catch Up service.

#### ■ Electronic Program Guide

Find out what's on Freeview over the next 7 days and go backwards to see what's available on Catch Up TV. Freeview Plus lets you keep watching while you browse other channels and shows.

#### ■ Browse & Search

Looking for a specific show or movie? Feel like comedy? BROWSE by genre or SEARCH by the program's title. Freeview Plus makes it easy to find your favourite programs and discover new ones!

#### ■ Keep Favourites

Keep all your favourites listed in one place and access them with a simple press of a button. This way you'll know when your favourite show is on again and when it is about to expire in Catch Up.

#### ■ Set Reminders

If there's a program you don't want to miss, simply SET a reminder. Freeview Plus will let you know when your program is about to start. That way, you won't miss a thing!

#### ■ We Recommend...

Not sure what's on TV? Explore TV is your personalised screen dedicated to help you enjoy TV program discovery by combining programs based on your viewing preferences. These include Live TV, Catch Up, Our Picks, Favourites plus Recommended For You.

# Basic Operation

## Turning on and off the TV

---

- **Turn on the TV**

Plug the power cord into a suitable power point, then press the **POWER** (⏻) button, on the lower side of the back panel (or on the remote control, making sure to aim it at the sensor at the front of the TV);

- **Turn off the TV**

Press the ⏻ button on the remote control to enter standby mode. To power down the TV completely, unplug the power cord from the mains socket. Do not leave your set in standby mode for long periods of time. If you will not use the TV for a long time, it is recommended to unplug the set from the mains and aerial.

## First Time Setup

---

If this is the first time you run the TV, the Initial Setup Menu will appear in the picture, and the items of this menu also exist in other menus, so you are able to change the values after you set them up.

**Tips:** Make sure that the antenna or cable TV system connection is made.

- **Set you desired language**

Press the ▲/▼ buttons to select the Menu Language, and then press the **OK** button. Press the ► button to go to the next step.

- **End-User License Agreement**

Select **Accept** and then press the ► button to accept the EULA and go to the next step.

Select **View additional details** and then press the **OK** button to read a detailed EULA.

Press the ◀ button to go to previous step.

- **Select your country**

Press the ▲/▼ buttons to select the country you are living in, and then press the **OK** button.

Press the ► button to go to the next step. Press the ◀ button to go to previous step.

- **Select your time zone**

Press the ▲/▼ buttons to select a time zone, and then press the **OK** button.

Press the ► button to go to the next step. Press the ◀ button to go to previous step.

- **Select your TV environment**

Press the ▲/▼ buttons to select the Home Mode or Store Mode and then press the **OK** button.

- Home is the recommended setting to produce the best energy efficiency. If you want to set Store Mode, a message appears asking you to confirm your choice.

Press the ► button to go to the next step. Press the ◀ button to go to previous step.

- **Network connection (Wired or WIFI)**

Press the ▲/▼ buttons to select "Wired" or "Wifi", and wired or wireless network is enabled respectively. (For more details on connection, please refer to the "Network settings".)

Select "Skip" and press OK to cancel the network setup and move to next step.

## Basic Operation

- **Select the antenna type**

Press the ▲/▼ buttons to select the tuning modes and then press the **OK** button.  
(For more detailed information, please refer to Channel menu → Auto Tuning).

Press the ► button to go to the next step. Press the ◀ button to go to previous step.

- **The TV starts Auto Tuning.**

### NOTE:

- ◆ If the TV doesn't receive any channels, please check your aerial connection or the country you selected, and then try an auto search again.
- ◆ If the TV just receives some of the channels, it means the aerial's reception isn't good enough and an antenna service is recommended.

### Programme Selection

---

- **Using the ▲/▼ on the panel of TV or ^P▼ on the remote control.**

Press **P ▲** to increase channel number.

Press **P ▼** to decrease channel number.

- **Using 0-9 Digital Buttons.**

You can select the channel number by pressing 0 to 9. Example:

To select - channel (e.g. Channel 5): Press 5.

To select -- channel (e.g. Channel 20): Press 2 and 0 in a short time.

### Volume Adjustment

---

- Press the +/- on the panel of TV or + ▲ - on the remote control to adjust the volume.
- If you want to switch the sound OFF, press the 🔇.
- You can release mute by pressing the 🔊 or increase the volume.

### Changing the Input Source

---

1. You can select the input source by pressing the **SOURCE (🏠)** button on the remote control.
2. Press the arrow button to cycle through the input source, and press the **OK** button to confirm your choice.



# Menu Operation

## How to Navigate Menus

Before using the TV follow the steps below to learn how to navigate the menu in order to select and adjust different functions. The access step may differ depending on the selected menu.

1. Press the **MENU** (⚙️) button to display the main menu.
2. Press the **▲/▼** button to select the desired sub item.
3. Press the **OK** or **▶** button to access the menu of the next level.
4. Press the **BACK** (⏪) button to return to the previous menu.
5. Press the **EXIT** (⏏) button exit from the menu.

### NOTE:

- ◆ When an item in MENU is displayed gray, it means that the item is not available or cannot be adjusted.
- ◆ Buttons on the TV have the same function as corresponding buttons on the remote control. If your remote control is lost or couldn't work, you may use the buttons on the TV to select menus. This manual focuses on operation of the remote control.
- ◆ Some items in the menus may be hidden depending on modes or signal sources used.
- ◆ TV's OSD (On Screen Display) may differ slightly from that shown in this manual.

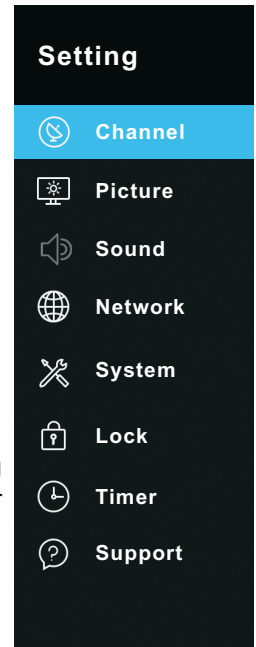

# Menu Operation

## Configuring the Channel Menu

- **Auto tuning:** Press the **OK** button to enter sub-menu.
  - **Tune Type:** Press the **▲/▼** button to select tune type: DTV+ATV, DTV, ATV.
  - **Country:** Press the **▲/▼** button to select country.
  - **Service Type:** Select the service type to search.
  - **LCN:** Select the LCN functions On or Off.
  - **Search:** Press the **OK/▶** button to start the auto searching.

Once the progress bar is full, the found channels will be stored and the unit will proceed to the search for DTV, ATV, Radio and Data.

- If the tune type is DTV+ATV, you can press the **MENU (⚙)** button in TV searching,

the Auto Tuning will skip to ATV searching as the suggestive picture shows.

- **DTV Manual Tuning:** Manual store for digital channels.

1. Press the **◀/▶** button to select channel, Scan Mode and Service Type.

2. Press the Select button to start channel tuning.

When a channel is found, the searching process will stop; the channel will be saved with current channel number. Press the **EXIT (⏏)** button to exit.

- **ATV Manual Tuning:** Manual store for ATV channels.

1. Press the **▲/▼** button to select items.

2. Press the **◀/▶** button to adjust it.

3. When setting is completed, Press the **▼** button to select "SAVE" to save it.

- **Dynamic Rescan:** Switch the Dynamic Rescan function On or Off.

### ■ Channel Edit

Press the **▲/▼** buttons select the Channel Edit, then press the **OK** button to enter sub-menu.

1. Press the **▲/▼** button to select a channel.

2. Press the **◀/▶** button to select the following or preceding page.

3. **Delete:** Press the **RED** button to delete the channel.

**Favourite:** Press the **Green** button to set the favorite channel.

**Move:** Press the **YELLOW** button to set the channel to moving state, and then press the **▲/▼** buttons to move it to the position you want to put.

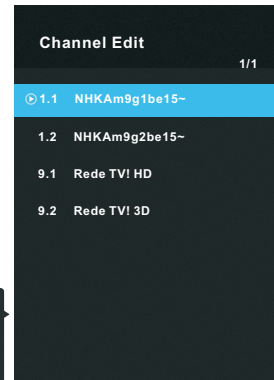
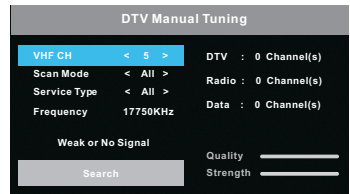
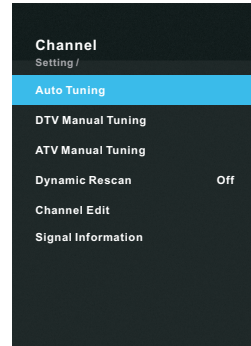

# Menu Operation

**Skip:** Press the **BLUE** button to skip the channel. (Your TV set will skip the channel automatically when using **^Pv** to view the channels.)

- **Signal Information (In DTV mode):** Display the current Signal Information.

## Configuring the Picture Menu

---

- **Picture Mode:** You can select the type of picture which best corresponds to your viewing requirements. Contrast, Brightness, Color, Sharpness, Tint (NTSC) and Backlight can be adjusted when the picture mode is set to User.

- **Contrast:** Adjust the white level of the picture.
- **Brightness:** Adjust darkness of black sections in the picture.
- **Color:** Adjust the color intensity of the picture.
- **Sharpness:** Object edges are enhanced for picture detail.
- **Tint:** Adjust the hue of the picture. (Valid only for NTSC signals).
- **Backlight:** To control the brightness of the screen, adjust the brightness of panel.

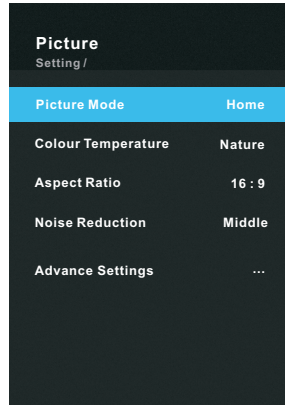

- **Colour Temperature:** Select the color temperature of the picture.
- **Aspect Ratio:** You can select the picture size which best corresponds to your viewing requirements.
- **Noise Reduction:** Reduces screen noise without compromising video quality.
- **Advance Settings:** Use the **▲/▼** button to select Expert Settings, and then press **OK** button to access the submenu page.

**MPEG NR:** Reduces MPEG noise to provide improved picture quality.

**Dynamic Contrast:** Adjusts the contrast to the optimal level according to the image's brightness.

**Film Mode:** Sets the TV so that it senses and then processes film signals from all sources automatically and adjusts the picture for optimum quality.

**PC Mode (In HDMI mode):** When it is set to "On", the TV set is more suitable to be used as a monitor (valid only in the VESA mode of the HDMI channel).

**Overcan (In DTV mode):** The picture reproduction rate is adjusted.

**Picture Reset :** Reset all picture settings to the factory defaults.

# Menu Operation

## Configuring the Sound Menu

- **Sound Mode:** You can select a sound mode to suit your personal preferences. Seven-stage equalization sound can be adjusted when the sound mode is set to User.
  - **Surround Sound:** Press ▲/▼ buttons to select Surround Sound, you can select Off, Low, Middle, and High.
  - **Dialog Enhancer:** Press ▲/▼ buttons to select Dialog Enhancer, you can select Off, Low, Middle, and High. The dialogue enhancer feature allows you to clearly hear the dialogue voice of the TV broadcast, thus avoiding the background sound effects being too loud and the dialogue voice being too small.
  - **AVC (Auto Volume Control):** Press ▲/▼ buttons to select Auto Volume Control, you can select Off, Low, Middle, and High.
  - **Seven-stage equalization setting:** Press the ▲/▼ buttons to select: 120 Hz, 300 Hz, 500 Hz, 1 KHz, 3 KHz, 6 KHz or 12 KHz, and then press the ◀/▶ buttons to adjust the frequency equalization of the sound.
- **Balance:** You can adjust the sound balance of the speakers to preferred levels.
- **SPDIF Mode:** Press ◀/▶ buttons to select SPDIF Type. You can select "PCM" or "Auto". SPDIF (Sony Philips Digital Interface) provides digital audio output to speakers and various digital devices such as A/V Receivers and Home Theaters which reduces interference and distortion.
- **AD Switch (In DTV mode) \*this is only available in some countries, mainly in North America and Europe.** This is an auxiliary audio function that provides an additional audio track for visually challenged persons. This function handles the Audio Stream for the AD (Audio Description), when it is sent along with the Main audio from the broadcaster. Users can turn the Audio Description On or Off and control the volume.
- **AD Volume:** When the AD Switch is set On, the AD Volume can be adjusted.
- **Audio Delay:** Press the ▲/▼ buttons select the Audio Delay, then press the OK button to enter sub menu. You can select "SPDIF Delay" or "Speaker Delay". Correct audio-video sync problems, when watching DTV and when listening to digital audio output using an external device such as an audio receiver (0ms~250ms).
- **Sound Reset :** Reset all sound settings to the factory defaults.

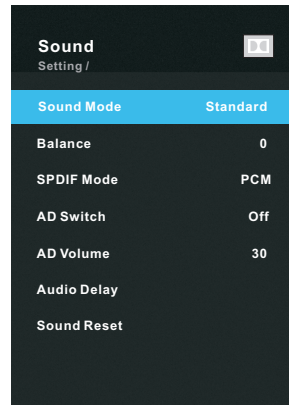

# Menu Operation

## Network Function Operation Instruction

You can set up your TV so that it can access the Internet through your local area network (LAN) using a wired or wireless connection.

### ❑ Connecting to a Wired Network

- You can attach your TV to your LAN using cable in three ways:

You can attach your TV to your LAN by connecting the LAN port on the back of your TV to an external modem using a Cat 5 cable. See the diagram below.

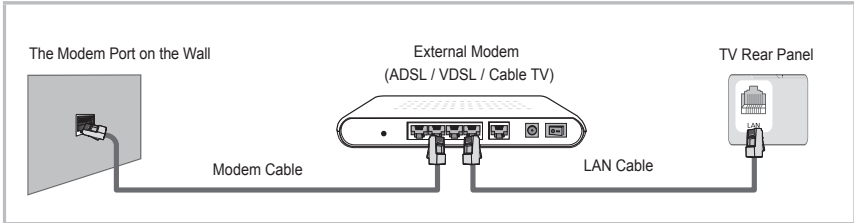

- You can attach your TV to your LAN by connecting the LAN port on the back of your TV to an IP Sharer which is connected to an external modem. Use Cat 5 cable for the connection. See the diagram below.

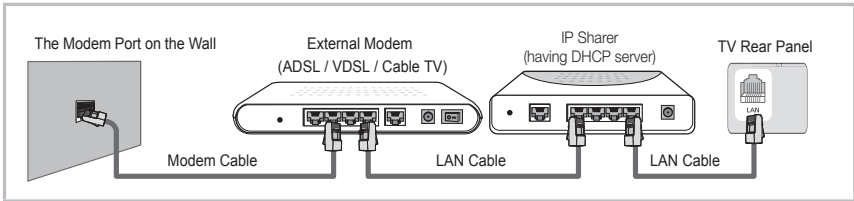

- Depending on how your network is configured, you may be able to attach your TV to your LAN by connecting the LAN by port on the back of your TV directly to a network wall outlet using a Cat 5 cable. See the diagram below. Note that the wall outlet is attached to a modem or router elsewhere in your house.

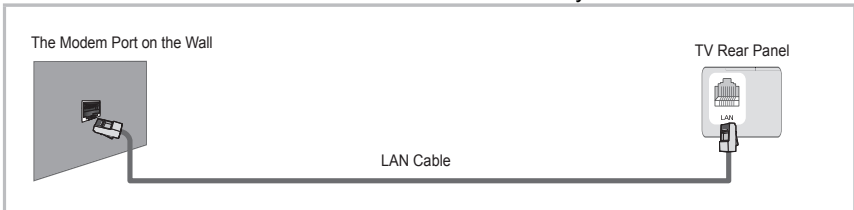

If you have a Dynamic Network, you should use an ADSL modem or router that supports Dynamic Host Configuration Protocol (DHCP). Modems and routers that support DHCP automatically provide the IP address, subnet mask, gateway, and DNS values your TV needs to access the Internet so you don't have to enter them manually. Most home networks are Dynamic Networks. Some networks require a Static IP address. If your network requires a Static IP address, you must enter the IP address, subnet mask, gateway, and DNS values manually on your TV's Cable Setup Screen when you set up the network connection. To get the IP address, subnet mask, gateway and DNS values, contact your Internet Service Provider (ISP). If you have a Windows computer, you can also get these values through your computer.

# Menu Operation

## Wired Network Setup

### – How to set up automatically (Wired)

Use the Automatic Network Setup when connecting your TV to a network that supports DHCP.

1. Connect your TV to your LAN as described in the previous section.
2. Turn on your TV, press the **MENU** (⚙️) button on your remote, use the ▲/▼ buttons to select **Network**.
3. Press the **OK** or ► button to enter. Then press the ▲/▼ button to select **Wired**.
4. Select **IPv4** or **IPv6**. Then press the **OK** button to enter the menu of the next level.
5. Set Network Config. to **DHCP**.
6. Auto acquires and enters the needed Internet values automatically.
7. Select the **Connect** and press **OK** to connect the internet.
8. If the Network Function has not acquired the network connection values, please manually input configuration information.

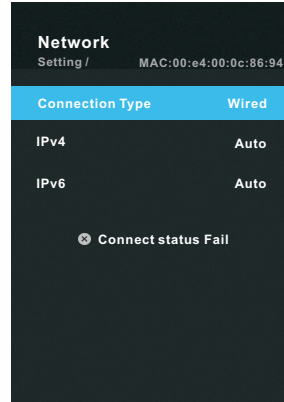

### – How to set up manually (Wired)

Use the Manual Network Setup when connecting your TV to a network that requires a Static IP address.

1. Follow Steps 1 through 4 in the “**How to set up automatically**” procedure.
2. Set Network Config. to **Manual**.
3. Press the ▲/▼ button to highlight the field you want to change, and then use the number buttons to input the network parameters, such as **IP Address**, **Subnet Mask**, **Gateway** and **DNS**. Press **BACK**(↶) key to return.
4. When done, select the **Connect** and press **OK** to connect the internet.

#### **NOTE:**

If you manually set the IP address, you must not use the same IP address for any other device. The IP address you use should be a private address.

#### **Tips for Network Connection:**

- Use a standard LAN cable with this TV. Cat5 or better with a RJ45 connector.
- Many network connection problems during set up can often be fixed by re-setting the router or modem. After connecting the player to the home network, quickly power off and/or disconnect the power cable of the home network router or cable modem. Then power on and/or connect the power cable again.

# Menu Operation

## ❑ Connecting to a Wireless Network

You can connect your TV to your LAN through a standard wireless router or modem.

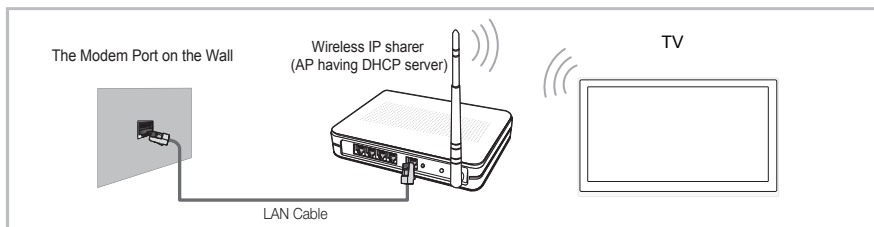

## Wireless Network Configuration

Most wireless network systems incorporate a security system that requires devices that access the network through an access point or wireless router (typically a wireless IP Sharer) to transmit an encrypted security code called an access key.

## Wireless Network Setup

### – How to set up Wifi

1. Turn on your TV, press the **MENU** (⚙️) button on your remote, use the **▲/▼** buttons to select **Network**, and then press the **OK** or **▶** button to enter Connection Type.
2. Press the **▲/▼** button to select **Wifi**. Then press the **OK** button to enter the menu of the next level.
3. The Network function searches for available wireless networks. When done, it displays a list of the available networks. In the list of networks, press the **▲/▼** button to select a network, and then press the **OK** button.
4. On the Please Enter screen, enter your network's Password. To enter the Password, follow these general directions:

Press the **OK** button to display the keyboard at the screen.

Use the direction buttons to select the **⬆️** and press **OK** to cycles through lower case, upper case.

Use the direction buttons to select a letter, special symbols or number, move to the letter, special symbols or number, and then press the **OK** button.

To delete the last letter or number you entered, Use the direction buttons to select **✖** and press **OK**. Press **EXIT** (⏏) to close the keyboard.

5. Input the correct Password and select the **Connect** and press the **OK** button to connect the network.

- **Add:** You can also add a WiFi network manually by selecting Add others. Press **▲/▼** buttons to select Add, then press **OK** button, follow the displayed messages below the menu to input the network name, encryption mode and network password, and then press **▲/▼** buttons to select "**Connect**", the system starts to search wireless routing and connect. When the network is connected, the current wireless network will be added into the list of wireless networks.
- **WOW:** Switch the WOW on or off.

# Menu Operation

## ❑ If Your TV Fails to Connect to the Internet:

- Your TV may not be able to connect to the Internet because your ISP has permanently registered the MAC address (a unique identifying number) of your PC or modem, which it then authenticates each time you connect to the Internet as a way of preventing unauthorized access. As your TV has a different MAC address, your ISP can not authenticate its MAC address, and your TV can not connect.
- To resolve this problem, ask your ISP about the procedures required to connect devices other than a PC (such as your TV) to the Internet.
- If your Internet service provider requires an ID or password to connect to the Internet, your TV may not be able to connect to the Internet.
- The internet connection may fail because of a firewall problem. If this is the case, contact your Internet service provider.

## Configuring the System Menu

---

- **Language:** Select your preferred On Screen Display language.
- **Subtitle:** Switch the Subtitle function on or off.
- **Subtitle Hearing Impaired:** When hearing Impaired is ON, the TV screen will give some information to the people whose hearing are impaired when Hearing Impaired is Off, the information will be hidden.
- **Audio Languages:** Select you're preferred audio language. (Available for digital channels if multiple audio languages are broadcasted.)
- **Subtitle Languages:** Select your preferred subtitle Language. (Available for digital channels if multiple subtitle languages are broadcasted.)
- **HBBTV:** Switch the HBBTV function On or Off.

### NOTE:

- ◆ This service may be supported in other countries.
  - ◆ Some broadcasting may not support the HBBTV.
  - ◆ An application on HBBTV may malfunction temporarily depending on the circumstances of the broadcast station or application provider.
  - ◆ An application is only available for use on HBBTV when the TV network is connected to an external network. The application may malfunction depending on the network conditions.
- **Country:** Display the current country.
  - **HDMI CEC:** Press the **OK / ►** button to enter the submenu. The HDMI CEC system can be used only with devices that have the HDMI CEC feature. You must connect an HDMI CEC device using an HDMI cable. Some HDMI cables may not support HDMI CEC functions.
    - **HDMI CEC:** Switch the HDMI CEC function On or Off.
    - **Auto Standby:** When this set to On, turning off the TV will turn off the connected device as well.
    - **ARC:** Switch the ARC function On or Off.
    - **Auto Power on:** When this set to On, turning on the TV will turn on the connected device as well.

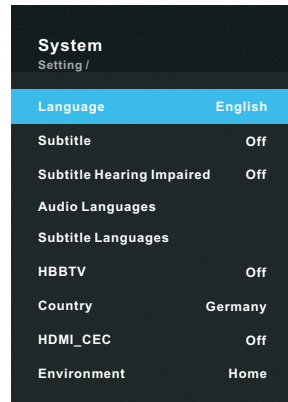

System Setting /	
Language	English
Subtitle	Off
Subtitle Hearing Impaired	Off
Audio Languages	
Subtitle Languages	
HBBTV	Off
Country	Germany
HDMI_CEC	Off
Environment	Home



# Menu Operation

- **Environment:** You can select Home or Store for the TV environment. It is recommended to set the TV to Home Mode.
- **Restore Factory Default:** Restore the system settings to the factory default. When the restore is complete, the TV will enter standby mode.
- **PVR File System (In DTV mode):**

## PVR Function Operation Instruction

### □ Preparing

❶ Plug USB flash drive or USB hard disk into USB slot on the TV set.

#### NOTE:

- USB disk should have capacity at least 512MB.
- USB device must support USB 2.0 high-speed specification.
- Use only USB storage devices formatted with FAT32.

❷ Select a digital channel, the PVR function can only be used in DTV mode;

❸ Then press **MENU** (⚙️) button on the remote to bring the main menu up, press arrows button to highlight **Option** menu, and then press the **OK** button;

❹ Press **▲/▼** buttons to highlight **PVR File System** (In DTV mode), then press **OK** button to go into submenu.

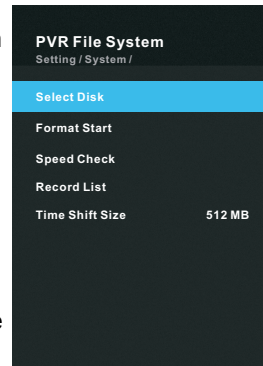

### □ Setting

– **Select Disk:** Select a disk used for PVR.

#### NOTE:

• Some models have two USB input and several disk can be used when two USB devices are plugged in.

– **Format Start:** Format USB disk.

#### NOTE:

• Before formatting, please back up all important files.

• During the device formatting, do not disconnect the device or turn off the power. If your USB device can't be formatted or fail to be checked by the system, it means the device isn't compatible with the TV or is damaged. The larger USB device will take longer time to format please be patient until the formatting finishes.

– **Speed Check:** Press **OK** to check the speed of the storage device.

– **Record List:** Shown the list of recorded programs.

– **Time Shift Size:** You can select the memory size for Time Shift function.

### □ Recording

There are two types of recording: **Instant Recording** and **Schedule Recording**.

## Menu Operation

Instant Recording can record the current TV programmes, while Schedule Recording can start at a specified time and record the TV programmes automatically on the day, time and duration you choose.

### – Instant Recording

- 1 Select the channel you want, then press ● (RECORD) button on the remote control to start recording. A menu will come up on the screen when TV start recording.



- 2 Press ● (RECORD) button to minimize the information bar at the bottom of the screen. Press ● (RECORD) button again to display information about the current recording.

- 3 Press the ■ (STOP) button display a dialogue box: select “Yes” to stop recording, select “No” to dismiss the dialogue box.

**Tips:** You cannot change to a channel from another broadcaster or select another function while in recording mode.

### – Schedule Recording

The unit is able to do schedule recording when TV is turned on or in standby mode.

- 1 Press **EPG** button to bring up Programme Guide menu.

- 2 Then press red button will active timer recording submenu. You can set up time and record mode in the menu.

- 3 Press ▲/▼ button to highlight different setting and press ◀/▶ button to change setting. After you have finished adjusting settings to desired options, press the **OK** button to save the scheduled recording.

#### **NOTE:**

- ◆ You can set up several schedule programmes to record. To do this you will need to press the yellow button in the EPG mode which will show you the entire list. Different schedules should not overlap and there must be at least a 1 minute time gap to set up between two schedules.
- ◆ When recording starts in standby mode, the front indicators will change color and there will be no picture or sound from the unit. You can press ⏻ button to turn on the screen.

### □ Playing the Recorded Programmes

#### **Option1:**

After recording has finished, press the **MENU** (⚙) button on the remote to enter the main menu, press arrows button to highlight **System** menu and press the **OK/▶** button; then press ▲/▼ buttons to select **PVR File System** (In DTV mode), then press the **OK** button to go into submenu.

## Menu Operation

- 1 Press the ▲/▼ buttons to select the Record list.
- 2 Use the ▲/▼ buttons to select a recorded file and press **OK** to start playback in full screen mode.
- 3 Press the **RED** button to delete the file you no longer require.
- 4 Press the **MENU** (⚙) button to return to the previous menu.

### Option2:

Also you can play the recorded programmes in **Media** mode.

- 1 Press **SOURCE** (🏠) button to enter the Smart Home interface.
- 2 Use the ◀/▶ buttons to select **Media**, and then press **OK**.
- 3 Use the arrow buttons and **OK** button to enter the desired disk.
- 4 Use the arrow buttons and **OK** button to open the folder (\_MSTPVR).
- 5 Press the **MENU** (⚙) button to display the setting menu.
- 6 Press the ■ button to stop the playing file.
- 7 Press the **EXIT** (⏏) button to return to the USB main menu.

### ❑ Time Shift Function

This function allows the TV to automatically record live TV and make it available for viewing at any time. With the Time shift turned on, you may rewind normal TV viewing at any time without missing any of the live broadcast.

Press the **II** button on the remote control to activate Time Shift function. The TV stores the channel from the point of view you want to record.



If an USB device dedicated to recording is disconnected, Time Shift files that were saved will automatically be deleted.

### NOTE:

When using the PVR/Media function, remember the following important points:

- ◆ You should use a USB disk with at least 4GB capacity.
- ◆ The connected USB device must support 2.0 speeds.
- ◆ We strongly recommend you back up all data in the USB storage device or another storage device so you do not risk losing any data in case of an unexpected device failure or accident. We do not assume liability for any loss of data due to misuse or malfunction. Data backup is your personal responsibility.
- ◆ You cannot change to a channel from another broadcaster or select another function while in recording mode.
- ◆ If the signal is interrupted or removed while in recording mode, the recording will stop until the signal is established. This may cause you to lose program content.
- ◆ Some USB storage devices may not be compatible for smooth operation with this TV.

# Menu Operation

- ◆ For large file sizes and large capacity storage devices, the loading speed may be longer. The recognition speed of a USB storage device may vary depending on the device.
- ◆ When connecting or disconnecting the USB storage device, ensure the TV is not in USB mode, otherwise the USB device or the files stored in it may be damaged.

## Configuring the Lock Menu

---

- **Lock System:** The feature can prevent unauthorized operating the TV set, unless entering 4-digit password.  
Press **0-0-0-0** using Direct Channel Selection Buttons (0-9). (This is default password.)

**NOTE:**

- ◆ If you forget your password, use the factory password **1-2-2-5**, you can then gain access to change your password if necessary.
- **Set Password:** Press the **OK** button to enter submenu. You can set your private password. Press the number buttons on the remote control to set the new password. When the new password has been input twice, the setting is finished successfully. The TV will go back to previous menu.
- **Block 7\ UbbY (In ATV/DTV mode):** Press **▲/▼** buttons to select which program will be blocked then press **Yellow** to set block. Press the **Yellow** button again to unblock it. (Only available when Lock System set to on)
- **Parent Lock (In DTV mode):** Press the **▲/▼** buttons to select age rating. This feature can prevent children watching adult's TV program, according to the rating limit set.

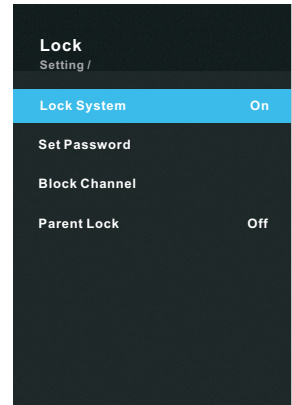

# Menu Operation

## Configuring the Timer Menu

---

- **Auto Sync.:** If set it to ON, the TV will sync the local clock according to the DTV broadcasting time automatically.
- **Time Zone:** Display your time zone
- **Clock:** Display either the DTV signal stream time or set the time manually.
- **Sleep Timer:** Sleep Timer switches the TV to standby after a defined period of time. To cancel the Sleep Timer, set to "Off".
- **Auto Sleep:** Select the Auto Sleep time you want. The TV will enter into standby mode automatically when there is no operation in set time.
- **No Signal Power Off:** When set to "On", if there's no TV signal nor press-button operation, TV will enter standby status automatically about 5 minutes later.

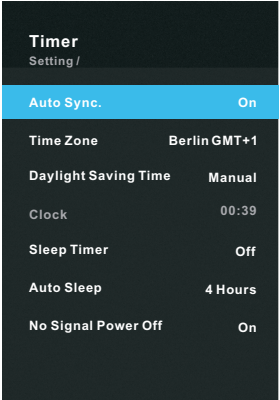

### NOTE:

When the "Auto Sync" is set to "On", Clock option become grey and can't be adjusted.

## Configuring the Support Menu

---

- **USB Upgrade:** Update the software using the USB memory device. Please be careful not to disconnect the power or remove the USB drive until updates are complete.
- **Internet Update Check:** To use network upgrade, you must have configured your TV to connect to your network and the TV must be connected to the Internet.
- **Software Version:** Display current software version information.
- **Installation Guide:** This is an installation guide to help you to setup the TV.
- **View End-User License Agreement:** Read and accept/decline the EULA.
- **App Settings:** Display information about the Netflix.

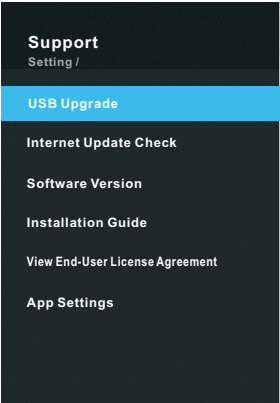

# Menu Operation

## PROGRAMME GUIDE (In DTV mode)

Press **EPG** button to display the Programme Guide menu. This function let you know the detailed information of the channel, indicating the time of the program playing. From the PROGRAMME GUIDE it is possible to check the program information for the next eight days (If the information is available from the broadcaster). Press **EXIT** (⏏) button to exit.

**Channel:** Press the green button to display the Channel list.

**Record:** Press red button to set the parameters for recording. The unit is able to do schedule recording when TV is turning on or in standby mode. You can set up several schedule recording. Different schedules should not overlap. When recording starts in standby mode, the front indicators will change color and there will be no picture or sound from the unit.

**Schedule:** Press the yellow button to display the Schedule list.

**Remind:** If you find the desired program which will be shown in the future. Press the blue button to book program.

Press **^Pv** button to page up or down the list .

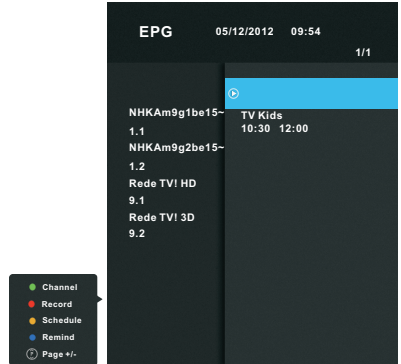

## Channel List

Press **LIST** button to display the Channel List.

Press the **▲/▼** buttons to select the channel and press **OK** to watch it.

Press the **Green** button to enter the favorite list.

Press the **Blue** button to enter Programme Edit.

Press the **Yellow** button to search channel.

Press **◀/▶** button to page up or down the list.

Press **EXIT** (⏏)/**LIST** button to exit.

Press the **MENU** (⊞) key to enter setting menu.

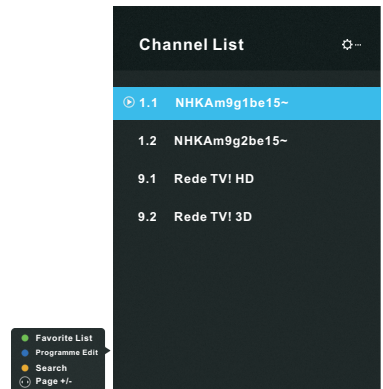

# Menu Operation

## Q.MENU

---

Press **Q.MENU** button on the remote control to display the quick menu.

Press **▲/▼** to select the items, and press the **OK/▶** button; then press **▲/▼** buttons to adjust.

(Options: Picture Mode, Sound Mode, Sleep Timer, Aspect Ratio, Sports Mode, Subtitle Languages, etc...)

Press **Q.MENU** button to exit.



# Home Page

## □ Smart Home Operation Introduction

Home is an entry interface for all the other functions, which could enter from this interface layer by layer.

Via using home menu function, different needs of users could be met, making them fully enjoy video and audio effects brought by the machine.

Press **SOURCE** (🏠) button to open home interface, as shown in the following figure.

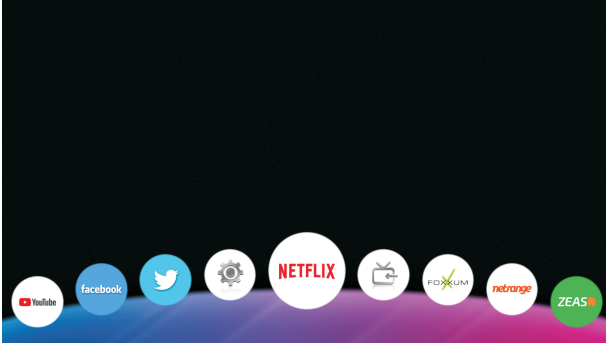

Press arrow buttons to cyclically select all options. Press **OK** button to enter a small window for selection. Press **EXIT** (⏏) button to exit home interface.

## Media Playback

The media function of this unit enables you to read movable USB storage devices such as USB drive, USB mobile hard disk, and USB card reader, and you can also browse files, play pictures, play videos, and play music in the corresponding files in the above devices.

### **NOTE:**

- ◆ Special USB device may be not or well supported.
- ◆ USB max. Load: DC5V 500mA.

### • **The formats supported**

The media function can support the USB device with USB memory.

It can play PHOTO, MUSIC and VIDEO files.

Photo Format Support: JPEG, BMP, PNG ...

Music Format Support: MP3, AAC, M4A...

Video Format Support: AVI, MPEG -1 / MPEG-2 / MPEG-4, TS/TP...

### Enter / exit the media

1. First, insert a USB memory device into the USB port.
2. Press the arrow buttons to select Media, and the press **OK** button to access the Media mode.
3. Press arrow buttons to cyclically select Files, Music, Photo and Video.
4. Press the **EXIT** (⏏) button to exit.



# Home Page

## Main Operating Interface



### ■ Basic operation

1. Press ▲/▼ buttons to cyclically select Files, Music, Photo and Video in the USB main menu.
2. Use the arrow buttons to highlight the folder, and then press the **OK** button.
3. Use the arrow buttons to highlight the Music /Photo/ Video. Press **OK** button to play the selected Music /Photo/Video.
4. Press the **BACK** (↶) button to return to previous menu screen.
5. Press the **EXIT** (⏏) button to return to the USB main menu.

### ■ Play Files

1. When entering the main interface of the media, press the ▲/▼ key to select the file types, and press the down key or the **OK** key to enter the content selection interface of such types of files.
2. When one file is selected, press the **OK** key to play.

### ■ Music Play

When entering “Media”→“Music”, follow the above operation mode to start playing music files.

1. Press the up / down key to select the music in the list repeatedly, and press the up key to enter the music player console, press the down key to close the console.
2. Press the **OK** key to pause or continue to play music.
3. Press the **MENU** (⚙) key to recall “Music setting” menu. Press the **BACK** (↶) key to return to the status before music play.

### ■ Music Play Setting Menu

When the **MENU** (⚙) key is pressed to enter the “Music setting” menu, the remaining operations are similar to those of the video play setting menu.

1. Sound mode: Select the different sound effect.
2. Balance: Adjust the sound balance of the speakers to preferred levels.

# Home Page

## • Music Play Console

Press the up key to enter the music player console, press the up / down key to select the control button repeatedly, and press the **OK** key to perform the functions of the selected key. To close the play console, please press the **BACK** (↶) key.

1. Stop: Stop play the music.
2. Setting: To enter the music play setting menu.
3. Info: Music information.
4. LRC: To switch between the lyrics synchronization and play list.
5. Play Mode: Select the different play mode.
6. Audio only: Turn off the screen only play the sound.

## • Photo Play

When entering “Media”→“Photo”, follow the above operation mode to start playing picture files.

1. Press the left / right key to select the photo in the list repeatedly, and press the up key to enter the photo player console, press the down key to close the console.
2. Press the **MENU** (⚙) key to recall the “Photo setting” menu. Press **BACK** (↶) to exit the current play and return to the status before play.

## • Photo Play Setting Menu

When the **MENU** (⚙) key is pressed to enter the “Photo setting” menu, press the up / down key to select various options repeatedly, press the **OK** key to enter the menu of the next level. Press the **BACK** (↶) key to return to the menu of the previous level, and press the **EXIT** (⏏) key to directly close the play setting menu.

1. Picture Mode: Select the different picture mode.
2. Sound Mode: You can select sound mode to suit your personal preferences.
3. Balance: Adjust the sound balance of the speakers to preferred levels.

## • Photo Play Console

When playing any file and there is no menu display, and then press the up key to enter the player console. Press the up/down key to select the control button repeatedly, and press the **OK** key to perform the functions of the selected key. To close the play console, please press the **BACK** (↶) key.

1. Stop: Stop play the picture.
2. Setting: To enter the picture play setting menu.
3. Info: Picture information.
4. Right rotate: To rotate right for 90 degrees.
5. Back Music: Turn on or off the background music.
6. Play Mode: Select the different play mode.

# Home Page

## ■ Video Files

When entering “Media”→“Video”, follow the above operation modes to start playing video files.

1. During the normal play process, press and hold the left / right key for rewind / fast forward play.
2. Press the up key to recall the video play console.
3. Press the **MENU** (⚙️) key to recall the play setting menu. Press the **BACK** (⏪) key to return to the status before video play.

## ■ Video Play Setting Menu

Press the **MENU** (⚙️) key to enter the play setting menu, press the up / down key to select various options repeatedly, and press the **OK** key to enter the menu of the next level. Press the **BACK** (⏪) key to return to the menu of the previous level, and press the **EXIT** (⏏) key to directly close the play setting menu.

1. Picture Mode: Select the different picture mode.
2. Sound Mode: You can select sound mode to suit your personal preferences.
3. Balance: Adjust the sound balance of the speakers to preferred levels.
4. Subtitle: Press the **OK** key to enter the menu of the next level to select subtitles and adjust subtitle properties;
5. Audio Track: If video files have multiple audio tracks, user could change tracks.
6. Screen : Adjusts the Screen size.

## ■ Video Play Console

When playing any file and there is no menu display, press the **OK** key to display the play console, press the up key to select the control button repeatedly, and press the **OK** key to perform the functions of the selected key. To close the play console, please press the **BACK** (⏪) key.

1. Stop: Stop play the video.
2. Setting: To enter the video play setting menu.
3. Info: Video file information.
4. Prev: To play the previous file in the same directory.
5. Next: To play the next file in the same directory.
6. Play Mode: Select the different play mode.

# Home Page

## Applications

---

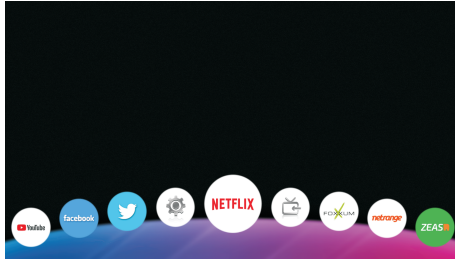

Press **SOURCE** (🏠) button on the remote to display the home main interface. Then use the Arrow buttons to select the desired APP and press **OK** button to view. Or press the hotkey on the remote control to enter the desired APP directly.

### ■ Netflix

Sign in to your Netflix® account to browse by genre, search for titles, manage your Instant Queue and review Netflix® recommendations all from you TV. If you do not have a Netflix® account, you will need to create a new account to use this feature. Watch TV show and movies online or by streaming them from Netflix. For more information, visit [www.Netflix.com](http://www.Netflix.com).

### NOTE:

- ◆ The videos list searched from the TV may different with the list searched from a web browser on PC.
- ◆ The playback videos may be paused, stopped or buffering occurring often depending on your broadband speed. We recommend a minimum connection speed of 1.5 Mbps. For the best playback condition, a connection speed of 4.0 Mbps is required.
- ◆ These services are provided by separate Content Provider. Please visit the content providers web site for specific information on their services.
- ◆ For service that requires log in, join the applicable service on the website using the PC and log in through the TV to enjoy various additional functionalities.

### ■ Multiscreen

- “Multiscreen” it is a mirror technology. You can make Smart TV display same pictures displayed on android device in the same wireless network.
- To start using Multiscreen feature, go to home page and press **OK** on “Multiscreen”.
- Turn on Wireless Display (a.k.a. Wi-Fi Display, Wi-Fi Direct or Cast Screen) function on your smart phone or tablet (Please refer to your device’s user manual for information on how to turn on wireless display).
- Your mobile device will display a list of available devices. Choose ‘TV name’ click on it to connect.
- Your mobile device will connect to the TV and will display the device screen on the TV.



**NOTE:** Your TV and Smartphone must be connected to the same wireless network with this application. Some Android devices may not support this function. (The iOS devices is not supported).

# Teletext

## Using the teletext feature

---

### • Display teletext

1. Select a TV station with a teletext signal.
2. Press the  button to enter teletext mode.
3. Press the  button to enter Mix mode, this function enables you to superimpose the teletext page over the TV program.
4. Press the  button 2nd return or exit to the normal ATV/DTV mode.

### • Page selection

1. Enter the page number (three digits) using the number buttons. If you press a wrong number during input, you must complete the three digit number and then reenter the correct page number.
2. The  button can be used to select the preceding or following page.

### • Hold



You can press the  button to hold a page, and press it again to release the page.

### • Index



Press the  button to enter the main index page directly.

### • Enlarging Text

When a page is displayed, you can double the size of the text to make it easier to read.



1. Press the  button to enlarge the top half of the page.
2. Press the  button again to enlarge the bottom half of the page.
3. Press the  button once more to return to the normal display.

### • Reveal mode

You can display concealed teletext information (e.g. Answer to puzzles or riddles etc.) by pressing  button. Press  button again to remove the information from the display.

### • Subpage

Some teletext may contain several sub-pages which are automatically paged in a certain cycle by the TV station.

1. You can enter into a certain sub page by pressing the  button directly and select the page number with number buttons. Enter the sub page number (e.g. 0003) for the third sub page.
2. Press the button again to exit the sub page mode.
3. Press the  button to return to the normal TV mode.

### • Color buttons (Red, Green, Yellow and blue)

Press these buttons to access directly to the corresponding color pages displayed at the lower part of the teletext screen.

# Troubleshooting Guide

## Troubleshooting

Before contact the service technician, perform the following simple checks. If any program still persists, unplug the TV and calling for serving.

PROBLEM	POSSIBLE SOLUTION
No sound and picture	<ul style="list-style-type: none"> <li>- Check whether the main plug has been connected to a wall let.</li> <li>- Check whether you have pressed the POWER button on the front of TV set.</li> <li>- Check the picture contrast and brightness settings.</li> </ul>
Normal picture but no sound	<ul style="list-style-type: none"> <li>- Check the volume.</li> <li>- Sound muted? Press the MUTE button.</li> <li>- Try another channel, the problem may be with the broadcast.</li> <li>- Are the audio cables installed properly?</li> </ul>
The remote control does not work	<ul style="list-style-type: none"> <li>- Check to see if there any object between the product and remote control Causing obstruction.</li> <li>- Are batteries installed with correct polarity (+ to +, - to -)?</li> <li>- Correct remote operating mode set: TV, VCR etc.?</li> <li>- Install new batteries.</li> </ul>
Power is suddenly turned off	<ul style="list-style-type: none"> <li>- Is the sleep timer set?</li> <li>- Check the power control settings. Power interrupted.</li> <li>- No broadcast on station tuned with auto activated.</li> </ul>
Picture appears slowly after switching on	<ul style="list-style-type: none"> <li>- This is normal; the image is muted during the product startup process. Please contact your service center, if the picture has not appeared after five minutes.</li> </ul>
TV freezes and remote function stop working	<ul style="list-style-type: none"> <li>- The internet function might cause TV to freeze or stop responding to remote.</li> <li>- Unplug your TV from power for at least 1 minute.</li> <li>- Plug power back in and turn it on by pressing power button.</li> <li>- Please contact your service center if it still doesn't work.</li> </ul>
Poor reception , crackling sound or pixelating on screen	<ul style="list-style-type: none"> <li>- Make sure the antenna cable is plugged in properly.</li> <li>-Rescan the TV channels</li> <li>-Adjust antenna direction to make signal more stronger</li> <li>- Channel good quality antenna cables or socket</li> </ul>
HDMI has no picture or sound	<p>Make sure TV is in HDMI mode, press menu then select option menu, go to HDMI EDID setting, change it to ENHANCED if it connect to a 4K device. Otherwise ENHANCED if it connect to a 4K device. Otherwise</p>

# Troubleshooting Guide

## Maintenance

---

Early malfunctions can be prevented. Careful and regular cleaning can extend the amount of time you will have your new TV. Be sure to turn the power off and unplug the power cord before you begin any cleaning.

### Cleaning the screen

1. Here's a great way to keep the dust off your screen for a while. Wet a soft cloth in a mixture of lukewarm water and a little fabric softener or dish washing detergent. Wring the cloth until it's almost dry, and then used it to wipe the screen.
2. Make sure the excess water is off the screen, and then let it air-dry before you turn on your TV.

### Cleaning the cabinet

To remove dirt or dust, wipe the cabinet with a soft, dry, lint-free cloth. Please be sure not to use a wet cloth.

### Extended Absence



If you expect to leave your TV dormant for a long time (such as a vacation), it's a good idea to unplug the power cord to protect against possible damage from lightning or power surges.

### Disposal of old electrical appliances



The European directive 2012/19/EU on Waste Electrical and Electronic Equipment (WEEE), requires that old household electrical appliances must not be disposed of in the normal unsorted municipal waste stream. Old appliances must be collected separately in order to optimize the recovery and recycling of the materials they contain, and reduce the impact on human health and the environment.

The crossed out "wheeled bin" symbol on the product reminds you of your obligation, that when you dispose of the appliance, it must be separately collected.

Consumers should contact their local authority or retailer for information concerning the correct disposal of their old appliance.