

ETE4607, ETE5407,  
EBE4507, EBE5307,  
EBE5367, EHE5267,  
EFE4227, ERE5047

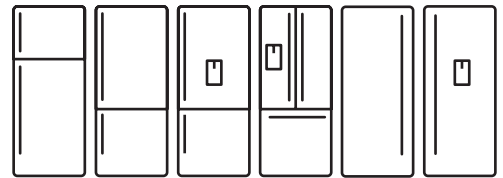

Refrigeration

User manual

## REGISTER YOUR FRIDGE WITH YOUR SMARTPHONE

- 1 Locate the label on the inside of your fridge

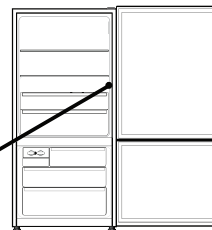
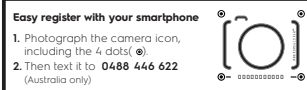

- 2 Photograph the camera icon, including the 4 dots (⦿)
- 3 Text image to 0488 446 622 (Australia only)



© 2017 Electrolux Home Products Pty Ltd. EST\_PhotoRegister\_Fridge\_70x70\_Dec17



**Electrolux**

## CONGRATULATIONS

Dear customer,

Congratulations and thank you for choosing our refrigerator. We are sure you will find your new refrigerator a pleasure to use. Before you use the refrigerator we recommend that you read through the relevant sections of this manual, which provides a description of your refrigerator and its functions.

To avoid the risks that are always present when you use an electric appliance, it is important that the refrigerator is installed correctly and that you read the safety instructions carefully to avoid misuse and hazards.

We recommend that you keep this instruction booklet for future reference and pass it on to any future owners.

After unpacking the refrigerator, please check it is not damaged. If in doubt, do not use the refrigerator but contact your local customer care centre.

The symbols you will see in this booklet have these meanings:



### WARNING

This symbol indicates information concerning your personal safety.



### CAUTION

This symbol indicates information on how to avoid damaging the refrigerator.



### IMPORTANT

This symbol indicates tips and information about use of the refrigerator.



### ENVIRONMENT

This symbol indicates tips and information about economical and ecological use of the refrigerator.

## CONDITIONS OF USE

This refrigerator is designed and intended to be used in normal domestic applications only.

Record model and serial number here:

Model number: .....

Serial number: .....

## CONTENTS

Important safety instructions .....	3
Refrigerator features .....	4
Top mount refrigerator features .....	4
Bottom mount refrigerator features .....	5
Ice & Water .....	6
French door ice & water features .....	7
French door features .....	7
Single door features .....	8
Single door features .....	9
Installing your new refrigerator .....	10
Unpacking your refrigerator .....	10
Locating your refrigerator .....	10
Installing your refrigerator.....	10
Fitting the handles .....	11
Ice & Water models .....	11
Installation .....	12
Changing the water filter .....	14
Using your refrigerator .....	15
Removing Features .....	15
AHC (Auto humidity control.....	15
Freezer Shelves .....	15
Drawers with telescopic slides .....	15
Twist & Serve ice .....	16
LED Lighting .....	16
Controlling .....	17
About the User Interface .....	17
Functions of the user interface .....	18
The freezer user interface .....	20
Error Codes .....	21
General information .....	22
Cleaning the refrigerator .....	22
Food storage guide .....	23
Troubleshooting.....	24
Ice maker troubleshooting .....	26
Noises .....	27
Warranty Information .....	31

## IMPORTANT SAFETY INSTRUCTIONS

*NOTE: You must read these warnings carefully before installing or using the refrigerator. If you need assistance, contact your customer care centre. The manufacturer will not accept liability, should these instructions or any other safety instructions incorporated in this book be ignored.*



### WARNING

- This appliance is not intended for use by persons (including children) with reduced physical, sensory or mental capabilities, or lack of experience and knowledge, unless they have been given supervision or instruction concerning use of the appliance by a person responsible for their safety. Children should be supervised to ensure that they do not play with the appliance.
- It is essential the power point is properly earthed to ground. Consult a qualified electrician if you are unsure.
- Do not use electrical appliances inside the food storage compartments of the appliance, unless they are of the type recommended by the manufacturer.
- Unplug the refrigerator before cleaning or moving it to avoid electric shock.
- Never unplug the refrigerator by pulling the electrical cord as this may damage it. Grip the plug firmly and pull straight out.
- If the power cord is damaged, it must be replaced by the manufacturer, its service agent or similarly qualified persons in order to avoid a hazard.
- Don't use a steam cleaner. If live components come into contact with condensing steam, they may short-circuit or cause an electric shock.
- Do not store explosive substances such as aerosol cans with a flammable propellant in this appliance. If pressurised aerosol containers bear the word 'flammable' and/or a small flame symbol, do not store them inside any refrigerator or freezer. If you do so you may cause an explosion.
- Do not damage the refrigerant circuit.
- This appliance contains insulation formed with flammable blowing gases. Avoid safety hazards by carefully disposing of this appliance.
- If you wish to discard this refrigerator, please contact your local authorities and ask for the correct method of disposal.
- When you dispose of your old refrigerators and freezers, remove any doors. Children can suffocate if they get trapped inside.
- The plug must be accessible when the appliance is in position.
- Never try to repair the refrigerator yourself, only use a qualified or authorised service person for repairs.



### WARNING

#### R600a refrigerant warning

This appliance contains flammable R600a refrigerant. Avoid safety hazards by carefully installing, handling, servicing and disposing of this appliance.

- Ensure that the tubing of the refrigerant circuit is not damaged during transportation and installation.
- Leaking refrigerant may cause eye injuries or ignite.
- The room for installing appliance must be at least 1m<sup>3</sup> per 8g of refrigerant. The amount of refrigerant in the appliance can be found on the rating plate inside the appliance.
- If you are unsure of the refrigerant check the rating plate inside the refrigerator compartment.
- It is hazardous for anyone other than an Authorised Service Person to service this appliance. In Queensland Australia the Authorisation Service Person MUST hold a Gas Work Authorisation for hydrocarbon refrigerants to carry out servicing or repairs which involve the removal of covers.
- Keep ventilation openings in the appliance enclosure or in the built-in structure, clear of obstruction.
- Do not use mechanical devices or other means to accelerate the defrosting process, other than those recommended by the manufacturer.

#### Important Information that may impact your Manufacturer's Warranty

Adherence to the directions for use in this manual is extremely important for health and safety. Failure to strictly adhere to the requirements in this manual may result in personal injury, property damage and affect your ability to make a claim under the Electrolux manufacturer's warranty provided with your product. Products must be used, installed and operated in accordance with this manual. You may not be able to claim on the Electrolux manufacturer's warranty in the event that your product fault is due to failure to adhere to this manual.

# REFRIGERATOR FEATURES

## TOP MOUNT

**LED light**

**TasteGuard Deodoriser**

**Twist & Serve Ice**

Refer to the section "Using your Refrigerator" for details on removing, relocating and using this feature.

**LED lighting**

Your refrigerator is fitted with LED lighting.

**Glass shelves**

The glass shelves improve visibility.

**Wire shelf**

**TasteGuard Deodoriser**

**MultiZone™ deli drawer**

Use the MultiZone™ deli drawer to store foods like small goods, fresh or cooked meat and cheese, or as an additional crisper. The drawer will prevent strong food odours from impacting the rest of the refrigerator. To remove the deli drawer, pull it forward, then lift it up and pull it further forward.

**Auto humidity control**

**TasteLock™ crisper**

Use the crisper to store vegetables, fruit or small goods.

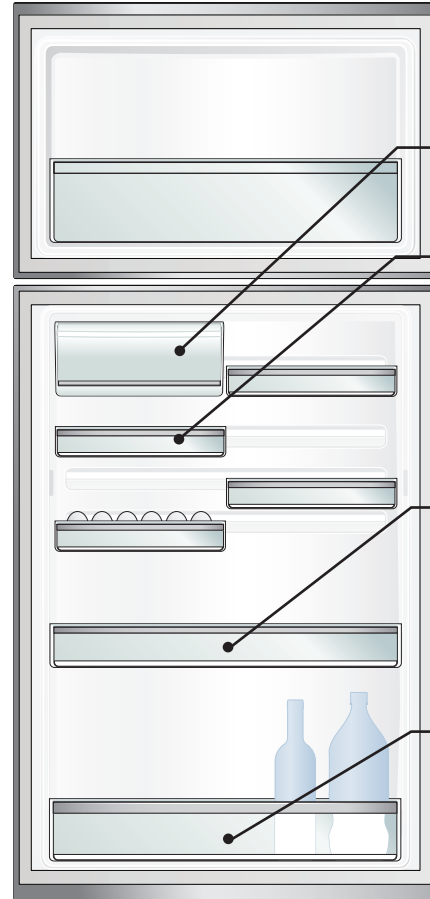
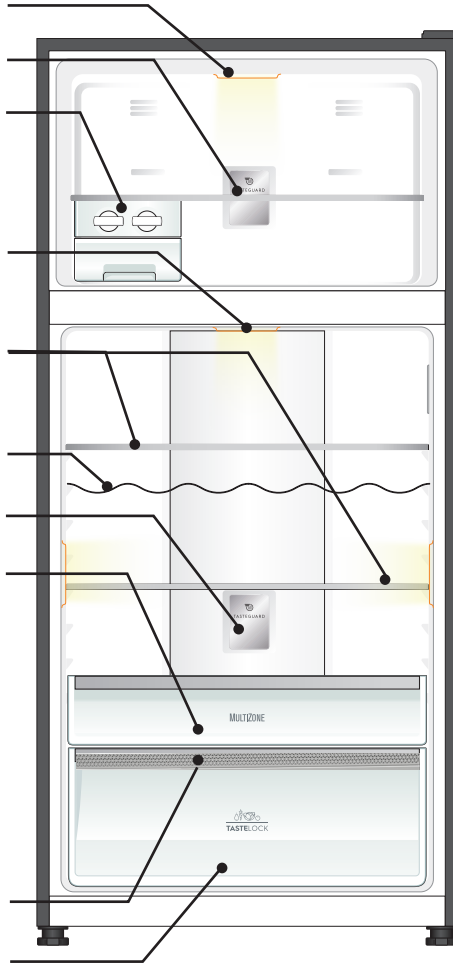

**Dairy compartment**

This compartment can be used to store dairy.

**FlexStor™ door bins**

Slide the bins to meet different storage needs. To remove, lift and tilt. To replace, tilt the top and push down until locked in place.

**Door storage bin**

The door bin can be removed by lifting it up over the support lugs. To replace, push down over the support lugs to lock in place.

**Bottle storage bin**

Use the bottle bin for tall bottle storage. The bottle bin can be removed by lifting it up over the support lugs. To replace, push down over the support lugs to lock in place.

ETE5407 illustrated

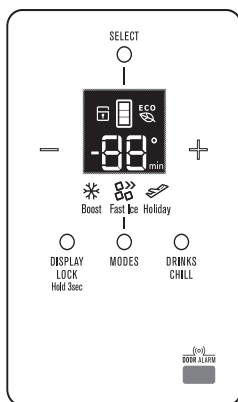

**Refrigerator/freezer control panel**

From this panel you can control the temperature of the refrigerator and freezer compartments as well as setting the Boost function or resetting the door alarm.

For further information on how to use this feature refer to the section "About the User Interface".

Features may vary depending on model. Not all models will have features listed.

## BOTTOM MOUNT

**LED lighting**  
Your refrigerator is fitted with LED lighting.

**Glass shelves**  
The glass shelves improve visibility.

**Wire shelf**

**MultiZone™ deli drawer**  
Use the deli drawer to store foods like small goods, fresh or cooked meat and cheese, or as an additional crisper. The drawer will prevent strong food odours from impacting the rest of the refrigerator. To remove the deli drawer, pull it forward, then lift it up and pull it further forward.

**Auto humidity control**

**TasteLock™ crisper**  
Use the crisper to store vegetables, fruit or small goods.

**Twist & Serve ice**  
Refer to the section "Using your Refrigerator" for details on removing and using this feature.

**Freezer storage bin**  
Refer to the section "Using your Refrigerator" for details on removing, and using this feature.

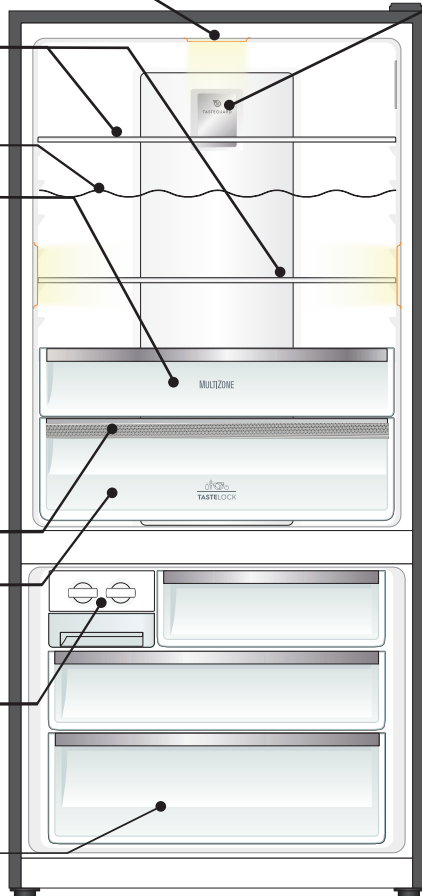

**TasteGuard Deodoriser**

**Dairy compartment**  
This compartment can be used to store dairy.

**FlexStor™ door bins**  
Slide the bins to meet different storage needs. To remove, lift and tilt. To replace, tilt the top and push down until locked in place.

**Door storage bin**  
The door bin can be removed by lifting it up over the support lugs. To replace, push down over the support lugs to lock in place.

**Bottle storage bin**  
Use the bottle bin for tall bottle storage. The bottle bin can be removed by lifting it up over the support lugs. To replace, push down over the support lugs to lock in place.

EBE5307 illustrated

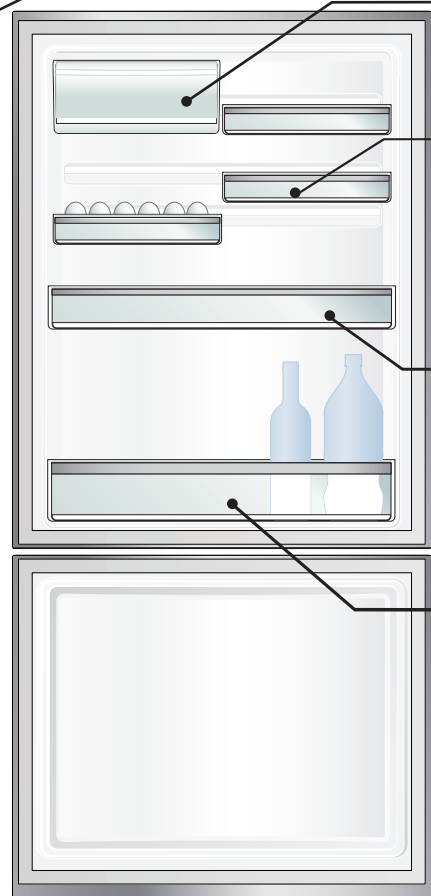
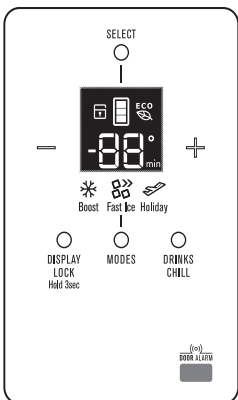
### Refrigerator/freezer control panel

From this panel you can control the temperature of the refrigerator and freezer compartments as well as setting the Boost function or resetting the door alarm.

For further information on how to use this feature refer to the section "About the User Interface".

# REFRIGERATOR FEATURES

## ICE & WATER

**LED lighting**  
Your refrigerator is fitted with LED lighting.

**Replaceable water filter**

**Glass shelves**  
The glass shelves improve visibility.

**Wire shelf**

**MultiZone™ deli drawer**  
Use the deli drawer to store foods like small goods, fresh or cooked meat and cheese, or as an additional crisper. The drawer will prevent strong food odours from impacting the rest of the refrigerator. To remove the deli drawer, pull it forward, then lift it up and pull it further forward.

**Auto humidity control**

**TasteLock™ crisper**  
Use the crisper to store vegetables, fruit or small goods.

**Automatic ice maker**  
Refer to the section "Using your Refrigerator" for details on using this feature.

**Freezer storage bin**  
Refer to the section "Using your Refrigerator" for details on removing, and using this feature.

**TasteGuard Deodoriser**

**Dairy compartment**  
This compartment can be used to store dairy.

**FlexStor™ door bins**  
Slide the bins to meet different storage needs. To remove, lift and tilt. To replace, tilt the top and push down until locked in place.

**Door storage bin**  
The door bin can be removed by lifting it up over the support lugs. To replace, push down over the support lugs to lock in place.

**Bottle storage bin**  
Use the bottle bin for tall bottle storage. The bottle bin can be removed by lifting it up over the support lugs. To replace, push down over the support lugs to lock in place.

EBE5367 illustrated

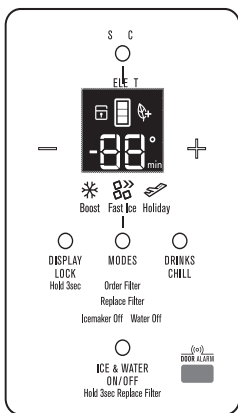

### Refrigerator/freezer control panel

From this panel you can control the temperature of the refrigerator and freezer compartments as well as setting the Boost function controlling the Ice Maker or resetting the door alarm.

For further information on how to use this feature refer to the section "About the User Interface".

Features may vary depending on model. Not all models will have features listed.

## FRENCH DOOR ICE & WATER

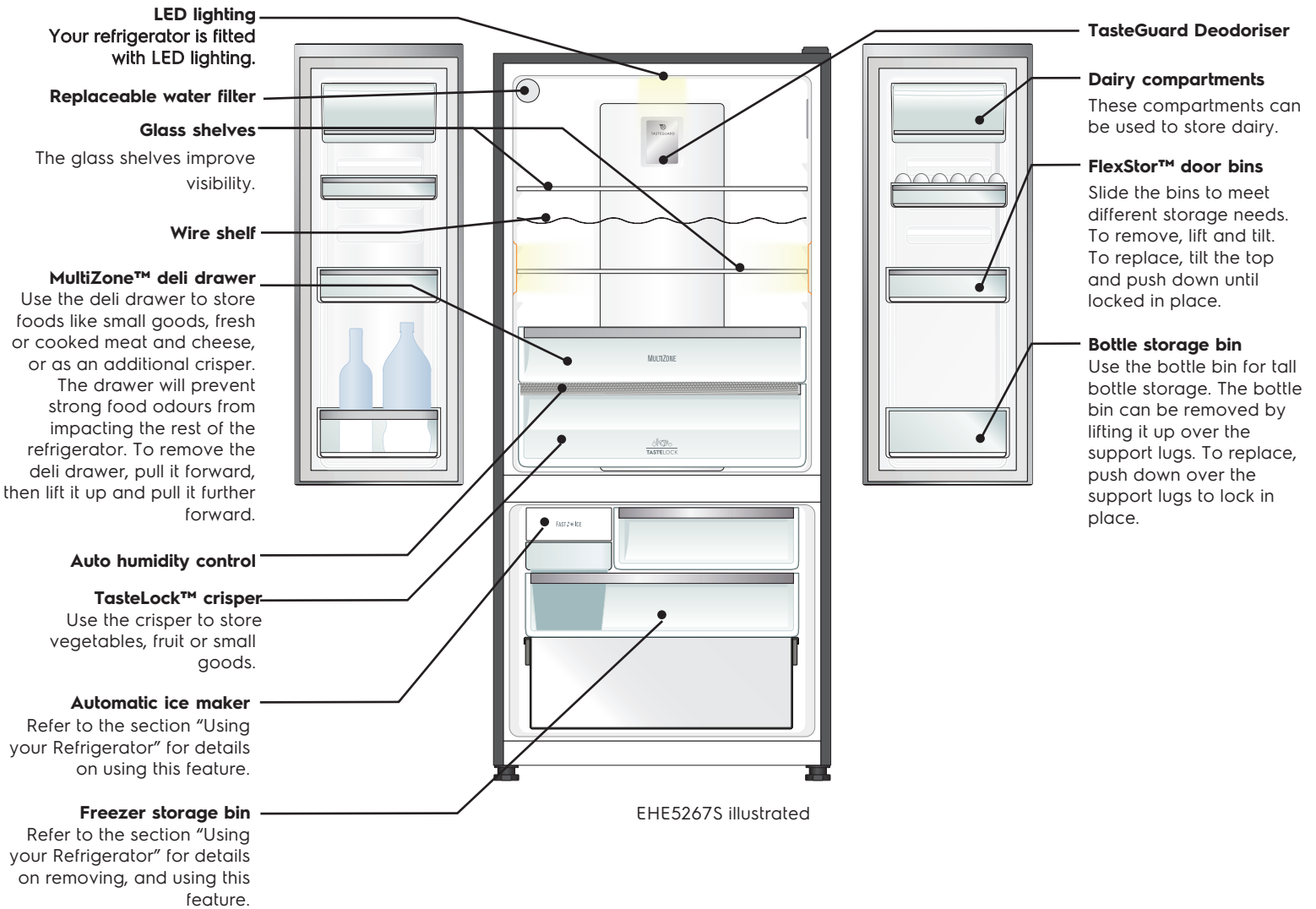

EHE5267S illustrated

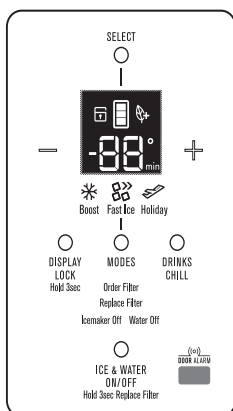

### Refrigerator/freezer control panel

From this panel you can control the temperature of the refrigerator and freezer compartments as well as setting the Boost function controlling the Ice Maker or resetting the door alarm.

For further information on how to use this feature refer to the section "About the User Interface".

Features may vary depending on model. Not all models will have features listed.

# REFRIGERATOR FEATURES

## SINGLE DOOR

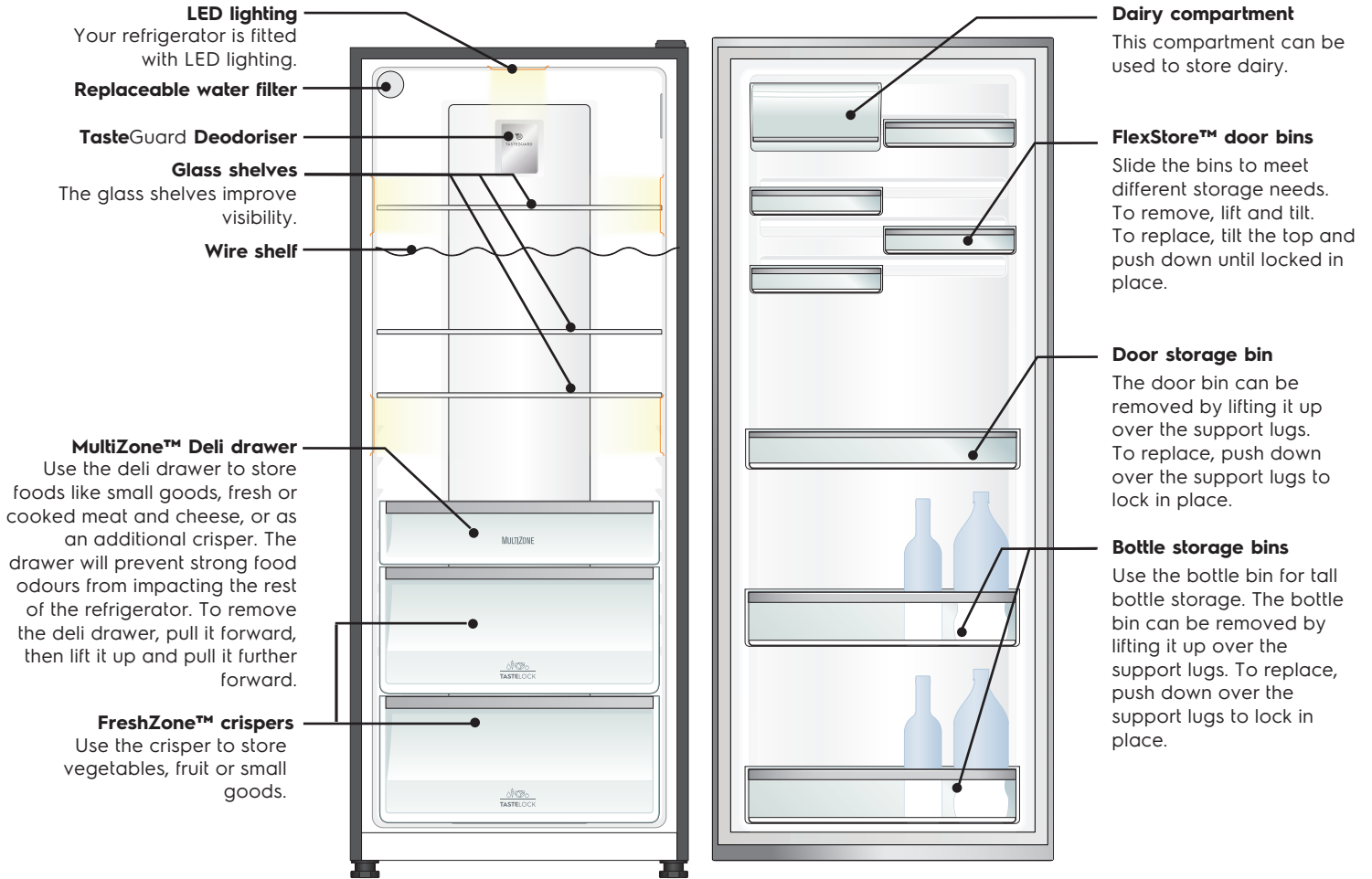

ERE5047 illustrated

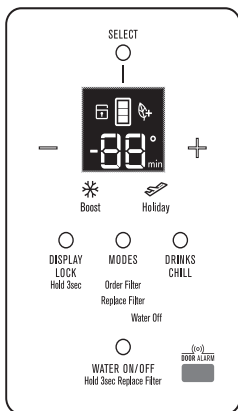

### Refrigerator control panel

From this panel you can control the temperature of the refrigerator compartments as well as setting the Boost function or resetting the door alarm.

For further information on how to use this feature refer to the section "About the User Interface".

Features may vary depending on model. Not all models will have features listed.



## FREEZER FEATURES

### SINGLE DOOR

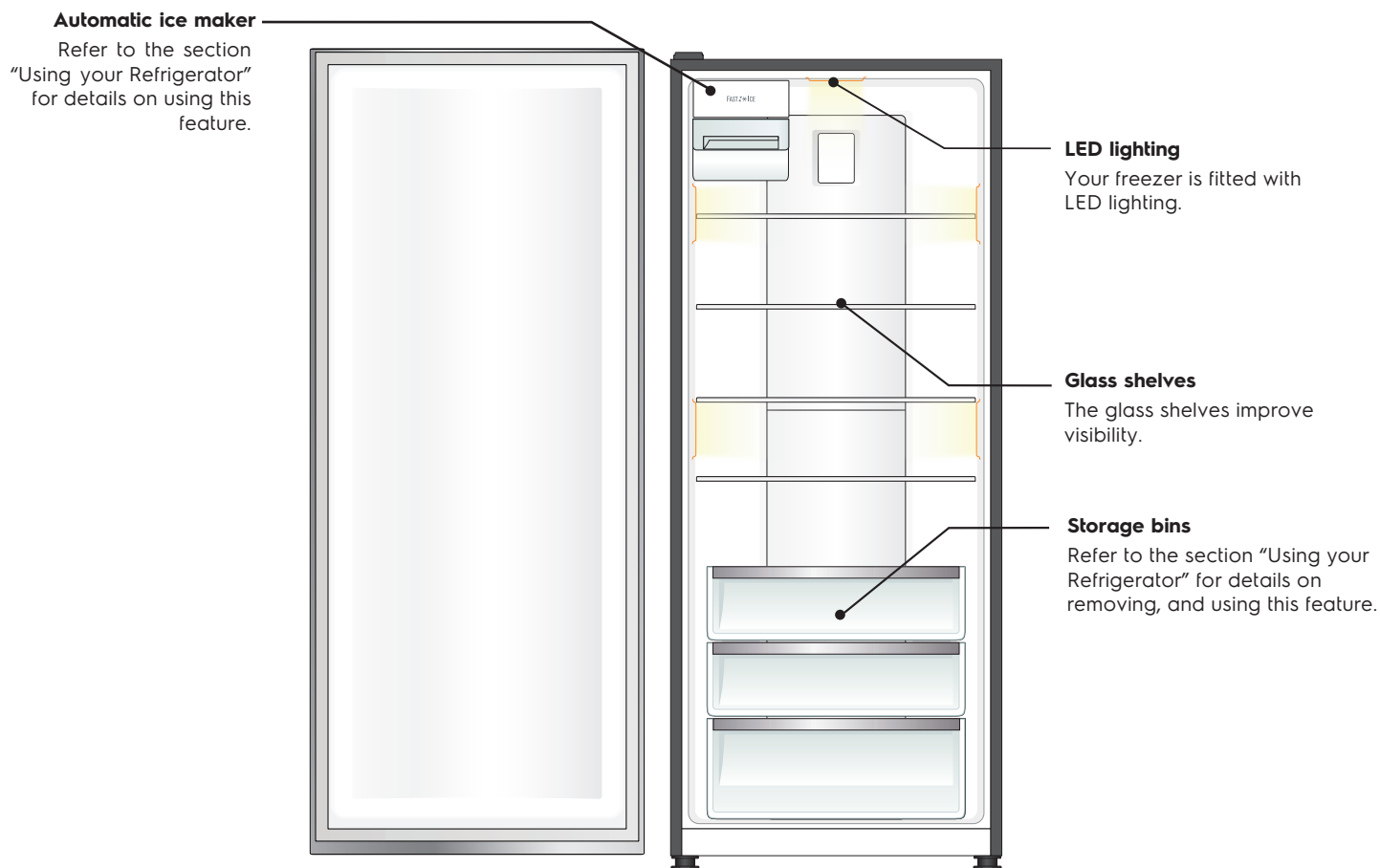

EFE4227 illustrated

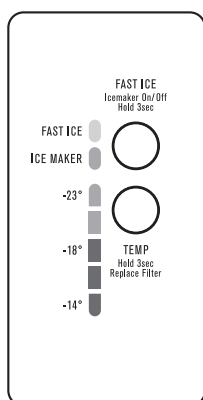

#### Freezer control panel

From this panel you can control the temperature of the freezer as well as setting the fast ice function or reset the door alarm.

For further information on how to use this feature refer to the section "About the User Interface".

Features may vary depending on model. Not all models will have features listed.

# INSTALLING YOUR NEW APPLIANCE

## UNPACKING



### ENVIRONMENT

Most of the packing materials are recyclable. Please dispose of those materials through your local recycling depot or by placing them in appropriate collection containers.

Important – check for any damages or marks. If you find the refrigerator is damaged or marked, you must report it within 7 days should you wish to claim for damage/ marks under the manufacturers warranty. This does not affect your statutory rights.

Clean your refrigerator thoroughly following the instructions in the “Cleaning” section and wipe off any dust that has accumulated during shipping.

## LOCATING THE REFRIGERATOR



### CAUTION

Automatic aerosol systems (such as insect control) should not be located adjacent to the product as the spray may cause long term damage to the external surfaces of the appliance.

Do not put the refrigerator in a location that is too cold or is unprotected, for example in a garage or on a veranda. The ambient temperature should be above 10°C.

Put the refrigerator in a dry place avoiding areas of high moisture or humidity.

Ensure the refrigerator is located on an even surface.

### Adequate ventilation around your refrigerator

The diagram below shows the recommended airspace to allow for ventilation of your refrigerator.

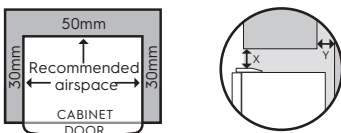

If you have a cupboard above the refrigerator with a rear gap of less than 100 mm (Y), recommended clearance at the top of the refrigerator increases from 30mm to 70mm (X) minimum.

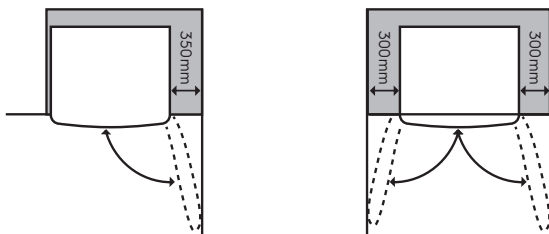

ETB4607, ETE5407  
EBE4507, EBE5307  
EBE5367, EFE4227  
ERE5047

EHE5267

When positioned in a corner area, spacing of at least 350mm (300mm for EHE5267 model) on the hinge side will allow the doors to open enough to enable the removal of bins and shelves.

*NOTE: Doors are designed to sit proud of cabinetry (not flush). The clearances shown above are the recommended minimum clearances.*

The clearance at the rear must not exceed 75mm.

## INSTALLING YOUR REFRIGERATOR

1. Roll the refrigerator into place.

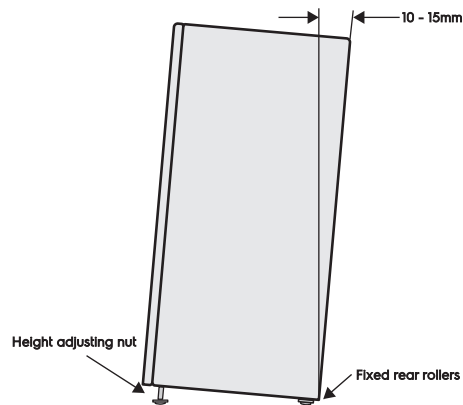

The rollers are designed for forward or backward movement only. They are not castors. Moving the refrigerator sideways may damage your floor and the rollers. Before moving your refrigerator ensure height adjusting nut and the stability foot are fully wound up off the floor.

2. Wind the large height adjusting nut under door hinge down until the refrigerator is tilted back by 10mm (see diagram).
3. Wind the large height adjusting nut on the handle side down until the refrigerator is level and stable. If you have difficulty winding the nut or height adjusting foot down, have someone tilt the refrigerator back so you have better access.

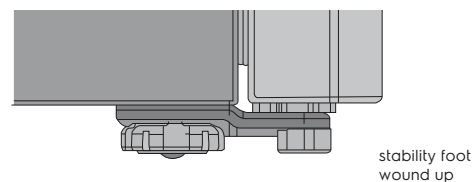

stability foot wound up

- Check the alignment of the refrigerator to the surrounding cupboards to see if it is level. You can adjust the level as detailed in step 2 and 3.

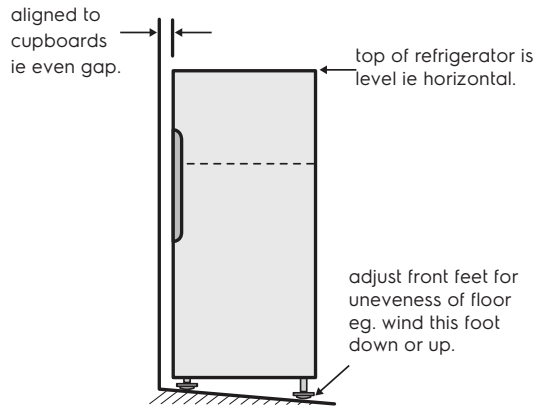

- If you find your refrigerator rocks from corner to corner, it means your floor is uneven. Find a piece of plastic or hardboard etc. and pack it firmly under the roller.
- You may now need to fine-tune the installation by repeating steps 3, 4 and 5.
- When you have the appliance in its final position, it needs to be stabilised. Wind the stability foot under the door hinge down to the floor until it just makes contact with the floor. Lift the front of the appliance to take the weight off the stability foot, then turn it half a turn further to ensure firm contact with the floor. Wind the large height adjusting nut back up to ensure all the weight is now on the front stability foot.
- Repeat step 7 for the stability foot on the handle side. Whenever you need to move the appliance, be sure to wind the feet back up so that the appliance can roll freely and be sure to reset it when reinstalling.

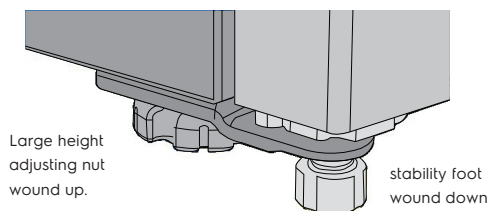

- Plug your refrigerator straight into its own power point and never use a double adapter. If you need to roll the refrigerator to get to the plug, remember to raise the stability foot first.
- Before you put any food in your refrigerator, it's recommended you leave it on for 2 or 3 hours to check it is running properly.

## FITTING THE HANDLES

For models with 'Pole' handles, the handles are supplied prepackaged with your refrigerator and will require fitting.

Refer to the instructions provided in the pack.

Congratulations! You have successfully installed your new refrigerator.

## ICE AND WATER MODELS

### ! WARNING

Connect to potable water supply only, if using tank or bore water in a model with an internal filter it is recommended to also use an external filter (not supplied).

The new hose sets supplied with the appliances must be used and old hose sets should not be reused.

Never connect the appliance to a hot water supply.

## WATER FILTER

It should not be used on water that is micro biologically unsafe or with water of unknown quality. The service life of the filter may be reduced in water supplies that contain an excess of particles or other impurities. Reduced flow rate is an indication that a new filter is required. Failure to replace the filter when required can affect the function of the ice maker. Service calls caused by a failure to replace the filter are not covered by warranty. Replacement water filters are available from Electrolux Home Products Spare Parts Centres and can be posted to you for your convenience (refer to spare parts contact numbers on the warranty page).

## Contents of installation kits

Filter Kit for single door freezer	Installation Kit Bottom mount & single door all refrigerator
1 x water filter with push fit connections	4 metres of water tubing
2 x mounting brackets and screws	1 x 1/2" tap fitting
4 + 1 metres of water tubing	
1 x 1/2" tap fitting	
2 x circlips	

## Water supply and plumbing

A drinkable water supply to suit a 1/2" tap fitting is required adjacent to the refrigerator. It is recommended that a licensed plumber install a new water supply outlet nearer to the appliance should the tubing supplied not be long enough. It is not recommended that the tubing be extended as this could adversely affect the flow of water to the ice maker or water dispenser. The water dispenser and automatic ice maker require a drinkable water supply with a pressure range of between 206kPa and 689kPa (30PSI and 100PSI). If the water supply is above 100psi a pressure limiting valve should be installed.

## ICE AND WATER MODELS (CONTINUED)

It is recommended that a noise reduction valve also be fitted in the water supply line. This will reduce water hammer and its effects from quick action household taps and fast acting valves on appliances.

The refrigerator water valve is pre-fitted with a push-fit connector for inserting the water tube. When the tap connection is other than 1/2", adapters can be purchased from plumbing supply stores or good hardware stores.

### INSTALLATION

Please read before beginning installation.

The water connection to your ice and water product can be self installed. However, it is recommended that you seek advice from a licensed plumber before commencing the installation.

#### **i** IMPORTANT

Check for water leaks at all water connection points in the first 2 to 3 hours after installation, and correct it in case of any water leak. Recheck after 24 hours; if a leak still occurs, it is recommended to contact a licensed plumber for advice.

Water is to be connected as per diagrams below.

#### Internal Filter

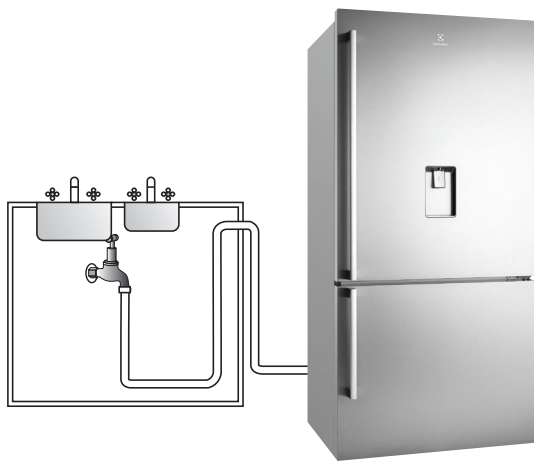

#### Single door freezer with external filter

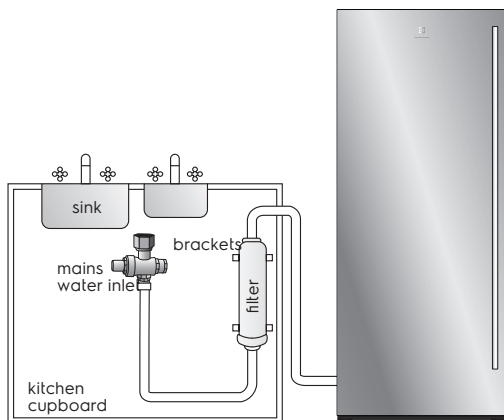

#### Step 1.

Ensure that the refrigerator is disconnected from power supply.

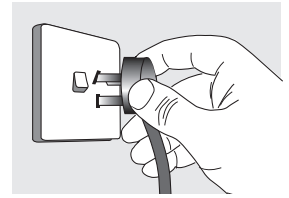

#### Step 2.

Connect tap fitting to water supply tap. Tap must be close to the refrigerator.

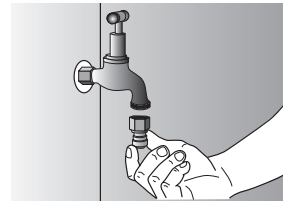

#### Step 3.

Push the tube into tap fitting past insertion mark.

(NOTE: step 4 to step 10 relate to models with an external filter only).

#### Step 4.

Install brackets for filter close to tap. Plan to leave as much tubing as possible behind the refrigerator to enable it to be moved easily for cleaning or service.

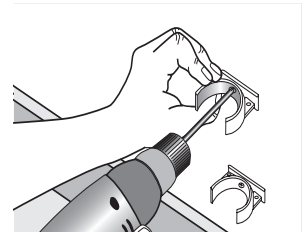

Do not screw the brackets into the refrigerator as this may void your warranty and permanently damage the refrigerator.

#### Step 5.

Write date on filter. The filter will need to be replaced every 6 months.

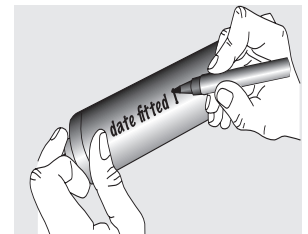

#### Step 6.

Extend the collar and clip a circlip around the collar at both ends of the filter.

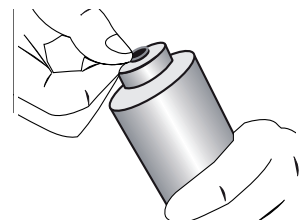

#### Step 7.

Fit the filter to brackets with water flow arrow pointing up.

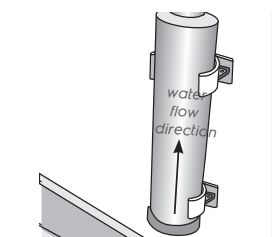

**Step 8.**

Push shorter tube into tap fitting past insertion mark.

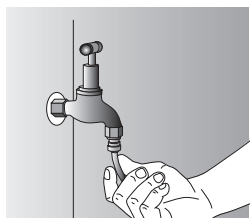
**Step 9.**

Push other end into filter INLET.

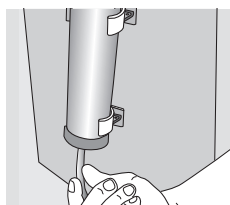
**Step 10.**

Connect remaining tube length into filter OUTLET. Water filter contains carbon dust which is non-toxic. Using a large container, turn on water and purge the residual carbon dust from filter until water runs clear.

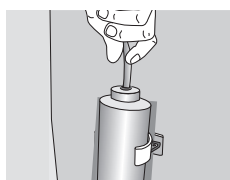
**Step 11.**

Connect other end of remaining tube length to inlet on bottom right hand side of refrigerator.

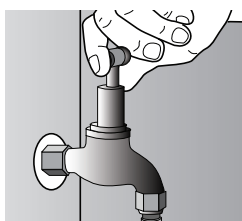
**Step 12.**

Turn on water and check all joints and tubes for leaks.

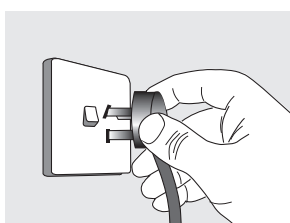
**Step 13.**

Reconnect the power.

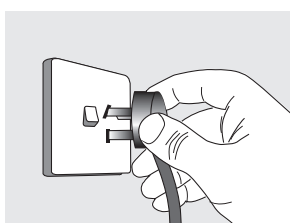
**Step 14.**

Switch On Water Dispenser (except model EFE4227.)

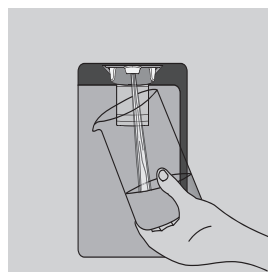

Using a large container, run the water dispenser to clear air from lines. This may take a few minutes. Purge and dispense a minimum of 2 litres of water. Initial water may

be black in colour. This is residual carbon dust from the filter and is non-toxic. If the water is slow to shut off or the dispenser is dripping, air may still be in the lines. Either purge more water through the system to remove this air or allow some time for the air to be removed over subsequent dispensing. For normal use, water dispenser will automatically shut off after 2 minutes of continuous operation.

**IMPORTANT**

As the water cut off is not instant, leave the glass under the dispenser briefly until the water has stopped flowing to avoid spills.

Clean and empty the dispenser drip tray regularly to avoid overflow.

If you have not used the dispenser for some time, discard the first seven or eight cups of water (contaminants could have settled in the water pipes).

**Step 15.**

Switch ON Ice Maker. (except model ERE5047)  
Refer to Controlling section

Once the refrigerator has been running for at least 24 hours remove the ice bin and dispose of the first few batches of ice to ensure that impurities have been flushed from the system.

Party Ice (except model EFE4227)

When the Ice Bin is removed from the cabinet the Auto Ice Maker will continue to dispense ice into the top freezer drawer.

**CAUTION**

Water dispenser should not be used for extended periods of time. After 2 minutes of continuous use the water dispenser will automatically shut off.

## ICE AND WATER MODELS (CONTINUED)

### CHANGING THE WATER FILTER

#### **i** IMPORTANT

- Always fit the filter as per manufacturer's instructions.
- If you need to replace water tube, only use approved water quality piping that meets the pressure requirements.
- Make sure your refrigerator is level to avoid uneven ice cubes.
- Replace filter at suggested intervals to avoid water/ice reduction and irregularities in taste.
- Remove and clean ice bin once a month, discarding unused ice cubes. This will ensure fresh, clean ice and smooth operation of your ice maker.
- Clean and empty the dispenser drip tray regularly to avoid overflow.

#### **!** WARNING

If you have not used the dispenser for some time, discard the first seven or eight cups of water and any ice that the ice maker produces in the first 24 hours (contaminants could have settled in the water pipes).

#### Internal Water filter

The water filter is located at the top left side of the fresh food compartment.

#### Replacing the water filter

You should change the water filter every six months to ensure the highest possible water quality.

If your refrigerator has not been used for a period of time (during a house move for example), change the filter before reinstalling the refrigerator.

It is not necessary to turn the water supply off to change the filter. Be ready to wipe up any small amounts of water released during the filter replacement.

1. Ensure that the ice maker is turned off (Diagram 1).
2. Remove the filter by turning anti-clockwise 180°.
3. Slide the old water filter cartridge straight out of the housing and discard it. (Diagram 2).
4. Unwrap the new filter cartridge and using the alignment guide, slide it gently into filter housing until it stops against the filter connection at the back of the housing. (Diagram 3).
5. Engage the filter by firmly rotating clockwise until the filter snaps into position (once engaged the filter cannot be rotated further). (Diagram 4).

6. Press a drinking glass against the water dispenser while checking for any leaks at the filter housing. Any spurts and sputters that occur as the system purges air out of the dispenser system are normal.
7. After filling one glass of water, continue flushing the system for about four minutes.
8. Turn on the ice maker. (Diagram 5).
9. When the filter has been replaced press and hold the 'Ice and Water' button for three seconds to reset the filter replace timer.

Diagram 1



Diagram 2

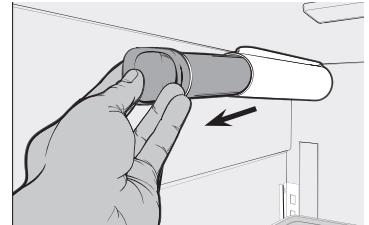

Diagram 3

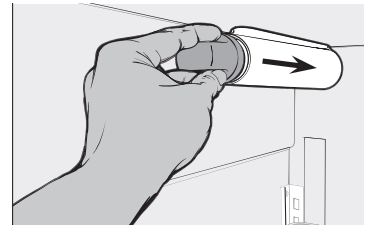

Diagram 4

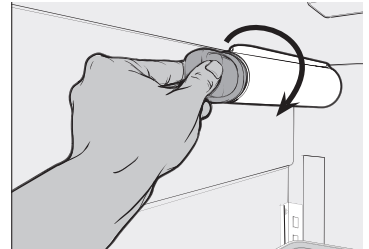

Diagram 5



## USING YOUR REFRIGERATOR

Refrigerators work by transferring heat from the food inside to the outside air. This operation makes the back and sides of the refrigerator feel warm or even hot particularly at start-up and on warm days – this is normal.

Avoid placing food against the air vents in the refrigerator as it affects efficient circulation. If the door is opened frequently, a light frosting will occasionally occur on the freezer's interior. This is normal and will clear after a few days. If the freezer door is accidentally kept open, a heavy frost will coat the inside walls and should be removed.

Your new refrigerator uses a high-speed compressor, along with other energy-efficient components, which may make unusual sounds and be more noticeable at night and quieter times. These sounds simply indicate your refrigerator is working how it should. They include:

- Compressor running noises;
- Air movement noise from the small fan motor;
- A gurgling sound, similar to water boiling;
- A popping noise, heard during automatic defrosting; and
- A clicking noise, prior to compressor start-up.

Further details can be found in the Troubleshooting Guide.

### **i** IMPORTANT

For top mount refrigerators (where the freezer is on top of the fresh food compartment).

- Don't place food forward of the ribs on the freezer floor, as it will keep the door open.

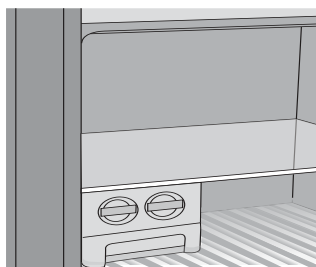

Ribs

For bottom mount refrigerators (where freezer is below the fresh food compartment):

- Ensure all freezer drawers and shelves are pushed back completely to prevent them from keeping the door open.

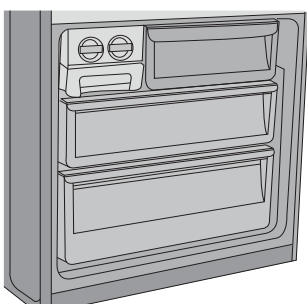

## REMOVING FEATURES

### AHC (Auto Humidity Control)

#### Auto Humidity Filter Cartridge

Auto Humidity Control automatically releases excess moisture & maintains optimal humidity for your fresh vegetables, maintaining the taste, texture and freshness.

Recommended to replace filter once a year\*

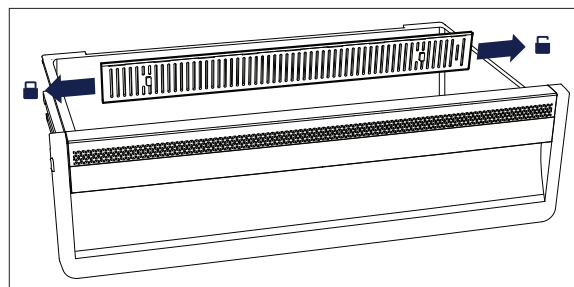

### Replacing Filter Cartridge

Auto Humidity Filter is located at the back of the crisper handle.

- Hold the tabs of the filter cartridge.
- Slide to the Right to release the filter.
- Replace a new filter and slide to the Left to lock in place.

### Freezer shelf

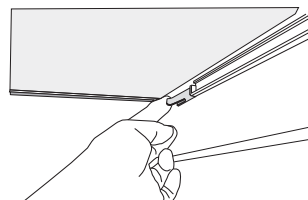

Remove the freezer shelf by lifting the catches on the right and left underside of the shelf to release the shelf then pull the shelf toward you.

### Drawers fitted with telescopic slides

To remove the drawer for cleaning.

1. Empty food from the drawer.
2. Remove the drawer by pulling it forward and lifting the front to unhook it from the slides. Once you have removed the drawer, ensure the slides are pushed back so they are fully closed.

### **!** WARNING

Never close the door while the telescopic slides are extended. This may damage the slide and/or refrigerator or cause the slide to become disengaged from the refrigerator.

## USING YOUR REFRIGERATOR (CONTINUED)

### To replace the drawer:

1. Ensure the telescopic slides are pushed in all the way.
2. Slide the drawer into place over the slides and push the bin in until it stops.
3. Drop drawer into position.

### Freezer bottom bin

To remove the bin, pull the drawer out until it is open all the way then lift bin out from the front of the bin. When refitting insert the rear of the bin first then lower into position.

When replacing the bins after cleaning, we recommend fitting the lower bin first.

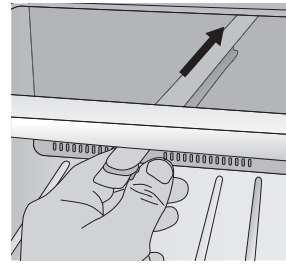
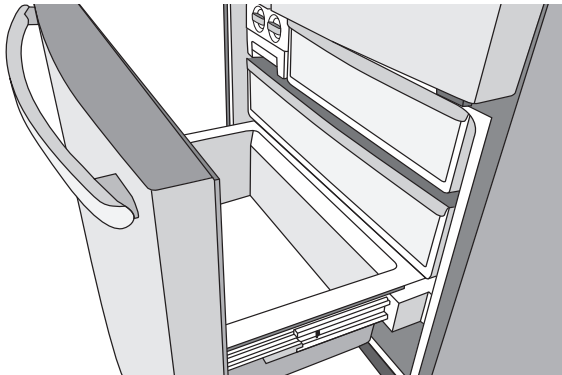

Insert into the slot at the rear of the shelf

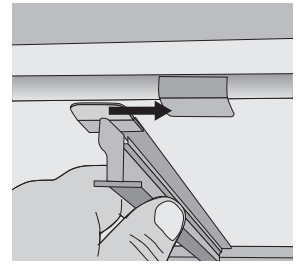

Then engage into the front of the shelf

1. Refit the runner into the rear of the shelf on the right hand side and then engage the front.
2. Fit the carriage by sliding it into the runners until the front of the carriage engages with the shelf.
3. Refit the ice tray and ice bin.

### WARNING

Fill the ice cube tray with potable water only.

### CAUTION

#### LED lighting

Your appliance is fitted with long life LED lighting. In the unlikely event the LED lights should fail, then the LED lights should be serviced by the manufacturer.

Refer to the warranty page for contact details.

### Twist and Serve Ice

Mounting the twist & serve dispenser to the other side of the freezer.

*NOTE: This is only possible on top mount models.*

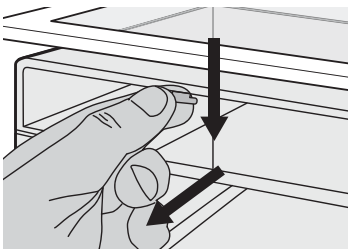

1. Remove the ice bin and ice cube tray. If the ice tray assembly is frozen to the carriage, simply squeeze the tray and shelf together to break the ice.
2. Before you remove The ice carriage, remember to disengage it from the glass shelf as it may result in damage to the assembly.
3. Remove the centre runner by disengaging it at the front of the shelf, and removing it from the rear.



## CONTROLLING

### ABOUT THE USER INTERFACE

The following pages explain the various functions of the user interface to help you better understand how to get the most out of your new refrigerator.



#### IMPORTANT

*NOTE: When you set a temperature, you set an average temperature for the whole refrigerator cabinet. Ensuring that you make only small adjustments and wait at least 24 hours to see if the new temperature is correct to your liking.*

*Checking the softness of ice cream is a good indication that your freezer is the right temperature, while checking the temperature of water kept in the refrigerator is a good way of checking the temperature of the food compartment.*

*Temperatures inside each compartment may vary, depending on how much food you store and where you place it.*

*High or low room temperature may also affect the actual temperature inside the refrigerator.*

# CONTROLLING (CONTINUED)

## FUNCTIONS OF THE USER INTERFACE

ETE4607, ETE5407, EBE4507,  
EBE5300, EBE5307

EBE5367, EHE5267

ERE5047

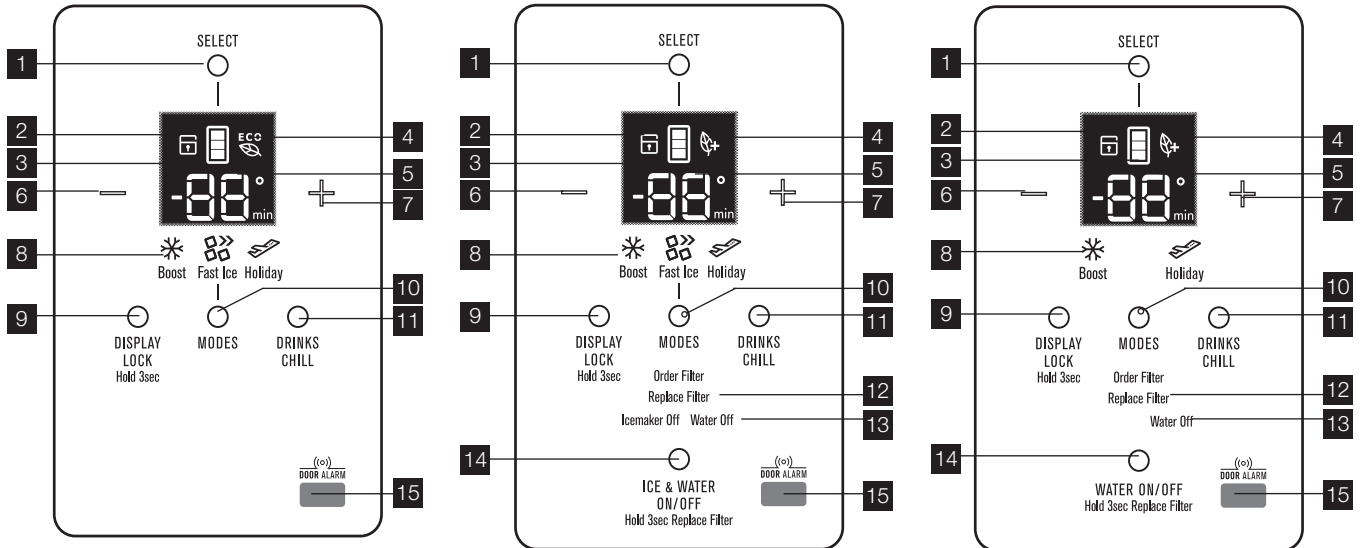

Button / Icon	Description	Primary Function
1	Compartment Selector button	Selects controllable compartment.
2	Lock Icon	Indicates if the user interface is locked.
3	Compartment Icon	Indicates controllable compartment.
4	ECO Icon	Indicates if the appliance is operating in its most energy efficient mode.
5	Digital display	Indicates temperature of selected compartment.
6	Decrease button	Decreases temperature of selected compartment.
7	Increase button	Increases temperature of selected compartment.
8	Mode indicators (Boost, Fast Ice, Holiday)	Indicates appliance operation mode.
9	Display Lock button	Selects lock state of user interface.
10	Mode select button	Selects operation mode of appliance.
11	Drinks Chill button	Selects drinks chill timer.
12	Filter status indicators	Indicates filter replacement timing.
13	Icemaker and Water on off indicators	Shows operational status.
14	Ice & Water or Water on/off button	Selects operation status.
15	Door sensor	Senses door state (open or closed).

### **i** IMPORTANT

The factory default settings for the refrigerator is "3° C" and "-18°C" for the freezer. If you want to change the temperature, remember to make only small adjustments and wait 24 hours to see if it's correct.

Function	Icon	Operation (depending on model)
Setting the temperature		Press button 1 to select compartment on icon 3 Press buttons 6 or 7 to adjust temperature up or down.
Boost mode Increases the chill rate of the refrigerator for 90mins before returning to pre-set mode.	 <b>Boost</b>	Press button 10 until the snowflake icon is illuminated. Boost mode can be deselected using button 10.
Fast Ice Decreases the freezer temperature to -23°C for 12 hours before returning to pre-set mode.	 <b>Fast Ice</b>	Press button 10 until the fast ice icon is illuminated. Fast ice mode can be deselected using button 10.
Holiday mode The refrigerator minimises defrosting to save energy when doors remain closed for an extended period.	 <b>Holiday</b>	Press button 10 until the holiday icon is illuminated. When holiday mode is enabled the temperature settings will be set to 3°C for the refrigerator and -18°C for the freezer. Holiday mode can be deselected using button 10 or opening the fridge door. When holiday mode is disabled the temperature settings will revert to the previous settings. Holiday mode can be deselected using button 10 or opening the fridge door.
Display Lock Deactivates the user interface controls.		To turn on/off press and hold button 9 for 3 seconds, the lock icon is illuminated when activated.
Drinks Chill Sets a timer for between 1 and 30 minutes as a reminder for when drinks are placed in the freezer for quick chill.		To turn on press button 11 and initial time of 20 mins will appear on digital display. To adjust time use buttons 6 and 7. Alarm will sound when time is finished. Press button 11 to turn off during or after countdown. The time taken to chill depends on the size of your bottle. Do not leave the bottle inside the freezer longer than the time needed for chilling.
Ice Maker on/off Enables/disables ice maker and water dispensing features.	<b>Icemaker Off</b>	To enable/disable press button 14 to cycle through on/off modes. Indicator 13 will illuminate when either the ice maker or water dispenser are deactivated.
Ice Cube Size Ice cube size can be adjusted for personal preference or to suit supply water pressure.		Press and hold buttons 10 and 14 for 3 seconds. Press button 6 to cycle through cube sizes, small (S), medium (M), large (L) & extra large (EL). Medium symbol shown. To confirm the setting press button 10. The display will return to the preset mode after 45 seconds.
Sabbath Mode Disables all lights and other electrical activity from occurring when the refrigerator door is opened.		To enable and disable Sabbath mode, press and hold buttons 7 and 9 for 3 seconds. When enabled/disabled an alarm will beep 4 times and "Sb" will appear on digital display when active.
<b>Indicator</b>	<b>Icon</b>	<b>Operation</b>
Eco Mode Enabled when appliance set to energy efficient operating temperatures.		ECO icon automatically appears when refrigerator is set between +3°C and +7°C and freezer is set between -14°C and -18°C
Order Filter Reminder when the water filter periodically requires replacement.	<b>Order Filter</b> <b>Replace Filter</b>	Order filter icon will appear as a reminder to order a replacement water filter. When the filter has been replaced press and hold button 14 for 3 seconds to reset the filter replacement timer.
Replace Filter Reminder when the water filter requires replacement.	<b>Order Filter</b> <b>Replace Filter</b>	Replace filter icon and alarm will activate as a reminder to replace the water filter. Mute alarm for 1 week by pressing any button on the user interface. When the filter has been replaced press and hold button 14 for 3 seconds to reset the filter replacement timer.

### IMPORTANT

The factory default settings for the refrigerator is "3°C" and "-18°C" for the freezer. If you want to change the temperature, remember to make only small adjustments and wait 24 hours to see if it's correct.

## CONTROLLING (CONTINUED)

### THE FREEZER USER INTERFACE

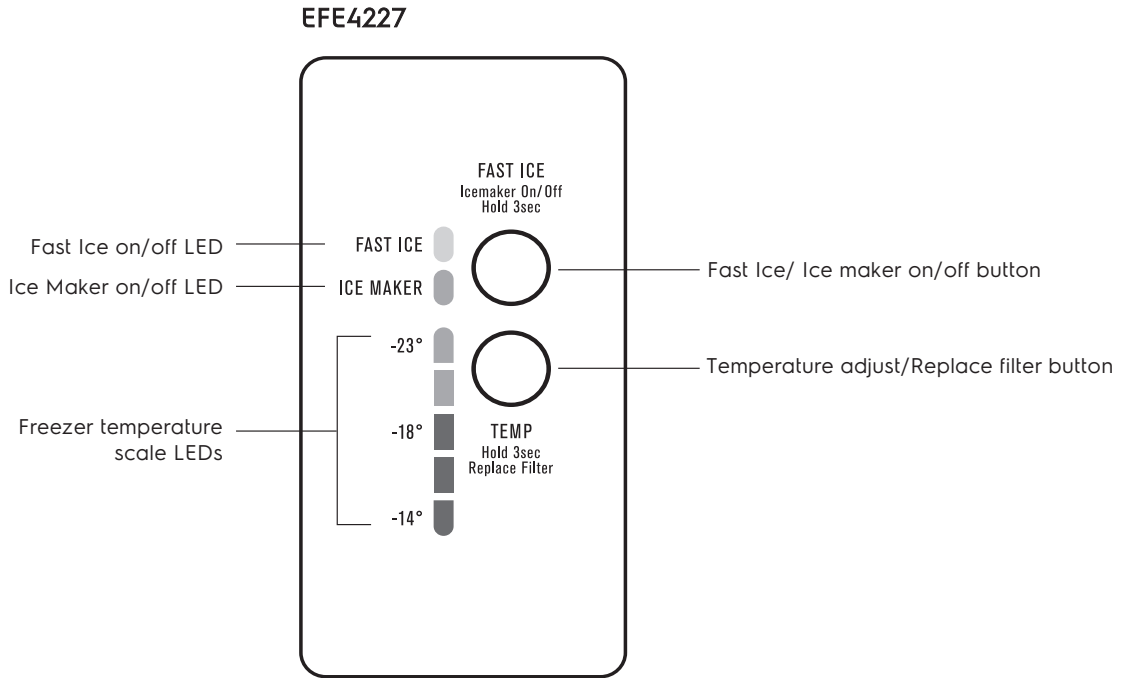

Description	Operation / Primary Function
Fast Ice on/off LED	Indicates the status of the Fast Ice function.
Ice Maker on/ off LED	Indicates the status of the Ice Maker function.
Fast Ice/Ice Maker button	Use the Fast Ice function when you add a large amount of food to the freezer compartment; <ul style="list-style-type: none"> <li>Press the 'Fast Ice/Ice Maker' button. The Fast Ice icon will flash indicating that the Fast Ice is active. and the compressor will run continuously for 12 hours</li> <li>After 12 hours the freezer will automatically return to normal mode.</li> <li>The Fast Ice function can be cancelled anytime by pressing the button again.</li> </ul>
Turning Automatic Ice Maker On/Off	<ul style="list-style-type: none"> <li>Press and hold the 'Fast Ice/Ice Maker button for 3 seconds. The Ice Maker LED will activate indicating that the Ice Maker is active.</li> <li>Ice Maker can be turned off at any time. Press and hold the 'Fast Ice/Ice Maker button for 3 seconds.</li> </ul>
Ice cube size Ice cube size can be adjusted for personal preference or to suit supply water pressure	<div style="display: flex; align-items: center;"> <div style="margin-right: 10px;"> <p>-23° ← Extra large</p> <p>-18° ← Large</p> <p>-14° ← Medium</p> <p>-14° ← Small</p> </div> <div> <p>Press "Temp" and "Fast Ice" buttons together for 3 seconds within first 12 seconds of appliance starting. Four pre-set ice cube sizes can be selected by the user. Press "Fast Ice" button to scroll through options and press "Temp" button to confirm.</p> </div> </div>
Freezer temperature scale icons	Indicates the temperature setting of the freezer compartment.
Temperature adjust button	<p>Press any button to awaken control.</p> <p>Press the 'Temp' button to decrease the compartment temperature. Once the coldest temperature is reached the display will return to the warmest setting with the next press.</p>
Replace filter Reminder for when the water filter requires replacement.	<p>Replace filter alarm will activate as a reminder to replace the water filter.</p> <p>An alarm will sound and the Fast Ice on/off icon will flash. Hold "TEMP" button for 3 seconds to reset.</p>

**i IMPORTANT**

The factory default settings for the freezer is "-18°C". If you want to change the temperature, remember to make only small adjustments and wait 24 hours to see if it's correct.

## ERROR CODES & ALARMS

### Alarms

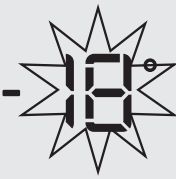
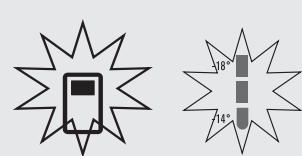
Alarm Icon	What it means	Operation
	<p><b>Freezer Temperature Alarm</b> (Except Single door freezer)</p> <p>Activates if the freezer temperature is 10°C over set temperature for a period of 50 minutes (except during a defrost).</p> <p>An alarm will sound the temperature icons will flash.</p>	<p>To deactivate the alarm for 50 minutes press any button.</p> <p>To deactivate alarm for 12 hrs on the ice &amp; water model press and hold Select Mode for 10 seconds for non ice and water models press and hold any button for 10 seconds.</p>
 <p>All Freezer Model</p>	<p><b>Door Alarm</b></p> <p>Activates if the refrigerator or freezer doors are left open for longer than 2 minutes.</p> <p>An alarm will sound the affected compartment icon will flash and the temperature and icons will fade on and off.</p>	<ul style="list-style-type: none"> <li>Alarm will sound and icon will flash indicating which door is open. (Ice &amp; water models)</li> <li>To silence the alarm for 8 minutes while the door is open press any button (the icons will continue to flash until door is closed).</li> </ul>

### Error codes

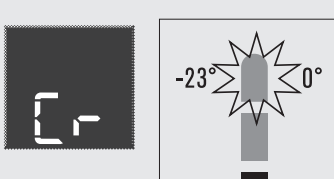
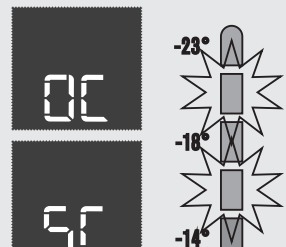
Error code	What it means...	What to do...
<p><b>Communication Error</b></p> 	<p>If you see this icon displayed (electronic display models) or the top temperature icon is flashing it means that the control has lost contact with the main control board.</p> <p>The appliance will operate at its last known setting, all auxiliary functions will not work.</p>	<p>Turn the unit off at the power point for 5 minutes and then turn it back on.</p> <p>Under most circumstances this will reset the display enabling normal function to continue.</p> <p>If the error re-occurs then call for service.</p>
<p><b>Sensor</b> - Open Circuit /Short Circuit</p> 	<p>If you see this icon displayed (electronic display models) or any combination of the second and fourth temperature icons are flashing it means that an error has been detected on a sensor.</p> <p>The refrigerator will run in a default cycle to prevent food spoilage.</p>	<p>Call for service.</p>

## GENERAL INFORMATION

### CLEANING YOUR REFRIGERATOR

#### WARNING

**BEFORE CLEANING:** Turn the refrigerator off at the power point and unplug the cord to prevent any chance of electrocuting yourself.

Your stainless steel refrigerator is manufactured from mark-resistant stainless steel. This stainless steel has a special advanced protective coating that eases the removal of marks such as fingerprints and water spots. To keep its appearance, clean it regularly with lukewarm soapy water and a soft cloth.

#### CAUTION

Never use stainless steel cleaners, abrasive pads or other cleaners that will scratch the surface. Damage to the appliance after delivery is not covered by your warranty.

#### Interior

Clean the inside of your refrigerator regularly with a soft cloth, unscented mild soap and lukewarm water. Thoroughly dry all surfaces and removable parts and avoid getting water on the controls. Replace removable parts, plug power cord in and switch the power on before returning the food.

#### Ice and Water

Clean the components of the ice maker /water dispenser regularly with a soft cloth, unscented mild soap and rinsing thoroughly with lukewarm water.

For further information on the care and cleaning of your Icemaker, Ice dispenser or water dispenser refer to the section "Ice and Water Models"

#### Door seals

Always keep door seals clean by washing them with a mild detergent and warm water, followed by a thorough drying. Sticky food and drink can cause seals to stick to the cabinet and tear when you open the door.

Never use hot water, solvents, commercial kitchen cleaners, aerosol cleaners, metal polishes, caustic or abrasive cleaners, or scourers to clean your refrigerator.

Many commercially available cleaning products and detergents contain solvents that will damage your refrigerator. Use only a soft cloth with an unscented mild soap and lukewarm water.

#### CAUTION

To clean a crisper or freezer bin with telescopic extension slides, simply wipe with a damp cloth and warm soapy water.

Never immerse the cover in water, as this could affect the operation of the slide.

#### Switching off your refrigerator

If you switch off your refrigerator for an extended period, follow these steps to reduce the chances of mould:

1. Remove all food.
2. Remove the power plug from the power point.
3. Thoroughly clean and dry the interior.
4. Ensure that all the doors are wedged open slightly for air circulation.

## FOOD STORAGE GUIDE

Category	Product	Refrigerator	Freezer	Storage Tips
<b>Meat</b>	Sausages and Mince	1-2 Days	2-3 Months	Keep cold meat at the back of the refrigerator where it is coldest.
	Chops and Steak	3-4 Days	4-6 Months	
	Cold Meats	3-5 Days	4-6 Months	Plastic can cause meat to sweat if stored in refrigerator for more than a day.
	Cuts for roasting	3-5 Days	12 Months	Cuts for roasting can take up to 48 hours to defrost properly. Transfer frozen cuts to the refrigerator 2 days before use.
<b>Poultry</b>	Chicken	1-2 Days	2 Months	If poultry takes on a smell or colour you are unsure about it is best to throw it out.
	Roast Chicken	3-5 Days	12 Months	
	Eggs	6 Weeks	Not Suitable	Whole eggs are not suitable for freezing, slightly beaten eggs may be frozen for four months.
<b>Seafood</b>	Whole fish and fillets	2-3 Days	2 Months	Store in an airtight container or foil.
	Lobster and crabs	1-2 Days	2 Months	
	Prawns	1-2 Days	2 Months	Never freeze prawns in salty water as this will dehydrate the flesh.
<b>Dairy</b>	Milk	Until Expiry Date	Not Suitable	If dairy takes on a smell or colour and you are unsure about it, it is best to throw it out.
	Yoghurt	7- 10 Days	Not Suitable	
	Hard Cheeses	2 Weeks – 2 Months	2 Months (Grated)	Depending on the variety hard cheese can last from 2 weeks to 2 months.
	Soft Cheeses	1-2 Weeks	Not Suitable	
	Butter	8 Weeks	12 Months	
<b>Fruit &amp; Vegetables</b>	Every fruit and vegetable has a different shelf life. Some stay fresh for a couple of days e.g beans, others can last for a couple of months e.g. onions.		8-12 Months When freezing chop and blanch in small portions.	Keep vegetables in the crisper and away from the air vents to avoid freezing.  If you wash fruit and vegetables before storing them make sure they are dry or wrap in absorbent paper before storing in the refrigerator as this can make them susceptible to rotting.  Try to keep fruit and vegetables separated as fruits that give off high levels of ethylene (the ripening agent) can prematurely ripen and spoil surrounding vegetables



### IMPORTANT

Please note, use this information as a guide only, actual storage times will vary depending on how you use your refrigerator, climatic conditions and the freshness of the food.

## GENERAL INFORMATION (CONTINUED)

### TROUBLESHOOTING

#### Appliance does not operate at desired temperature

In a modern frost free refrigerator / freezer, cold air is circulated around the various compartments through air vents using a high efficiency fan.

Concern	What to do
Refrigerator is too warm.	Ensure food is allowed to cool before placing inside the refrigerator.
	Ensure the appliance is set up as per instructions on page 11.
	Ensure that contents are not obstructing the cooling vents.
	Ensure the door is not held open or is being opened too frequently.
Freezer is too warm.	Adjust temperature to a colder setting.
	Ensure food is allowed to cool before placing inside the freezer.
	Ensure the appliance is set up as per instructions on page 11.
	Ensure that contents are not obstructing the cooling vents.
Food is freezing in the refrigerator.	Adjust temperature to a warmer setting.
	Ensure that fruit and vegetables are stored in the crisper. Items with a high water content should not be placed near the cooling vents.
Unable to change temperature settings.	Refer to function guide in Controlling Your Refrigerator.
	Ensure that user interface is in "awake" mode before trying to adjust temperature settings.

#### Appliance noise

Your new refrigerator may make sounds that your old one didn't make. Because the sounds are new to you, you might be concerned about them. Most of the new sounds are normal. Hard surfaces, like the floor, walls and cabinets, can make the sounds seem louder than they actually are. The following describes the kinds of sounds and what may be making them.

Concern	What to do
Motor noise (compressor).	Nothing. This is normal as your new refrigerator uses a variable speed compressor and fan that at start up and on warm days runs at a high speed to provide additional cooling.
	When less cooling is required the compressor and fan will run at a lower speed. Note that the compressor noise may seem louder at the start of the on cycle.
A clicking noise heard just before the compressor starts.	Nothing. This is normal as your new refrigerator has an automatic switching action of the temperature control, turning the compressor on and off.
Occasional gurgling, similar to water boiling.	Nothing. As each refrigeration cycle ends, you may hear a gurgling sound due to the refrigerant flowing in your refrigerator system.
Airflow noise.	Nothing, this is normal as your new refrigerator uses high efficiency fans to circulate air. Fan speed and noise may increase during periods of heavy usage or hot weather.
Rattling and other noises.	Ensure that the cabinet is level and stable, refer to Installation Instructions on page 11.
	Check the surrounds of the appliance to ensure there is nothing touching or placed on top of the appliance.
	Ensure that contents of the appliance are not placed in such a way that they are vibrating (such as bottles).

#### Crisper Operation

Concern	What to do
Excess moisture build up in crisper. <i>It is normal for there to be some moisture and humidity in the crisper bin.</i>	Ensure that the crisper is not over packed.
	Adjust crisper humidity slides.
Crisper bin can not be removed.	If crisper bin interferes with the door bins, remove door bins before removing crisper.
	Position cabinet so that the door can be fully opened.
Freezing items in the crisper.	Adjust temperature to a warmer setting.



## TROUBLESHOOTING

### Refrigerator operation

Concern	What to do
Appliance will not run	Ensure that the cord is plugged into a live power outlet and outlet is switched on.
It is normal for the freezer fan not to operate during the automatic defrost cycle, or for a short time after the appliance is switched on.	Ensure that the household circuit breaker has not tripped or that the fuse has not blown.
	The appliance maybe in defrost mode, check again in half an hour.
Compressor motor seems to run too long	Ensure that the doors are not held open.
At normal room temperatures, expect your motor to run about 40% to 80% of the time. Under warmer conditions, expect it to run even more often.	Check that large amounts of warm food have not just been placed inside the appliance.
	Note that the appliance will run more than normal just after you install it or when adjusting to temperature setting changes.
The variable speed compressor and fan that at start up and on warm days runs at a high speed to provide additional cooling. When less cooling is required the compressor and fan will run at a lower speed.	
The exterior of the appliance is warm or hot to touch	Ensure the appliance has the external clearances recommended in the section "Installing your new appliance".
This is normal because the appliance transfers heat from the inside out through the outer panels and the divider between the doors.	The exterior of the cabinet will be much warmer on warmer days it may even feel hot to touch, as the appliance is working harder.
User interface will not respond	Check that the user interface is in awake mode, refer to section "About the user interface".
To ensure settings are not accidentally changed the user interface will go into sleep mode when not in use.	Check that the user interface is not locked, refer to section "About the user interface".
	If the user interface is frozen turn the appliance off for five minutes for the memory to clear, then turn back on.
Press any button to wake user interface.	Check that the user interface is not in Sabbath Mode, refer to control instructions. (I&W models only).
Alarms sounding	Check that all doors are fully closed.
	Ensure that the over temperature alarm is not being activated by hot food placed in the freezer.
	Check if the drinks timer has ended, refer control instructions.
	Check if the Filter Replacement alert is activated, refer control instructions. (I&W models only)
Frost build up	Check that all doors are fully closed.
	Ensure that the doors are not opened too often.
	Ensure that the return air vents are not blocked with packaging.
	Ensure the seals are clean and not obstructed.
Odours	The interior may need cleaning, refer to cleaning guide.
	Ensure that food is stored correctly as some food, containers and wrapping can produce odours.
	Check appliance for old or unusual food.
Lights not working	Ensure that the cord is plugged into a live power outlet and outlet is switched on.
	Ensure that the household circuit breaker has not tripped or that the fuse has not blown.
	Check that the user interface is not in Sabbath Mode, refer to control instructions.
	Close and re-open the door. When door has been open for 5 minutes the lights fade to 50% then after 7 minutes they will turn off.
The LED lighting is designed to dim automatically if the door is left opened for more than 5 minutes and turn off completely if the door is open for more than 7 minutes. Closing the door will reset the timer.	
The LED lighting is also designed to turn on gradually.	

## GENERAL INFORMATION (CONTINUED)

### TROUBLESHOOTING

#### Door operation

Concern	What to do
Freezer door pops open.	<p>This is normal and should re-close. This happens when the refrigerator door is closed too quickly.</p> <p>If the freezer door stays open, it indicates that the appliance needs to be tilted backwards a little further. Refer to section "Installing your new appliance".</p>
Self close not working.	<p>Check if your appliance has self closing hinges as not all models do.</p> <p>It indicates that the appliance needs to be tilted backwards a little further. Refer to section "Installing your new appliance".</p>
Door not sealing properly	<p>Ensure there is nothing that is preventing the door from closing such as appliance contents or items placed near the appliance.</p> <p>Ensure that the crisper/freezer bin is closed completely. Refit if required as referred to in the section "Using your refrigerator".</p> <p>Ensure the appliance is set up as per recommendations.</p>
Door difficult to open and close	<p>If the door is difficult to open just after you have closed it this is due to the pressure equalising, the door will open normally after a few minutes.</p>

#### Automatic Ice maker system

Concern	What to do
Ice maker does not produce ice or not enough ice	<p>Ensure that the cord is plugged into a live power outlet and outlet is switched on.</p>
The icemaker is designed to produce a tray of ice approximately every 3 hours, depending on room temperature and water temperature..	<p>Ensure that water is connected and turned on and there are no kinks in the water line.</p> <p>Ensure that the Ice Maker is switched on at the user interface refer to "About the User Interface" for details.</p> <p>Check that the water filter is not blocked or out of date.</p> <p>Check the water supply flow rate.</p> <p>If the freezer compartment is too warm, refer to "freezer is too warm" then wait 24 hours for the freezer to reach ideal temperature.</p> <p>Turn the unit off at the mains and leave for 2 minutes then turn the appliance back on (this will reset the icemaker unit). Check for ice production after 24 hours.</p> <p>Check that there is no obstruction under the ice maker and ensure the ice bin is fitted correctly.</p>
Ice has bad odour or taste	<p>Cover food to ensure ice does not absorb foreign odours.</p> <p>Check that the water filter is not out of date.</p> <p>Interior of appliance or ice bin may require cleaning, refer to "Cleaning your refrigerator".</p> <p>Discard stale ice monthly and allow ice maker to produce a fresh supply.</p>

#### If you still require service

If you have a problem, and the problem persists after you have made the checks mentioned, contact your nearest Electrolux approved Service Centre or the dealer you bought the refrigerator from. Be ready to quote the model number, the 9-digit PNC and 8-digit serial number, which is stated on the label inside the refrigerator compartment.

NOISES

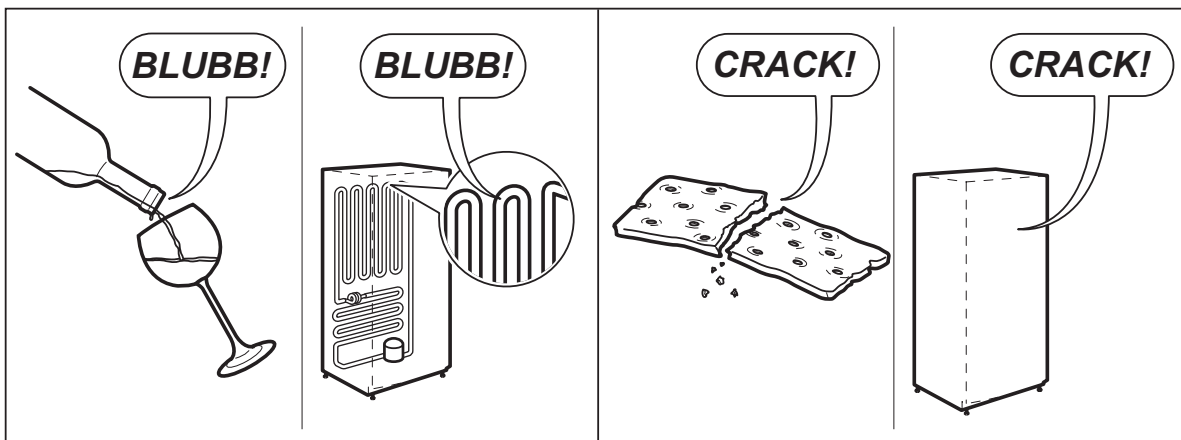
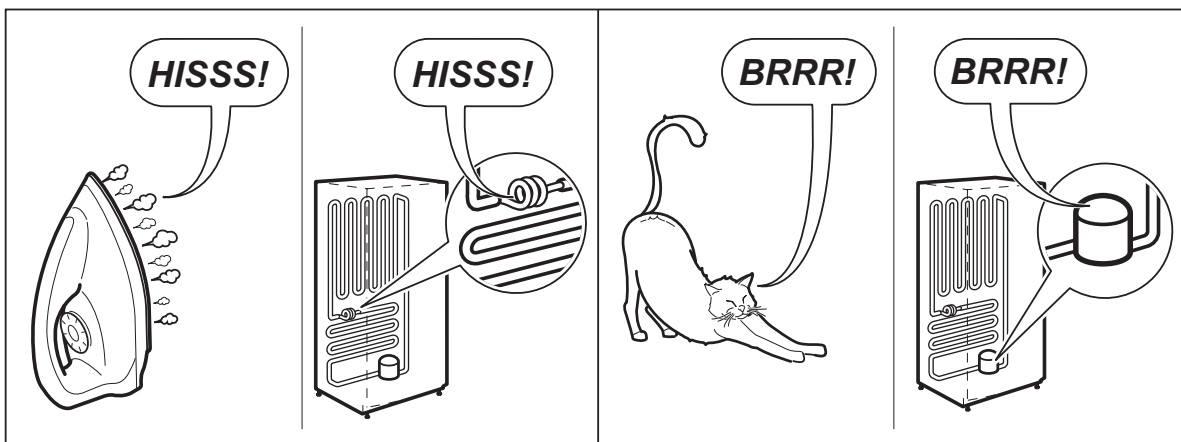
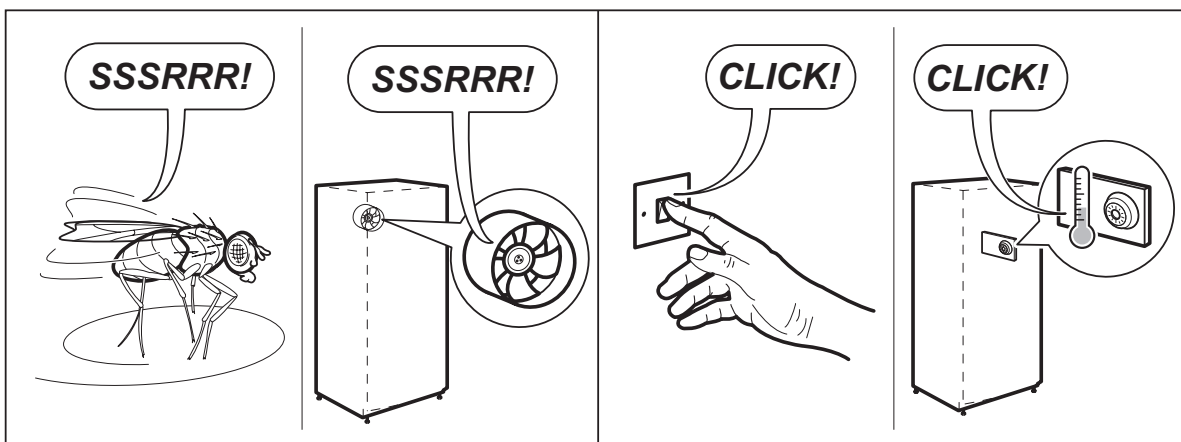
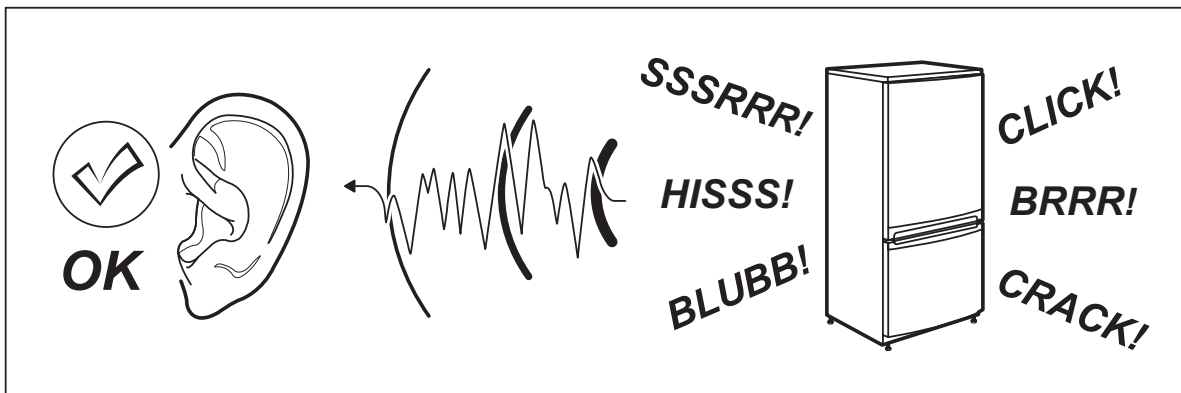







**This document sets out the terms and conditions of the product warranties for Electrolux Appliances. It is an important document. Please keep it with your proof of purchase documents in a safe place for future reference should there be a manufacturing defect in your Appliance. This warranty is in addition to other rights you may have under the Australian Consumer Law.**

**1. In this warranty:**

- (a) 'ACL' or 'Australian Consumer Law' means Schedule 2 to the Competition and Consumer Act 2010;
- (b) 'Appliance' means any Electrolux product purchased by you and accompanied by this document;
- (c) 'ASC' means Electrolux's authorised serviced centres;
- (d) 'Electrolux' is the brand controlled by Electrolux Home Products Pty Ltd of 163 O'Riordan Street, Mascot NSW 2020, ABN 51 004 762 341 in respect of Appliances purchased in Australia and Electrolux (NZ) Limited (collectively "Electrolux") of 3-5 Niall Burgess Road, Mount Wellington, in respect of Appliances purchased in New Zealand;
- (e) 'Warranty Period' means the period specified in clause 3 of this warranty;
- (f) 'you' means the purchaser of the Appliance not having purchased the Appliance for re-sale, and 'your' has a corresponding meaning.

**2. Application:** This warranty only applies to new Appliances, purchased and used in Australia or New Zealand and is in addition to (and does not exclude, restrict, or modify in any way) other rights and remedies under a law to which the Appliances or services relate, including any non-excludable statutory guarantees in Australia and New Zealand.

**3. Warranty Period:** Subject to these terms and conditions, this warranty continues for in Australia for a period of 24 months and in New Zealand for a period of 24 months, following the date of original purchase of the Appliance. Specific components are warranted against manufacturing defects in Australia and New Zealand for the periods listed below;

- Compressor – Further 3 years parts only,
- External Condenser – Further 3 years parts only
- Evaporator – Further 3 years parts only
- Drier – Further 3 years parts only

**4. Repair or replace warranty:** During the Warranty Period, Electrolux or its ASC will, at no extra charge if your Appliance is readily accessible for service, without special equipment and subject to these terms and conditions, repair or replace any parts which it considers to be defective. Electrolux may, in its absolute discretion, choose whether the remedy offered for a valid warranty claim is repair or replacement. Electrolux or its ASC may use refurbished parts to repair your Appliance. You agree that any replaced Appliances or parts become the property of Electrolux.

**5. Travel and transportation costs:** Subject to clause 7, Electrolux will bear the reasonable cost of transportation, travel and delivery of the Appliance to and from Electrolux or its ASC. Travel and transportation will be arranged by Electrolux as part of any valid warranty claim.

**6. Proof of purchase** is required before you can make a claim under this warranty.

**7. Exclusions:** You may not make a claim under this warranty unless the defect claimed is due to faulty or defective parts or workmanship. This warranty does not cover:

- (a) light globes, batteries, filters or similar perishable parts;
- (b) parts and Appliances not supplied by Electrolux;
- (c) cosmetic damage which does not affect the operation of the Appliance;
- (d) damage to the Appliance caused by:
  - (i) negligence or accident
  - (ii) misuse or abuse, including failure to properly maintain or service;
  - (iii) improper, negligent or faulty servicing or repair works done by anyone other than an Electrolux authorised repairer or ASC;
  - (iv) normal wear and tear
  - (v) power surges, electrical storm damage or incorrect power supply;
  - (vi) incomplete or improper installation;
  - (vii) insect, improper or inappropriate operation;
  - (viii) insect or vermin infest
  - (ix) failure to comply with any additional instructions supplied with the Appliance;

In addition, Electrolux is not liable under this warranty if:

- (a) the Appliance has been, or Electrolux reasonably believes that the Appliance has been, used for purposes other than those for which the Appliance was intended, including where the Appliance has been used for any non-domestic purpose;
- (b) the Appliance is modified without authority from Electrolux in writing;
- (c) the Appliance's serial number or warranty seal has been removed or defaced.

**8. How to claim under this warranty:** To enquire about claiming under this warranty, please follow these steps:

- (a) carefully check the operating instructions, user manual and the terms of this warranty;
- (b) have the model and serial number of the Appliance available;
- (c) have the proof of purchase (e.g. an invoice) available;
- (d) telephone the numbers shown below.

**9. Australia:** For Appliances and services provided by Electrolux in Australia: Electrolux goods come with guarantees that cannot be excluded under the Australian Consumer Law. You are entitled to a replacement or refund for a major failure and for compensation for any other reasonably foreseeable loss or damage. You are also entitled to have the Appliance repaired or replaced if the Appliance fails to be of acceptable quality and the failure does not amount to a major failure. 'Acceptable quality' and 'major failure' have the same meaning as referred to in the ACL.

**10. New Zealand:** For Appliances and services provided by Electrolux in New Zealand, the Appliances come with a guarantee by Electrolux pursuant to the provisions of the Consumer Guarantees Act, the Sale of Goods Act and the Fair Trading Act. Where the Appliance was purchased in New Zealand for commercial purposes the Consumer Guarantee Act does not apply.

**11. Confidentiality:** You accept that if you make a warranty claim, Electrolux and its agents including ASC may exchange information in relation to you to enable Electrolux to meet its obligations under this warranty.

**Important Notice**

Before calling for service, please ensure that the steps listed in clause 8 above have been followed.

<p><b>FOR SERVICE</b>                      or to find the address of your nearest authorised service centre in Australia  <b>PLEASE CALL 13 13 49</b>                      For the cost of a local call (Australia only)</p>	<p><b>AUSTRALIA</b>                      ELECTROLUX HOME PRODUCTS                      163 O'Riordan Street, Mascot NSW 2020                      electrolux.com.au</p>	<p><b>FOR SPARE PARTS</b>                      or to find the address of your nearest spare parts centre in Australia  <b>PLEASE CALL 13 13 50</b>                      For the cost of a local call (Australia only)</p>
<p><b>FOR SERVICE</b>                      or to find the address of your nearest authorised service centre in New Zealand  <b>PLEASE CALL 0800 10 66 10</b>                      (New Zealand only)</p>	<p><b>NEW ZEALAND</b>                      ELECTROLUX (NZ) Limited                      3-5 Niall Burgess Road, Mount Wellington                      electrolux.co.nz</p>	<p><b>FOR SPARE PARTS</b>                      or to find the address of your nearest spare parts centre in New Zealand  <b>PLEASE CALL 0800 10 66 20</b>                      (New Zealand only)</p>

Electrolux Home Products Australia  
telephone: 1300363640  
fax: 1800 350 067  
email: [customercare@electrolux.com](mailto:customercare@electrolux.com)  
web: [electrolux.com.au](http://electrolux.com.au)

[shop.electrolux.com.au](http://shop.electrolux.com.au)



Electrolux Home Products New Zealand  
telephone: 0800436245  
fax: 0800 225 088  
email: [customercare@electrolux.co](mailto:customercare@electrolux.co)  
web: [electrolux.co.nz](http://electrolux.co.nz)



To add a touch of professional inspiration to your home, visit [electrolux.com.au](http://electrolux.com.au) or [electrolux.co.nz](http://electrolux.co.nz)

[electrolux.com.au](http://electrolux.com.au)



or [electrolux.co.nz](http://electrolux.co.nz)



P/No.

© 2018 Electrolux Home Products Pty Ltd. ABN 51 004 762 341

EMAN\_Refrigeration\_Factory\_Oct18