

Hisense

life reimagined

USER'S OPERATION MANUAL

Before operating this unit, please read this manual thoroughly, and retain for future reference

HRCD585BW

HRCD585SW

HRCD585BWB

English

Thank you for choosing Hisense. We are sure you will find your new refrigerator a pleasure to use. However, before you use the appliance, we recommend that you carefully read the instructions, which provide details about installing and using the product. Please keep this manual for future reference.

Table of Contents

REFRIGERATOR SAFETY.....	3
PARTS AND FEATURES.....	5
INSTALLATION REQUIREMENTS.....	6
Location Requirements.....	6
Electrical Requirements.....	6
INSTALLATION INSTRUCTIONS.....	7
Unpack the Refrigerator.....	7
Installation Positioning.....	7
Door Removal.....	7
Move Near Water Supply.....	8
Connect the Water Supply.....	9
Complete the Installation.....	10
Level Refrigerator.....	10
Align Doors.....	10
REFRIGERATOR USE.....	11
Opening and Closing Doors.....	11
Using the Controls.....	12
Features.....	14
General Use Information.....	17
REFRIGERATOR CARE.....	19
Cleaning.....	19
Lights.....	19
Vacation and Moving Care.....	20
Reinstalling/Using Refrigerator Again.....	20
TROUBLESHOOTING.....	21

Refrigerator Safety

Your safety and the safety of others are very important.

We have provided many important safety messages in this manual and on your appliance. Always read and obey all safety messages.



This is the safety alert symbol.

This symbol alerts you to potential hazards that can kill or hurt you and others. All safety messages will follow the safety alert symbol and either the word "DANGER," "WARNING" or "CAUTION."

These words mean:



DANGER

An imminently hazardous situation. You could be killed or seriously injured if you don't immediately follow instructions.



WARNING

A potentially hazardous situation which, if not avoided, could result in death or serious bodily injury.



CAUTION

A potentially hazardous situation which, if not avoided, may result in moderate or minor injury.

All safety messages will tell you what the potential hazard is, tell you how to reduce the chance of injury, and tell you what can happen if the instructions are not followed.

Important Safety Instructions

WARNING: To reduce the risk of fire, electrical shock, injury to persons, or damage when using the refrigerator, follow basic precautions, including the following:

- Ensure everyone using this appliance is familiar with its operations and safety features.
- This appliance is not intended for use by persons (including children) with reduced physical, sensory or mental capabilities, unless supervised or properly instructed.
- Children should be supervised to ensure that they do not play with the appliance.
- Plug into a grounded 3 prong outlet.
- Do not remove ground prong.
- Do not use an adapter.
- Do not use an extension cord.
- Do not damage the refrigerant circuit.
- When positioning the appliance, ensure the supply cord is not trapped or damaged.
- Do not locate multiple portable socket-outlets or portable power supplies at the rear of the appliance.
- If the power supply cord is

damaged, it must be replaced by the manufacturer, its service agent or a similarly qualified person to avoid a hazard.

- Disconnect power before servicing.
- Do not use electrical appliances inside the food storage compartments of the refrigerator, unless they are of the type recommended by the manufacturer.
- Replace all parts and panels before operating.
-  **CAUTION:** Risk of fire or flammable materials
- Flammable refrigerant used. To be repaired only by trained service personnel. Do not puncture refrigerant tubing.
- Flammable refrigerant used. Dispose of properly in accordance with federal or local regulations.
- Flammable refrigerant used. Follow handling instructions carefully. Risk of fire or explosion due to puncture of refrigerant tubing.
- It is hazardous for anyone other than an Authorized

Service Person to service this appliance. In Queensland the Authorized Service Person MUST hold a Gas Work Authorization for hydrocarbon refrigerants to carry out servicing or repairs which involve removal of covers.

- Use nonflammable cleaner.
- Do not use mechanical devices or other means to accelerate the defrosting process, other than those recommended by the manufacturer.
- Keep flammable materials and vapors, such as gasoline, away from refrigerator.
- **CAUTION:** Do not store products which contain flammable propellants (e.g. spray cans) or explosive substances in the refrigerator.
- Keep ventilation openings in the appliance enclosure or in the built-in structure clear of obstruction.
- Connect to potable water supply only.
- Use two or more people to move and install refrigerator.
- To avoid the risk of children becoming trapped and suffocating, do not allow them to play or hide inside the refrigerator.

Read and Save These Instructions

Proper Disposal of Your Old Refrigerator

WARNING

Suffocation Hazard

Remove doors from your old refrigerator.
Failure to do so can result in death or brain damage.

IMPORTANT: Child entrapment and suffocation are not problems of the past. Junked or abandoned refrigerators are still dangerous- even if they will sit for "just a few days." If you are getting rid of your old refrigerator, please follow these instructions to help prevent accidents.

Before You Throw Away Your Old Refrigerator or Freezer:

- Take off the doors.
- Leave the shelves in place so that children may not easily climb inside.

Important information to know about disposal of refrigerants:

Dispose of refrigerator in accordance with Federal and Local regulations. Refrigerants must be evacuated by a licensed, EPA certified refrigerant technician in accordance with established procedures.

Parts and Features

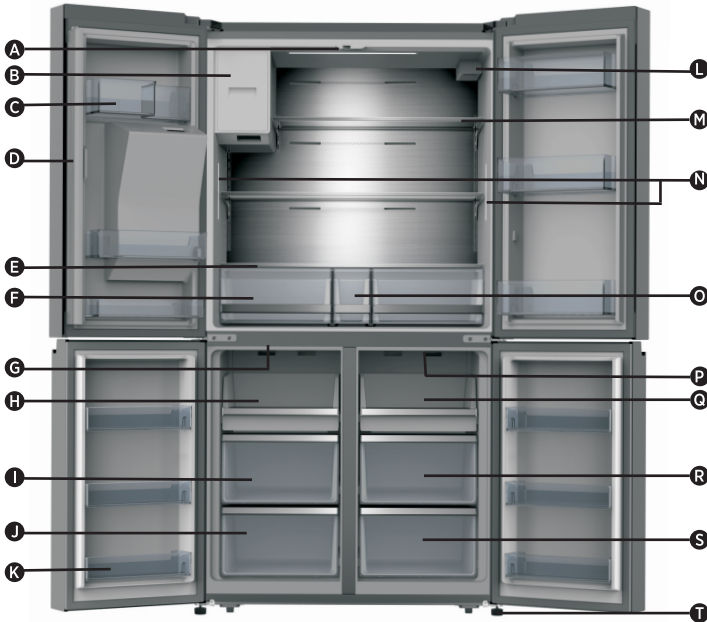

- | | | |
|---------------------------------|-----------------------------------|--|
| A Refrigerator LED Light | H Freezer Tray | O Middle Storage Drawer |
| B Ice-Maker | I Freezer Middle Drawer | P Convertible Compartment LED light |
| C Refrigerator Door Bin | J Freezer Lower Drawer | Q Convertible Compartment Tray |
| D Rotary Separator | K Freezer Door Bin | R Convertible Compartment Middle Drawer |
| E Cover | L Water Filter | S Convertible Compartment Lower Drawer |
| F Storage Drawer | M Glass Shelf | T Leveling Leg |
| G Freezer LED Light | N Refrigerator side lights | |

NOTE: Your model may look different from this and other images in this manual, depending on your model's features.

NOTE: To get the best energy efficiency of this product, please place all shelves, drawers on their original position as the illustration above.

Installation Requirements

Location Requirements

WARNING



Risk of fire/ flammable materials

Keep flammable materials and vapors, such as gasoline, away from appliance.
Failure to do so can result in death, explosion or fire.

IMPORTANT: This refrigerator is designed for indoor, household use only.

Temperature

This refrigerator is intended for use in a location where the temperature ranges from a minimum of 16°C to a maximum of 43°C. The preferred room temperature range for optimum performance, which reduces electricity usage and provides superior cooling, is between 16°C and 32°C. It is recommended that you do not install the refrigerator near a heat source, such as an oven or radiator.

Exterior and Dimensions

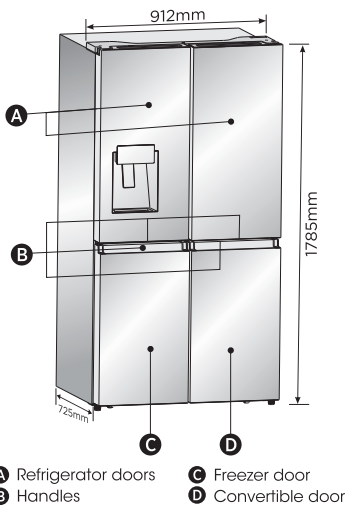

Ventilation

Adequate air circulation around the refrigerator is required for efficient operation.

To ensure proper ventilation, maintain the recommended clearances.

Recommended Clearances

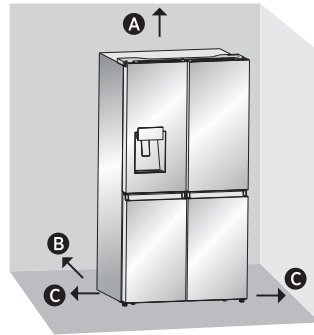

- A** 100mm Above
- B** 50mm Behind
- C** 50mm Each Side

NOTE: If you place the refrigerator next to a fixed wall, leave 1471.4mm minimum space to allow the door to swing open.

Electrical Requirements

WARNING



Electrical Shock Hazard

Plug into a grounded 3 prong outlet.
Do not remove the ground prong from the power cord plug.
Do not use an adapter.
Do not use an extension cord.
Failure to do so can result in death, fire or electrical shock.

Before you move your refrigerator into its final location, it is important to make sure you have the proper electrical connection.

Recommended Grounding Method

AC 220-240 volt, 50 Hz, AC only 15- or 20-amp fused, grounded electrical supply is required. It is recommended that a separate circuit serving only your refrigerator is provided. Use an outlet that cannot be turned off by a switch. Do not use an extension cord.

NOTE: Before performing any type of installation or cleaning, disconnect the refrigerator from the electrical source. When you have finished, reconnect the refrigerator to the electrical source and reset the temperature controls to the desired setting.

Installation Instructions

Unpack the Refrigerator

WARNING



Fire or Explosion Hazard

- Do not puncture refrigerant tubing.
- Follow handling instructions carefully.
- Flammable refrigerant used.
- Failure to do so can result in death, explosion or fire.

IMPORTANT: Handle with care when moving refrigerator to avoid either damaging the refrigerant tubing or increasing the risk of a leak.

WARNING

Excessive Weight Hazard

- Use two or more people to move and install refrigerator.
- Failure to do so can result in back or other injury.

Remove the Packaging

- Remove tape and glue residue from surfaces before turning on the refrigerator. Rub a small amount of liquid dish soap over the adhesive with your fingers. Wipe with warm water and dry.

NOTE: Do not use sharp instruments, rubbing alcohol, flammable fluids, or abrasive cleaners to remove tape or glue. These products can damage the surface of your refrigerator. For more information, see "Refrigerator Safety."

- Dispose of/recycle all packaging materials.
- If the refrigerator has been placed in a horizontal or tilted position for any period of time, wait 4 hours before plugging it in to allow the oil to settle into the compressor.

When Moving Your Refrigerator:

Your refrigerator is heavy. When moving the refrigerator for cleaning or service, be sure to cover the floor with cardboard or hardboard to avoid floor damage. Always pull the refrigerator straight out when moving it. Do not wiggle or "walk" the refrigerator when trying to move it, as floor damage could occur.

Clean Before Using

After you remove all of the packaging materials, clean the inside of the refrigerator before using it. See the cleaning instructions in "Refrigerator Care."

Important information to know about glass shelves and covers:

Do not clean glass shelves or covers with warm water when they are cold. Shelves and covers may break if exposed to sudden temperature changes or impact, such as bumping. Tempered glass is designed to shatter into many small, pebble-size pieces. This is normal. Glass shelves and covers are heavy. Use both hands when removing them to avoid dropping.

Installation Positioning

- This application perform well from SN to ST. The Appliance may not work properly if it is left for a longer period at a temperature above or below the indicated range.

Climate class	Ambient temperature
SN	+10°C to +32°C
N	+16°C to +32°C
ST	+16°C to +38°C
T	+16°C to +43°C

Door Removal (only if needed)

Measure the refrigerator to make sure it will fit through the doorway. If the refrigerator cannot pass easily through the doorway, follow the instructions to remove the two refrigerator compartment doors and the front panel of the freezer drawer.



WARNING



Electrical Shock Hazard

- Disconnect power before removing doors.
- Reconnect ground wire before operating.
- Failure to do so could result in death or electric shock.

Tools you will need (Not provided)

	
Allen Wrench (4mm)	Wrench (8mm)
	
Phillips Screwdriver	

Remove the Doors

IMPORTANT: Keep the refrigerator doors closed until you are ready to lift them from the cabinet.

1. Unplug refrigerator or disconnect power.
2. Using a Phillips screwdriver, remove the three screws attaching the hinge cover, and then remove the hinge cover with the entire harnesses attached.

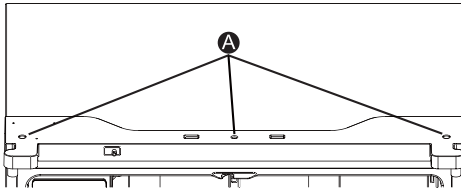

A Screws

3. Separate the two connectors on the left side door. To remove the wire connector, press the top of the connector (B) and separate it from the other one. To remove the water coupler from the hinge, twist and pull the clips from the coupler. Remove the water line (C) while pressing the movable part (D) of the water line coupler.

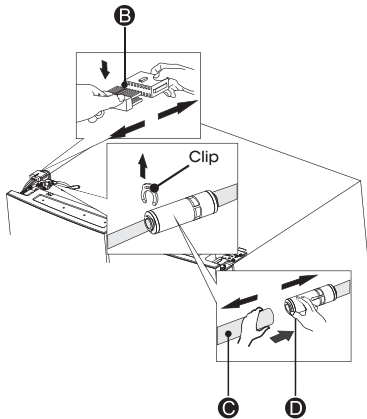

4. Remove the 3 screws (E) fixed on the hinges, with a Wrench (8mm) and 1 ground screws (F) attached to the hinge with Philips (+) screwdriver. Remove the upper left door hinge (G).

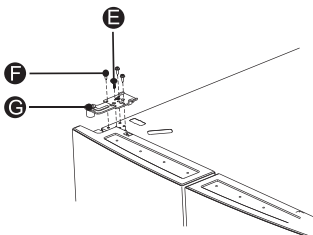

5. Use your both hands to open the door more than 90°. Lift it up and take it off.

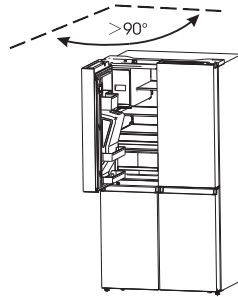

6. If necessary, remove the 2 hex head bolts hinges (I) with an Allen wrench (5 mm). Remove the lower left door hinge (H).

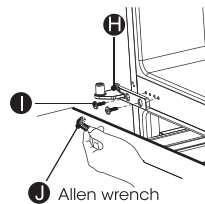

Replace the Doors

1. If removed, reinstall the bottom hinge.
2. Using two or more people, set the refrigerator door onto the bottom hinge.
3. Insert the top hinge into the top of the door.
4. Using the three screws removed earlier, fasten the top hinge to the top of the cabinet.
NOTE: Left-hand door only, replace the ground screw into the top hinge, reattach the wire harness, reconnect the water line, make sure the clips are properly connected to the coupler.
5. Repeat steps 1 through 4 to replace the opposite door.
6. Using the three screws removed earlier, reinstall the top hinge cover and control panel to the top of the cabinet.

Move Near Water Supply

⚠ WARNING



Fire or Explosion Hazard

- Do not puncture refrigerant tubing.
- Follow handling instructions carefully.
- Flammable refrigerant used.
- Failure to do so can result in death, explosion or fire.

IMPORTANT: The refrigerator must be located on a solid, level surface that is strong enough to support the refrigerator fully loaded.

- Before moving, retract the leveling legs to avoid scraping the floor.
- The refrigerator has wheels, which should be used for only forward and backward movement.

NOTE: Trying to move the refrigerator sideways may damage your floor.







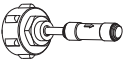

Connect the Water Supply

A water dispenser with a filter is one of the helpful features on your new appliance. To help promote better health, the water filter removes unwanted particles from your water. However, it does not sterilize or destroy microorganisms. You may need to purchase a water purifying system to do that. In order for the ice maker to operate properly, a water pressure of 30-125psi is required. Under normal conditions, a 200cc (5.75 oz.) cup can be filled in about 10 seconds.

If the refrigerator is installed in an area with low water pressure (below 30 psi), you can install a booster pump to compensate for the low pressure. After you have connected the water line, make sure the water storage tank inside the refrigerator is properly filled. To do this, press the water dispenser lever until the water runs from the water outlet.

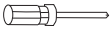
Parts for water line installation

The tools you will need:

			
Connector and check valve	Valve Seat	Clip	Screw
			
Phillips screwdriver	Water line (5m)	Two-Way Connector	Spanner

Connecting to the water supply line

The connector and the check valve are provided as one part. You should use the new connector incidentally but not the old one you have. First, turn off the main water supply line. Screw the adaptor onto a suitable 3/4" BSP connector water outlet and use the spanner to tighten it. Fully insert the water line into the check valve. Then insert the clip in the install pack as the figure shown below.

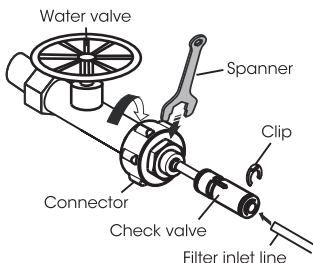

To prevent the clips loose, use the valve seat to hold it. Then use the screw to hold the valve seat with Philips(+) screwdriver.

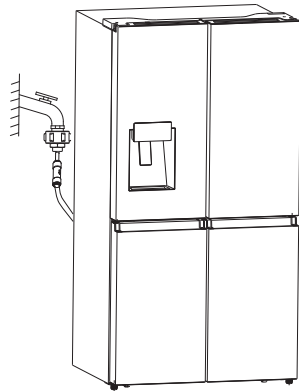
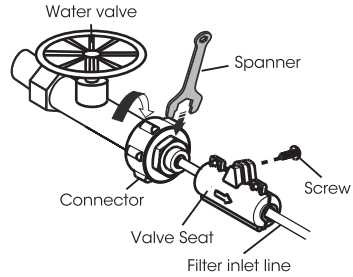

NOTE:

- After connected to the water supply line, please open the water valve to flush the filter for 5 minutes before use.
- If the main supply line is too far away from the refrigerator to be connected to the filter inlet line, the water line(5m) provided may be helpful. The outlet line of the water filter should be connected with the inlet line of the refrigerator by a Two-Way Connector. The water line must be fully inserted into the center of the connector to prevent water leaking. Insert the 2 clips in the installation pack as shown in the diagram, and then confirm that each clip holds the line firmly.

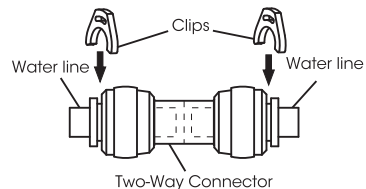

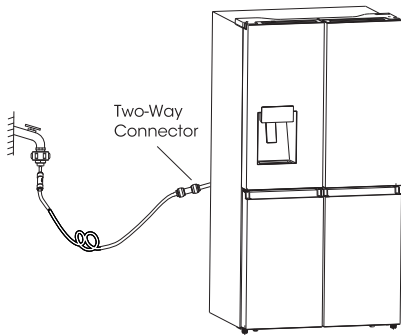

- The initial dark discoloration of water is normal.
- The water lines must be connected with the potable water only.
- The water lines should not be pressed by heavy things and should not bend too much.
- It is normal that there will be sound of exhaust coming out from the appliance when you connect the water line to the appliance and press the level of the dispenser for the first time.

Warning:

- After turning on the water valve, make sure that there is no leakage at all connection points of the water lines. If there is a leakage, turn off the valve immediately and tighten the water connector or make the lines fully inserted into the connector.
- The water line must be connected to the cold water pipe. If it is connected to the hot water pipe, it may cause the purifier to malfunction.

Complete the Installation

! WARNING



Electrical Shock Hazard

Plug into a grounded 3 prong outlet.
 Do not remove the ground prong from the power cord plug.
 Do not use an adapter.
 Do not use an extension cord.
 Failure to do so can result in death, fire or electrical shock.

1. Plug into a grounded 3 prong outlet.

NOTE: This refrigerator begins operating as soon as it is connected to the power supply.

2. Move the refrigerator into its final location, making sure to maintain the recommended clearance.

Level Refrigerator if needed

The refrigerator must be level to maintain optimal performance and appearance.

1. Turn the leveling feet on the bottom, front of the cabinet to raise or lower that side of the refrigerator until the refrigerator is level side to-side.
2. Turn both feet by the same amount, to slightly raise the front of the refrigerator. This will make it easier for the doors to close.

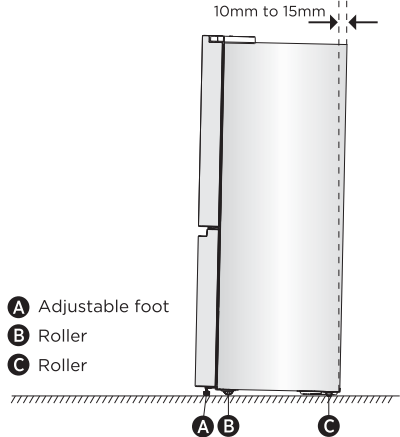

NOTE: Having someone push against the top of the refrigerator takes some weight off the leveling feet. This makes it easier to turn the feet. Rotate the adjustable feet clockwise to raise or counter-clockwise to lower your refrigerator. To make sure that the doors close automatically, tilt the top of your refrigerator backward about 10mm to 15mm. If necessary, use a spanner wrench to adjust the feet.

Align Doors (if needed)

The gaskets are used to align doors, you can find them in the manual bag.

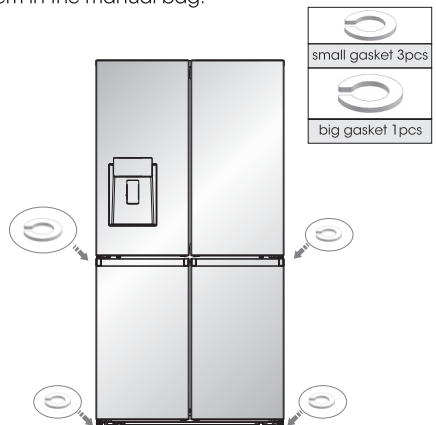

Refrigerator Use

Opening and Closing Doors

Providing room for doors to open

Make sure that you have enough room in front of your refrigerator to swing the doors open.

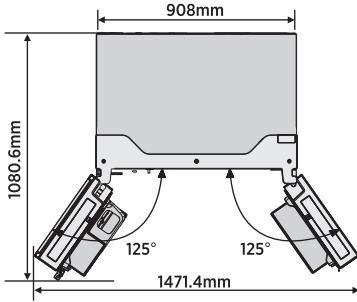

The four doors can be opened and closed either separately or together.

- There is a mullion on the left-hand side refrigerator compartment door.
- When closing the left-hand door, the mullion folds behind the right-hand door joining the two doors.
- The temperature of the door frame is controlled

to help prevent moisture from developing on the mullion. The temperature of the surface may be warm, which is normal, and will not affect the performance of the refrigerator.

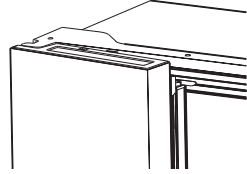

NOTE: Before closing the left-hand door, make sure the mullion is folded inward. If the mullion is pulled outward it may become damaged when you try to close the door.

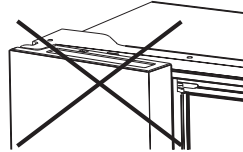

Using the Controls

Your product has one control panel which is on the fridge door. Use your appliance according to the following control guidelines.

Control Panel

The control panel is shown in the diagram below.

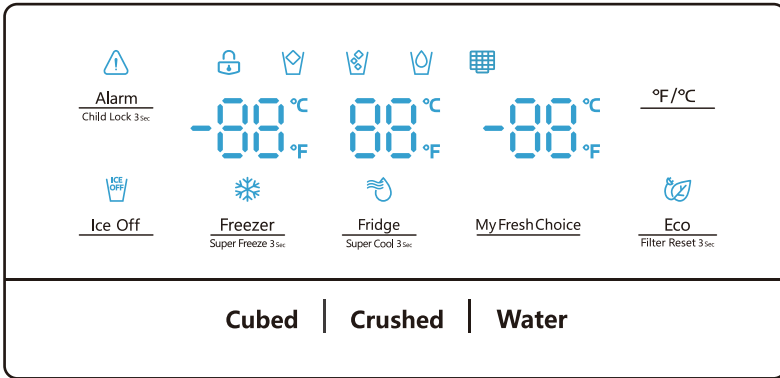

The display will illuminate when the refrigerator is first plugged in. However, the lights will automatically turn off after 60 seconds.



Child Lock and Door Alarm Alarm Child Lock 3 sec

This button serves two purposes:

1. Child Lock

Press and hold "Alarm" for 3 seconds to lock the whole Control Panel including dispenser function. If Control panel is locked, the icon  will be on, and none of the buttons on the Control panel work. To unlock the Control panel, please press and hold "Alarm" for 3 seconds again.

2. Door Alarm

Leaving any door open for over 2 minutes will activate door alarm. The  icon will flicker, the control panel will display "dr", and you will hear a buzzer sound. The buzzer will sound 3 times per minute and will stop after 8 minutes. In case of alarm, you can touch the Alarm button to cancel door alarm, then the  icon stops flickering and keeps on, the buzzer sound will stop at the same time. Also door alarm can be stopped by closing all the doors.

To save energy, please avoid keeping doors open for a long time when using refrigerator.

Ice Off Ice Off

You can touch "Ice Off" button to control the ice maker. When the Child Lock is off, you can touch the "Ice Off" icon to lock the ice maker, and the icon  will be illuminated. If you want to unlock the ice maker, please touch the "Ice Off" icon

again, and the icon  will be off.

NOTE: When the "Ice Off" is on, it only locks the ice maker not the dispenser.

Fridge Temperature Control Fridge Super Cool 3 sec

When you touch the button continuously, the temperature will be set in the following sequence.

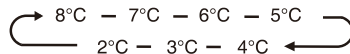

If you want to decrease the time needed to cool items in the Fridge, please touch and hold this button for 3 seconds, the Super Cool icon  will be illuminated, the fridge temperature setting will display 2°C. Super Cool automatically switches off after 3 hours, and the refrigerator temperature setting will revert back to the previous setting. When Super Cool function is on, you can touch the "Fridge" to switch it off.

NOTE:

On the Super Cool Function, when you touch the "Eco" button, Eco function will be activated, and "Super Cool" mode will be off.

Freezer Temperature Control Freezer Super Freeze 3 sec

You can touch the "Freezer" button to activate the mode to control the freezer temperature. When you press the button continuously, the temperature will be set in the following sequence.

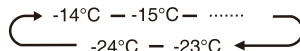

Press and hold the button for 3 seconds, the icon

"❄️" will be illuminated, the freezer temperature setting will display -24°C.

Super Freeze can quickly lower the temperature and freeze your food faster than usual. This can retain more of the vitamins and nutrition in fresh food and keep your food longer.

Super Freeze automatically switches off after 52 hours, and the freezer temperature setting will revert back to the previous setting.

When the Super Freeze function is on, you can touch "Freezer" to switch off the Super Freeze function.

The Super Freeze is used to perform pre-freezing and fast freezing in sequence of Freezer compartment. This function accelerates the freezing of fresh food and, at the same time, protects foodstuffs already stored from undesirable warming.

 To freeze fresh food, activate the Super Freeze function at least 24 hours before placing the food to complete pre-freezing.

NOTE:

On the Super Freezer Function, when you touch the "Eco" button, Eco function will be activated, and "Super Freezer" mode will be off.



My Fresh Choice **My Fresh Choice Temperature Control**

You can touch the "My Fresh Choice" button to activate the mode to control the convertible compartment temperature.

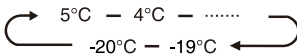
When you press the button continuously, the temperature will be set in the following sequence.



Dispense Control

When the Child Lock is on, the dispenser will not work. When the Child Lock is off, you can press the "Cubed" or "Crushed" option to choose the type of ice to be dispensed, and press the "Water" button will activate the water mode. If you choose the function of Cubed, the  icon will be illuminated, choose the function of Crushed the  icon will be illuminated, and the  icon will be illuminated when Water function is chosen.

°F/°C

In the unlocked state, press °F/°C button to switch between Celsius and Fahrenheit units. The default state is Celsius display.



Energy Save



Filter Reset 3 sec

You can touch this button to turn Energy Save mode on and off. When you turn Energy Save on, the Eco icon  lights.

The temperature of the fridge is automatically switched to 6°C and the freezer to -17°C.

If Energy Save is off, the icon  will go off and the temperature setting will revert back to the previous setting.

Water Filter

The state of the water filter is calculated by the main control board and transmitted to the display panel. The first time the power is switched on and the water enters the filter, the filter state is calculated at 99%. When the water filter state drops to 15%, the icon  is lit. When the filter state reaches 10%, the icon  will flash. The user needs to replace the filter and long press the Energy Save Button for 3 seconds to reset the water filter state. The filter state will then be re-calculated to 99%.

Demo mode

Demo mode is for store display, and it prevents the refrigerator from generating cool air. In this Cooling off Mode, the refrigerator may seem like it is working but it will not make cool air.

The indicators on the control panel will show "OFF". To cancel this mode, press and hold "Alarm" and "°F/°C" keys at the same time for 3 seconds and the buzzer will make a long sound.

Features

This section tells you how to use most of the useful features. We recommend that you read through them carefully before using the appliance.

Important information to know about glass shelves and covers:

Do not clean glass shelves or covers with warm water when they are cold. Shelves and covers may break if exposed to sudden temperature changes or impact, such as bumping. Tempered glass is designed to shatter into many small, pebble-size pieces. This is normal. Glass shelves and covers are heavy. Use both hands when removing them to avoid dropping.

1. Refrigerator

IMPORTANT: To avoid damage to the doors, make sure all shelves and drawers are pushed fully into the cabinet before closing a door.

Adjustable Shelves

The height of the shelves can be adjusted to fit your storage needs.

1. To remove a shelf, gently lift upward and then pull the shelf forward until the end of the shelf passes the rail support.

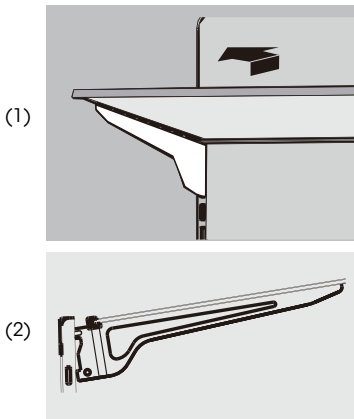

2. To reinstall a shelf, gently slide the shelf back into the refrigerator compartment, and lower the shelf onto the rail support.

2. Removable door bins

The bins located in the middle of the door are adjustable.

To Remove and Replace a Door Bin:

1. Place hands on both sides of the bin and lift upward.

2. Pull the door bin out.

3. Replace the door bin by inserting it above the support and pressing down to snap into place.

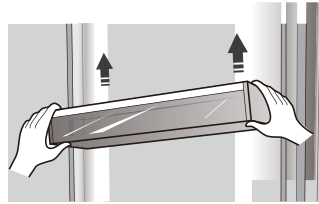

3. Removing/Replacing freezer drawer

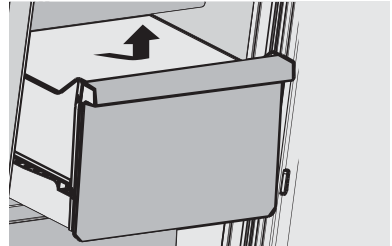

To Remove/Replace Freezer Drawer:

1. Pull out drawer to maximum extension.
2. Lift up to remove the drawer.
3. Reverse steps 1 and 2 to replace the drawer.

4. Getting cold water and ice

Push the appropriate ice or water type button to select what you want to dispense.

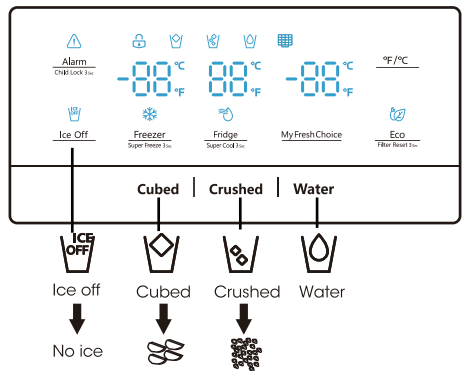

NOTE: The quality of your ice will be only as good as the quality of the water supplied to your ice maker. Avoid connecting the ice maker to a softened water supply. Water softener chemicals (such as salt) can damage parts of the ice maker and lead to poor quality ice. If a softened water supply cannot be avoided, make sure the water softener is operating properly and is well-maintained.

Getting cold water

The water dispenser is located in the fridge door. To get water, push the water button. Then move your glass down to the dispenser lever (A) in the suggested position and press it.

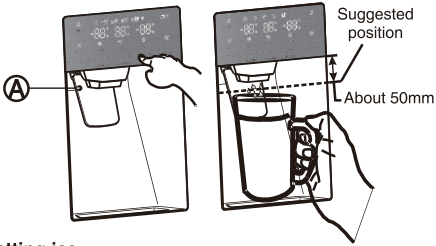

Getting ice

To get ice, push the cubed or crushed ice button as required. Then move your glass down to the dispenser lever in the suggested position and press it.

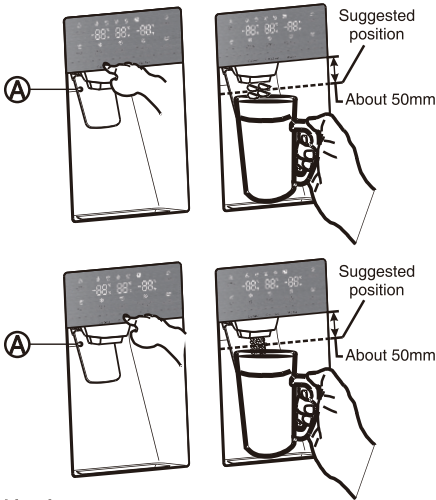

Making ice

To fill the ice bucket to maximum capacity after installation, follow these steps:

1. Allow your refrigerator to operate and cool down for 24 hours (or 1 full day). Waiting 24 hours will allow your ice maker to cool properly.
2. Dispense 4 to 6 ice cubes into the glass.
3. After 8, and then 16 hours, dispense a full glass of ice.

Warning:

Do not put food in the ice bucket. If you store food in the ice bucket, the food can strike the ice maker when you open or close the door, causing damage to the ice maker.

Note that the ice cubes in the ice bucket may spill out over the drawer. If this occurs, be sure to clear the ice cubes that spilled out of the drawer.

•If a power failure occurs, ice cubes may melt, and then freeze together when the power comes back

on, causing the dispenser to stop working.

•To prevent this problem, after a power failure, pull out the ice bucket and residual ice or water.

Note:

•Don't push the water dispenser lever forward without a cup below since it may cause water spilling.

•To avoid cold air leaking out from cabinet, keep the water dispenser still installed even if the dispenser is not in use.

Using the ice off function

When you select the ice off mode, remove all ice cubes from the bucket.

If you leave the ice cubes in the bucket, the ice cubes may clump together, making it difficult to remove them.

First, open the door at the maximum Angle.

Then, lift up on the ice bucket, and pull it straight out in the direction of the arrow.

To put the ice bucket in, push it firmly straight back. If the bucket does not fit, turn the helix 90 degree (see the the last illustration on the right, below) and try again.

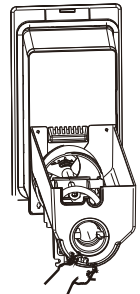
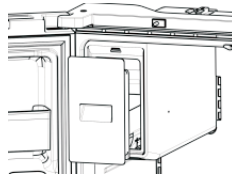
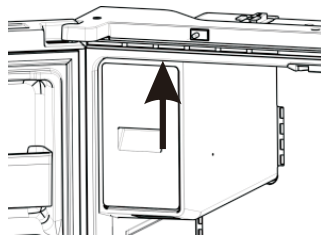
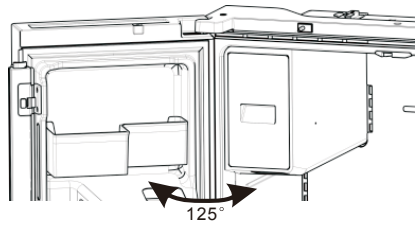

NOTE:

- The inside of the ice bucket is very cold when the refrigerator is operating. Don't reach deep inside the ice bucket.
- Use only the ice maker provided with the refrigerator. The water supply to this refrigerator must only be installed by a qualified person.
- To operate the ice maker properly, water pressure of 30~125 psi is required.
- When the user disconnects the refrigerator, the ice from the ice box needs to be removed.

Going on vacation

If you have a long vacation or business trip and won't use the water or ice dispensers for a long time:

1. Close the water valve. Otherwise, water leakage may occur.
2. Remove all food.
3. Unplug the refrigerator.
4. Wipe excess moisture from inside and leave the doors open. Otherwise, odor and mold may develop.

Warning:

- Do not put your fingers, hands or any other unsuitable objects in the chute or ice-maker bucket. It may result in personal injury or material damage.
- Never put your fingers or any other objects in the dispenser opening. It may cause injury.
- Do not try to disassemble the ice maker.
- Do not wash or spray the ice bucket with water while it is in the refrigerator. Remove it to clean.

Water clouding phenomenon

All water provided to the refrigerator flows through the filter which is an alkaline water filter. In the filtering process, the pressure of the water that has flowed out of the filter is increased, and the water becomes saturated with oxygen and nitrogen. When this water flows out into the air, the pressure plummets and the oxygen and nitrogen get supersaturated, which results in gas bubbles. The water may temporarily look misty or cloudy due to these oxygen bubbles. After a few seconds, the water will look clear.

Cleaning

After using for a period, water accumulated in receiving tank might overflow, thus you should clean it with dry towel regularly to avoid water spilling out onto the floor.



Receiving tank

NOTE:

In case of stained by dust or other pollutant, dispensing water with unpleasant smell, etc.,

water dispenser parts should be cleaned thoroughly.

5. Changing the water filter

Caution

Please refer to this user's manual for proper maintenance and operation. If this device is not maintained and operated as specified in the owner's manual, there is a risk of exposure to contaminants.

To drink the freshest and cleanest water from your refrigerator, change the filter on time.

To change the water filter, follow these steps:

1. Shut off the water supply. Then pull the handle under the cover outwards to open the cover.

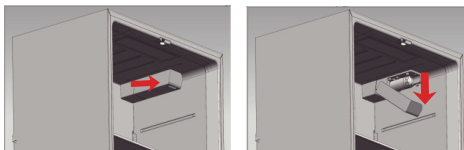

2. Pull the water filter down wards and turn it about 90° counter-clockwise to take it out. When the filter is disassembled, pay attention to keep the filter head upward tilted to avoid water leaking from the front filter part. And the dropped water in the cover should be cleaned immediately.

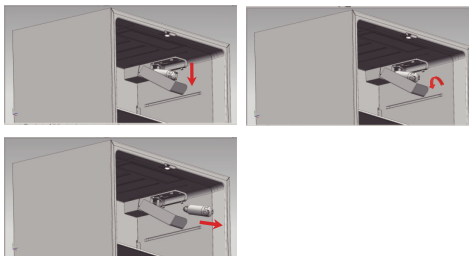

3. Insert the new water filter into the hole, and at the same time turn it about 90° clockwise until it stops.

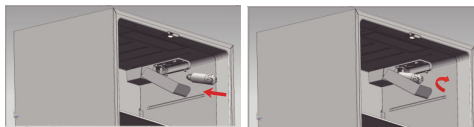

4. Push the water filter up, and move the cover up to horizontal and push it until it locks.





5. Turn the water supply back on.

NOTE: After turning on the water supply, you should check the leaks. If leaks occur, repeat the above operation steps 1-5. If leaks persist, please stop using it and call your supporting dealers.

6. Flush filter for 5 minutes before use.

Removing any residual matter inside the water supply line after installing the water filter

1. Turn on the main water supply and supply water from water supply line.

2. Let the water flow through the dispenser until it becomes clear (after approx. 6 to 7 minutes). This will clean the water supply system and remove the air from the lines.

3. Additional flushing may be required in some households.

4. Open the refrigerator door and make sure there are no water leaks coming from the water filter.

Note:

- Be sure to flush the dispenser thoroughly, otherwise water may drip from the dispenser. This means that there is still air in the line.

Reverse osmosis water supply is important:

The pressure of the water supply coming out of a reverse osmosis system going to the water inlet valve of the refrigerator needs to be between 30 and 125 psi (207 and 862 kpa). If a reverse osmosis water system is connected to your cold water supply, the water pressure to the reverse osmosis system needs to be a minimum of 40 to 60 psi (276 to 414 kpa). If the water pressure to the reverse osmosis system is less than 40 to 60 psi (276 to 414 kpa):

- Check to see whether the sediment filter in the reverse osmosis system is blocked. Replace the filter if necessary.
- Allow the storage tank on the reverse osmosis system to refill after heavy usage.
- If your refrigerator has a water filter, it may further reduce the water pressure when used in conjunction with a reverse osmosis system. Remove the water filter.

6. Using your fridge compartment

The refrigerator compartment is suitable for storage of vegetables and fruit. Food inside should be packed to store in order to avoid losing moisture or flavor permeating into other foods.

Caution

Never close the refrigerator door while the shelves, crisper and/or telescopic slides are extended. It may damage both them and the refrigerator.

Door baskets

The refrigerator compartment is provided with several different door baskets, which are suitable for the storage of canned liquid, bottled drinks and packed food.

To remove the door baskets (A), simply lift the racks up and pull straight out.

To relocate the door baskets (A), slide them in above the desired location and push down until they stop.

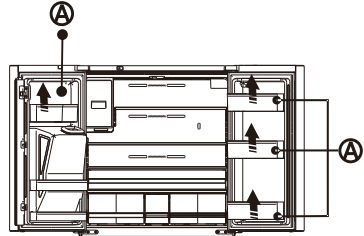

To remove the door baskets (B), take the right side of the baskets out by lifting it at an angle along the guide, and then take the left side out by pulling it from the door.

To relocate the door baskets (B), slide them into the original location and push down until they stick.

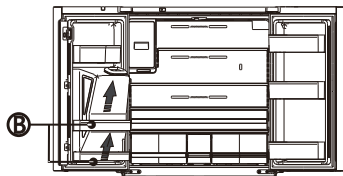

Warning:

Do not place too many heavy things in the baskets. Before you lift up the door shelf vertically, please take the food out.

Glass shelves

To remove the glass shelves, tilt up the front of the shelf shown in Page14 (1) and lift it up vertically shown in Page14 (2). Then pull the shelf out.

General Use Information

- When first turning on refrigerator after a period of non-use, allow the refrigerator to cool at least 2 hours before adding food.
- Do not block air circulation vents with stored

items.

- Store items so that the air can circulate freely around them.
 - Cover or wrap stored food well to avoid transfer of odors.
 - Once defrosted, food quality will deteriorate rapidly. Defrosted food should not be refrozen.
 - Neither bottled nor canned drinks should be stored in the freezer compartment. Bottles and cans may explode.
- To avoid contamination of food, please respect the following instructions:
- Opening the door for long periods can cause

a significant increase of the temperature in the compartments of the appliance.

- Clean regularly the surfaces that can come in contact with food and accessible drainage systems.
- Store raw meat and fish in suitable containers in the refrigerator, so that it is not in contact with or drip onto other food.
- Two-star frozen-food compartments are suitable for storing pre-frozen food, storing or making ice-cream and making ice cubes.
- Two-star compartments are not suitable for the freezing of fresh food.

Order	Compartments Type	Target storage temp.[°C]	Appropriate food
1	Fridge	+2-+8	Eggs, cooked food, packaged food, fruits and vegetables, dairy products, cakes, drinks and other foods which are not suitable for freezing.
2	(***)*-Freezer	≤ -18	Seafood (fish, shrimp, shellfish), freshwater aquatic products and meat products (recommended for 3 months ,the longer the storage time, the worse the taste and nutrition),suitable for frozen fresh food.
3	***-Freezer	≤ -18	Seafood (fish, shrimp, shellfish),freshwater aquatic products and meat products (recommended for 3 months, the longer the storage time, the worse the taste and nutrition),are not suitable for frozen fresh food.
4	** -Freezer	≤ -12	Seafood (fish, shrimp, shellfish), freshwater aquatic products and meat products (recommended for 2 months, the longer the storage time, the worse the taste and nutrition), are not suitable for frozen fresh. food.
5	*-Freezer	≤ -6	Seafood (fish, shrimp, shellfish), freshwater aquatic products and meat products (recommended for 1 month, the longer the storage time, the worse the taste and nutrition) are not suitable for frozen fresh food.
6	0-star	-6-0	Fresh pork, beef, fish, chicken, some packaged processed foods, etc. (Recommended to eat within the same day, preferably no later than 3 days) . Partially encapsulated processed foods (non-freezable foods)
7	Chill	-2- +3	Fresh/frozen pork, beef, chicken, freshwater aquatic products, etc.(7 days below 0°C and above 0°C is recommended for consumption within that day, preferably no more than 2 days). Seafood (less than 0°C for 15 days, it is not recommended to store above 0°C)
8	Fresh Food	0- +4	Fresh pork, beef, fish, chicken, cooked food, etc. (Recommended to eat within the same day, preferably no more than 3 days)
9	Wine	+5- +20	Red wine, white wine, sparkling wine etc.

NOTE: please store different foods according to the compartments or target storage temperature of your purchased products.
If the refrigerating appliance is left empty for long periods, switch off, defrost, clean, dry, and leave the

door open to prevent mould developing within the appliance.
Make sure the compliance is checked by regular inspections.

Refrigerator Care

Cleaning

Both the refrigerator and freezer sections defrost automatically. However, clean both sections about once a month to avoid buildup of odors. Wipe up spills immediately. To avoid odor transfer and drying out of food, wrap or cover foods tightly.

WARNING



Explosion Hazard

Use nonflammable cleaner.

Failure to do so can result in death, explosion or fire.

IMPORTANT:

- Do not use harsh chemicals, ammonia, chlorine bleach, concentrated detergent, solvents, abrasives or metal scouring pads to clean your refrigerator inside or out. They can damage and/or discolor the refrigerator finish.
- Do not use warm water to clean glass shelves while they are still cold. Glass may break when exposed to sudden temperature changes.

Shelf parts clean

- When cleaning the shelf parts, remove the lower shelf parts and place them horizontally. Either front or back, to prevent the shelf support from falling off.
- If the shelf parts are placed at an angle, their sides will touch the ground. When the force applied for cleaning is not proper, the shelf bracket will easily fall off.

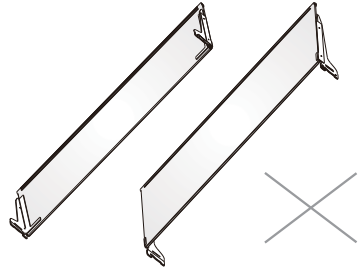

WARNING



Electrical Shock Hazard

Unplug your appliance or disconnect power before cleaning.

Failure to do so can result in death, electric shock or personal injury.

1. Unplug refrigerator or disconnect power.
2. Clean the interior.

Hand wash, rinse, and dry removable parts and interior surfaces thoroughly. Use a clean sponge or soft cloth and a mild detergent in warm water.

3. Clean the door seals (gaskets). A dirty or sticky door seal may adhere to the cabinet and tear when you open the door.

Using a soft cloth and a solution of mild detergent and warm water, hand wash the door seals. Rinse with clear water and dry thoroughly.

4. Clean the exterior surfaces.

Wash exterior surfaces with a clean, soft cloth or sponge and a mild detergent in warm water. Rinse surfaces with clean, warm water and dry immediately to avoid water spots.

5. Plug in refrigerator or reconnect power.

Lights

IMPORTANT: Your refrigerator is equipped with LED lighting. These lights are designed to last for the life of your refrigerator. However, if the lights stop operating, please contact a qualified technician for replacement.

Vacation and Moving Care

Vacation

If You Choose to Leave the Refrigerator On While You're Away:

1. Use up any perishables and freeze other items.

If You Choose to Turn Off the Refrigerator Before You Leave:

1. Remove all food from the refrigerator and freezer.
2. Unplug refrigerator or disconnect power.
3. Clean refrigerator, wipe it, and dry well.
4. Tape rubber or wooden blocks to the tops of the two doors, and let them open a sufficient distance to let air in. This stops odor and mold from building up.

Moving

WARNING



Fire or Explosion Hazard

Do not puncture refrigerant tubing.
Follow handling instructions carefully.
Flammable refrigerant used.
Failure to do so can result in death, explosion or fire.

IMPORTANT: Handle with care when moving refrigerator to avoid either damaging the refrigerant tubing or increasing the risk of a leak.

WARNING

Excessive Weight Hazard

Use two or more people to move and install refrigerator.
Failure to do so can result in back or other injury

When you are moving your refrigerator to a new home, follow these steps to prepare it for the move.

1. Remove all food from the refrigerator and pack all frozen food in dry ice.
2. Unplug refrigerator.
3. Clean, wipe, and dry thoroughly.
4. Take out all removable parts, wrap them well, and tape them together so they don't shift and rattle during the move.

5. Raise the leveling legs so they don't scrape the floor. See "Level Refrigerator."
6. Seal the doors with tape and tape the power cord to the back of the refrigerator. When you get to your new home, put everything back and refer to the "Installation Instructions" section for preparation instructions.

Reinstalling/Using Refrigerator Again

If the refrigerator has been placed in a horizontal or tilted position for any period of time, wait 4 hours before plugging it in to allow the oil to settle into the compressor.

1. Clean refrigerator. See "Cleaning."
2. Place refrigerator in desired location and level. See "Installation Instructions."

WARNING



Electrical Shock Hazard

Plug into a grounded 3 prong outlet.
Do not remove the ground prong from the power cord plug.
Do not use an adapter.
Do not use an extension cord.
Failure to do so can result in death, fire or electrical shock.

3. Plug into grounded 3 prong outlet.

Troubleshooting

Try the solutions suggested here first in order to avoid the cost of an unnecessary service call.

Refrigerator operation

PROBLEM	POSSIBLE CAUSE(S)	SOLUTION
Refrigerator does not run	Refrigerator is unplugged.	Plug refrigerator into a grounded 3 prong outlet.
	Breaker is tripped or turned off, or fuse is blown.	Reset/Turn on breaker or replace fuse.
	Refrigerator is in defrost mode.	Wait for defrost cycle to end and cooling system to restart.
Refrigerator compressor runs frequently or for long periods of time Note: This refrigerator is designed to run for longer periods of time at a lower energy usage.	Refrigerator is first plugged in.	This is normal. Allow 24 hours for the refrigerator to cool down.
	Warm or large amounts of food added.	This is normal.
	Door is left open, or refrigerator is not level.	Check that an item is not preventing door from closing. Level the refrigerator. See "Level Refrigerator."
	Hot weather or frequent openings.	This is normal.
	Temperature control set to coldest setting.	Adjust temperature to a warmer setting.
Refrigerator has an odor	Food is not sealed or packaged properly.	Reseal packaging. Place an opened box of baking soda in the refrigerator, replace every 3 months.
	Interior needs to be cleaned.	Clean the interior. See "Cleaning."
	Food stored too long.	Dispose of spoiled food.
Light does not come on	Refrigerator is unplugged.	Plug refrigerator into a grounded 3 prong outlet.
	LED light is burned out.	Contact a qualified technician to replace the burned out LED.
Doors do not close properly	Refrigerator is not level.	See "Level Refrigerator."
	Something is obstructing door closure.	Check for and remove obstructions.
Vibration or rattling	Refrigerator is not resting firmly on floor.	See "Level Refrigerator."
Normal Sounds	It sounds like water is flowing from the refrigerator.	Refrigerant flowing in the lines will make this sound when the compressor starts and stops.
		The refrigerator has an automatic defrosting system. The defrosted water will make this sound.
	Humming or buzzing sounds	The compressor and fans used for cold air circulation can make this sound. If the refrigerator is not level, the sound will be louder.
	Cracking or clicking sounds	The interior parts will make this sound as they contract and expand in response to temperature changes.
	Popping noise	May occur during automatic defrosting.

Temperature and Moisture

PROBLEM	POSSIBLE CAUSE(S)	SOLUTION
Refrigerator or freezer is too warm	Temperature control is not set cold enough.	Adjust the compartment to a colder setting; allow 24 hours for the temperature to adjust.
	Doors opened frequently or left open.	Limit door openings to maintain the internal temperature. Check that an item is not preventing door from closing.
	Warm food added recently.	Allow time for food and refrigerator to cool.
	The space between the back of the refrigerator and the wall is too close.	Allow 5 cm space between the back of the refrigerator and the wall.
	Items against back of compartments are blocking proper airflow.	Store items only inside the trim of the glass shelves; don't place items against sides of the compartments or directly in front of any vents.
Refrigerator or freezer is too cold	Temperature control is set too cold.	Adjust temperature in the compartment to the next warmer setting; allow 24 hours for temperature to adjust.
Moisture on exterior/ interior of refrigerator	High humidity	This is normal during times of high humidity. Dry surface and adjust temperature to a slightly colder setting.
	Doors opened frequently or left open.	Keep door closed. Check that an item is not preventing the door from closing. Level the refrigerator. See "Level Refrigerator."
	Open container of water in refrigerator.	Cover or seal container
Frost or ice crystals on frozen food	Freezer door left open or opened frequently.	Limit door openings to maintain the internal temperature. Check that an item is not preventing door from closing.
	Refrigerator is not level.	Level the refrigerator. See "Level Refrigerator."
	Items blocking freezer air vents and preventing proper air flow.	Move items away from rear wall.
Food freezing in refrigerator	Food placed too close to the air vent.	Move items away from back and top of the refrigerator.
	Temperature control set too cold.	Adjust the temperature to a less cold setting.

Hisense

life reimagined