



OWNER'S MANUAL

REFRIGERATOR

Read this owner's manual thoroughly before operating the appliance and keep it handy for reference at all times.

EN ENGLISH



MFL70525002
Rev.00_072718

www.lg.com

Copyright © 2018 LG Electronics Inc. All Rights Reserved.

TABLE OF CONTENTS

This manual may contain images or content different from the model you purchased.

This manual is subject to revision by the manufacturer.

SAFETY INSTRUCTIONS	3
IMPORTANT SAFETY INSTRUCTIONS	3
INSTALLATION	11
Compartments	11
Dimensions and Clearances	12
Ambient Temperature	12
Removing/Assembling the Doors	13
Removing the Freezer Doors	14
Aligning the Doors	14
Leveling the appliance	15
Connecting the Appliance	16
Moving the Appliance	16
OPERATION	17
Parts and Functions	17
Notes for Operation	20
Using Control Panel	22
Folding Door Mullion	24
Door in Door (*)	24
Icemaker	24
Using the Folding Shelf (*)	25
Other Functions	25
SMART FUNCTIONS	26
Using the LG SmartThinQ Application	26
Using Smart Diagnosis™	28
MAINTENANCE	29
Notes for Cleaning	29
Cleaning the Condenser Cover	29
Cleaning the Fridge Shelf	30
Cleaning the Folding Shelf (*)	30
Cleaning the Vegetable Drawer	31
Cleaning the Door Basket	31
Cleaning the Freezer Drawer	32
Replacing the Pure N Fresh Filter	33
TROUBLESHOOTING	34

The following safety guidelines are intended to prevent unforeseen risks or damage from unsafe or incorrect operation of the appliance.
The guidelines are separated into 'WARNING' and 'CAUTION' as described below.

 This symbol is displayed to indicate matters and operations that can cause risk. Read the part with this symbol carefully and follow the instructions in order to avoid risk.

 **WARNING**

This indicates that the failure to follow the instructions can cause serious injury or death.

 **CAUTION**

This indicates that the failure to follow the instructions can cause the minor injury or damage to the product.

IMPORTANT SAFETY INSTRUCTIONS

 **WARNING**

To reduce the risk of explosion, fire, death, electric shock, injury or scalding to persons when using this product, follow basic precautions, including the following:

Children in the Household

- This appliance is not intended for use by persons (including children) with reduced physical, sensory or mental capabilities, or lack of experience and knowledge, unless they have been given supervision or instruction concerning use of the appliance by a person responsible for their safety. Children should be supervised to ensure that they do not play with the appliance.
- If the appliance is equipped with a lock (some models only), keep the key out of reach of children.

Installation

- This appliance should only be transported by two or more people holding the appliance securely.
- Ensure that the outlet socket is properly earthed, and that the earth pin on the supply cord is not damaged or removed from the plug. For more details on earthing, inquire at an LG Electronics customer information centre.
- This appliance is equipped with a power cord having an equipment-grounding conductor and a grounding power plug. The power plug must be plugged into an appropriate socket outlet that is installed and grounded in accordance with all local codes and ordinances.
- If the power cord is damaged or the hole of the socket outlet is loose, do not use the power cord and contact an authorized service centre.
- Do not plug the appliance into a multi socket adapter which does not have a power cable (mounted).
- Do not plug the appliance into a multi outlet power board, double adaptor or extension power cable.
- Do not modify or extend the power cord.
- The appliance should be connected to a dedicated power line which is separately fused.
- Do not use a multi socket outlet which is not properly grounded (portable). In case of using a properly-grounded multi socket outlet (portable), use the multi socket outlet with the current capacity of the power code rating or higher and use the multi socket outlet only for the appliance.
- Install the appliance in a place where is easy to unplug the power plug of the appliance.
- Be careful not to point the power plug up or let the appliance lean against the power plug.

- Install the appliance on a firm and level floor.
- Do not install the appliance in a damp and dusty place. Do not install or store the appliance in any outdoor area, or any area that is subject to weathering conditions such as direct sunlight, wind, rain, or temperatures below freezing.
- Do not place the appliance in direct sunlight or expose it to the heat from heating appliances such as stoves or heaters.
- Be careful not to expose the rear of the appliance when installing.
- Be careful not to let the appliance door fall during assembly or disassembly.
- Be careful not to pinch, crush, or damage the power cable during assembly or disassembly of the appliance door.
- Do not connect a plug adapter or other accessories to the power plug.

Operation

- Do not use the appliance for any purpose (storage of medical or experimental materials or shipping) other than any domestic household food storage use.
- Unplug the power plug during a severe lightening or thunderstorm or when not in use for a long period of time.
- Do not touch the power plug or the appliance controls with wet hands.
- Do not bend the power cable excessively or place a heavy object on it.
- If water penetrates electrical parts of the appliance, disconnect power plug and contact an LG Electronics customer information centre.
- Do not place hands or metallic objects inside the area emitting the cold air, cover or heat releasing grille on the back.
- Do not apply excessive force or impact to the back cover of the appliance.

- Do not put animals, such as pets into the appliance.
- Be careful of nearby children when you open or close the appliance door. The door may bump the child and cause injury. Do not allow any persons to swing from any of the doors as it can cause the unit to topple over and cause serious injury.
- Avoid the danger of children getting trapped inside the appliance. A child trapped inside the appliance can cause suffocation.
- Do not place heavy or fragile objects, liquid filled containers, combustible substances, or flammable objects (such as candles, lamps, etc.), or heating devices (such as stoves, heaters, etc.) on the appliance.
- If there is a gas leakage (isobutane, propane, natural gas, etc.), do not touch the appliance or power plug and ventilate the area immediately. This appliance uses a refrigerant gas (isobutane, R600a). Although it uses a small amount of the gas, it is still combustible gas. Gas leakage during appliance transport, installation or operation can cause fire, explosion or injury if sparks are caused.
- Do not use or store flammable or combustible substances (ether, benzene, alcohol, chemical, LPG, combustible spray, insecticide, air freshener, cosmetics, etc.) near the appliance.
- Immediately unplug the power plug and contact an LG Electronics customer information centre if you detect a strange sound, odour, or smoke coming from the appliance.
- Fill with potable water only into icemaker or dispenser water tank.
- Do not damage the refrigerant circuit.
- Do not place any electronic appliance (such as heater and mobile phone) inside the appliance.

Maintenance

- Disconnect the power cord before cleaning the appliance or replacing the inside lamp (where fitted).
- Securely plug the power plug in the socket outlet after completely removing any moisture and dust.

- Never unplug the appliance by pulling on the power cable. Always grip the power plug firmly and pull straight out from the socket outlet.
- Do not spray water or inflammable substances (toothpaste, alcohol, thinner, benzene, flammable liquid, abrasive, etc.) over the interior or exterior of the appliance to clean it.
- Do not clean the appliance with brushes, cloths or sponges with rough surfaces or which are made of metallic material.
- Only qualified service personnel from LG Electronics service centre should disassemble, repair, or modify the appliance. Contact an LG Electronics customer information centre if you move and install the appliance in a different location.
- Do not use a hair drier to dry the inside of the appliance or place a candle inside to remove the odours.
- Do not use mechanical devices or other means to accelerate the defrosting process.
- Connect the water supply line (for plumbed models only) to a potable water source only. Otherwise, impurities in the water may cause illness.

Disposal

- When discarding the appliance, remove the door gasket while leaving the shelves and baskets in place and keep children away from the appliance.
- Dispose of all packaging materials (such as plastic bags and styrofoam) away from children. The packaging materials can cause suffocation.

Technical Safety

- Keep ventilation openings, in the appliance enclosure or in the built-in structure, clear of obstruction.
- Do not use electrical appliances inside the refrigerator.

- The refrigerant and insulation blowing gas used in the appliance require special disposal procedures. Consult with service agent or a similarly qualified person before disposing of them.
- This appliance contains a small amount of isobutane refrigerant (R600a), but it is also combustible. When transporting and installing the appliance, care should be taken to ensure that no parts of the refrigerating circuit are damaged.
- Refrigerant leaking out of the pipes could ignite or cause an explosion.
- The amount of refrigerant in your particular appliance is shown on the identification plate inside the appliance.
- Never start up an appliance showing any signs of damage. If in doubt, consult your dealer.
- If a leak is detected, avoid any naked flames or potential sources of ignition and air the room in which the appliance is standing for several minutes. In order to avoid the creation of a flammable gas air mixture if a leak in the refrigerating circuit occurs, the size of the room in which the appliance is used should correspond to the amount of refrigerant used. The room must be 1 m² in size for every 8 g of R600a refrigerant inside the appliance.
- This appliance is intended to be used in household and similar applications only. It should not be used for commercial, or catering purposes, or in any mobile application such as a caravan or boat.
- Do not store explosive substances such as aerosol cans with a flammable propellant in this appliance.

CAUTION

To reduce the risk of minor injury to persons, malfunction, or damage to the product or property when using this product, follow basic precautions, including the following:

Installation

- Do not tilt the appliance to pull or push it when transporting.
- Make sure not to get a body part such as a hand or foot stuck while moving the appliance.

Operation

- Do not touch frozen food or the metal parts in the freezer compartment with wet or damp hands. It may cause frostbite.
- Do not place glass containers, bottles or cans (especially those containing carbonated drinks) in the freezer compartment, shelves or ice bin that will be exposed to temperatures below freezing.
- The tempered glass on the front side of the appliance door or the shelves can be damaged by an impact. If it is broken, do not touch it with hands.
- Do not place heavy objects on top of the door in door.
- Do not use the door in door as a chopping board and ensure it is not scratched by a sharp tool, as this may cause appliance damage.
- Do not hang from the appliance door, storage room, shelf or fridge door in door or climb up into it.
- Do not store an excessive amount of water bottles or containers for side dishes on the door baskets.
- Prevent animals from nibbling on the power cable or water hose.
- Do not open or close the appliance door with excessive force.
- If the hinge of the appliance door is damaged or operates improperly, stop using the appliance and contact an authorized service centre.
- Do not clean glass shelves or covers with warm water when they are cold.
- Never eat frozen foods immediately after they have been taken out in the freezer compartment.

- Make sure not to get a hand or foot stuck upon opening or closing the appliance door or door in door.
- Do not open the door of the appliance with the door in door open, or do not open the door in door while the door of the appliance is open. The door in door may be struck by the edge of the appliance and damaged.

Maintenance

- Do not insert the shelves upside down. The shelves may fall.
- To remove frost from the appliance, contact an LG Electronics customer information centre.

Compartments

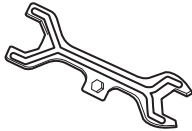
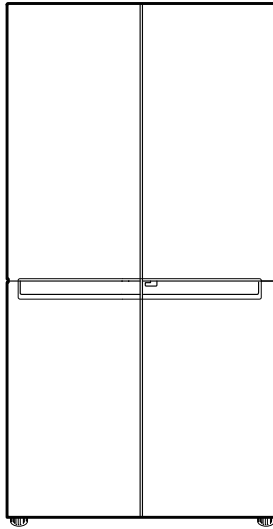

Spanner



Owner's Manual



C-Clip

- The appearance or components of the appliance may differ from model to model.

Dimensions and Clearances

- Too small of a distance from adjacent items may result in the degradation of freezing capability and increased electricity costs. Allow over 50 mm of clearance between the back of the appliance and the wall when installing the appliance.

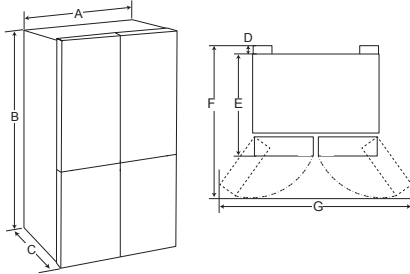

-	Size
A	835 mm
B	1787 mm
C	734 mm
D	5 mm
E	729 mm
F	1065 mm
G	1562 mm

Ambient Temperature

- The appliance is designed to operate within a limited range of ambient temperatures, depending on the climate zone. Do not use the appliance at a temperature exceeding the limit.
- The internal temperature could be affected by the location of the appliance, the ambient temperature, the frequency of door opening and so on.
- The climate class can be found on the rating label.

Climate Class	Ambient Temperature Range °C
SN (Extended Temperate)	+10 - +32
N (Temperate)	+16 - +32
ST (Subtropical)	+16 - +38
T (Tropical)	+16 - +43 / +10 - +43*

*Australia, India, Kenya

NOTE

- The appliances rated from SN to T are intended to be used at an ambient temperature between 10 °C and 43 °C.

Removing/Assembling the Doors

- When it is necessary to move the appliance through a narrow opening, removing the doors is the recommended procedure.

⚠ WARNING

- Disconnect the power cord, house fuse or circuit breaker before installing or servicing the appliance. Failure to follow these instructions may result in death, fire or electric shock.

Removing the Fridge Doors

- 1 Remove the top hinge cover screw (1) and the hinge cover (2).

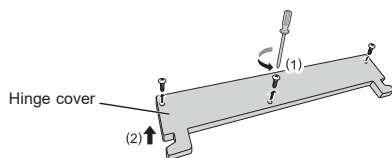

- 2 Remove the connector by pulling it in both directions by pressing down on the hook of the wire harness connector.

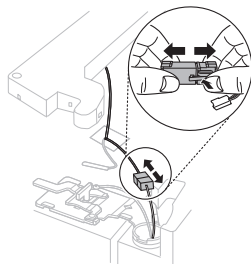

- 3 Rotate the hinge lever counterclockwise. Lift the top hinge free of the hinge lever latch.

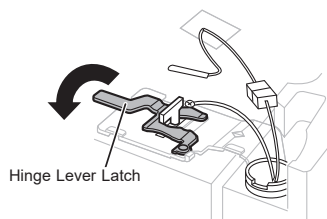

⚠ CAUTION

- It is recommended that two or more people carry out the door removal and refitting.
- When removing the upper hinge, be careful that the door does not fall forward.

- 4 Lift the door off of the middle hinge pin and remove the door.

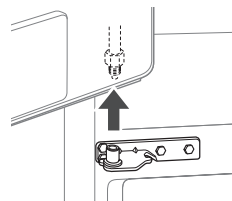

⚠ CAUTION

- Place the door on a non-scratching surface with the inner side facing up.

Refitting the Fridge Doors

Mount the doors in the reverse sequence of their removal once the appliance has been passed through all access doors.

Removing the Freezer Doors

After removing the fridge doors,

- 1 Remove the two hinge bolts.

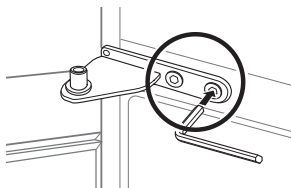

- 2 Twist the hinge to raise the pivoting end so that the door can be lifted off. Lift the door off the lower hinge pin and remove it.

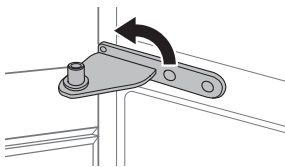

- 3 Remove the door by lifting it off the lower hinge pin.

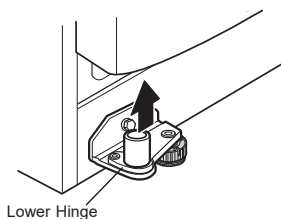

Refitting the Freezer Doors

Mount the doors in the reverse sequence of their removal once the appliance has been passed through all access doors.

Aligning the Doors

If the door is too low, lift the door up and screw on a door hinge bolt in the manner shown below using a spanner and a pair of long nose pliers.

Adjusting the Fridge Door

Adjusting Left Fridge Door

Open the fridge door and use the spanner to rotate the door hinge bolt as shown below.

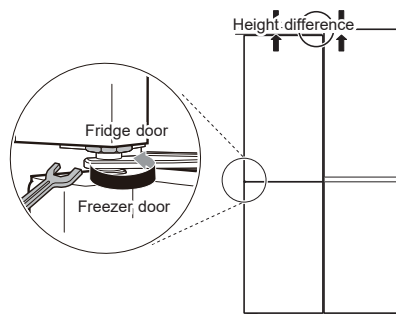

Adjusting Right Fridge Door

If the door is too low, lift the right door up and insert use a pair of long nose pliers to insert c-clips until both doors are level.

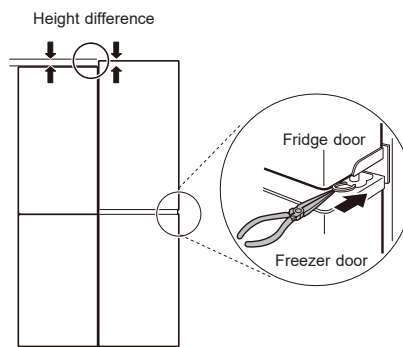

Adjusting the Freezer Door

If the door of the appliance is not level, adjust the difference in the height of appliance door using the following method.

NOTE

- Because the hinge pin may fall out, do not adjust the height of the appliance door more than 3 mm.

*Reference

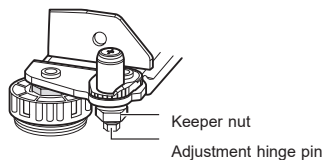

- 1 Loosen the keeper nut by rotating it counterclockwise using a 18 mm spanner.



- 2 Adjust the difference in the height of the appliance door by rotating the adjustment hinge pin clockwise or counterclockwise with an 8 mm spanner.



- 3 After adjusting the difference in the height of the appliance door, fasten the keeper nut by rotating it clockwise.



If it is impossible to adjust the height of the appliance door through the above method, level the door according to the following guide.

Leveling the appliance

If the door of the appliance is not level, adjust the difference in the height of appliance door using the following method.

NOTE

- Because the hinge pin may fall out, do not adjust the height of the appliance door more than 3 mm.

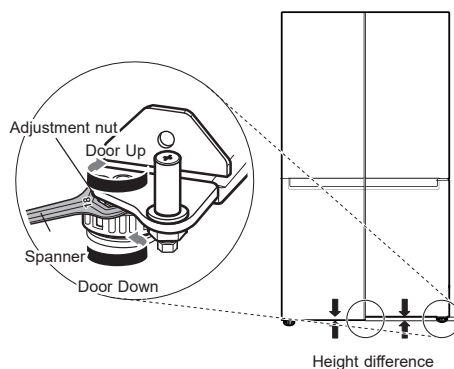

Open the door and use the supplied spanner to adjust the level of the lower side, using the nut on the adjustable round foot as per the below diagram.

Connecting the Appliance

After installing the appliance connect the power plug into a socket outlet.

After connecting the power supply cord (or plug) to the outlet, wait 2 or 3 hours before you put food into the appliance.

NOTE

- If you add food before the appliance has cooled completely, your food may spoil.

Moving the Appliance

- 1** Remove all food from inside the appliance.
- 2** Pull the power plug out, insert and fix it into the power plug hook at the rear or on top of the appliance.
- 3** Fix parts such as shelves and the door handle with tape to prevent from falling off while moving the appliance.
- 4** Move the appliance with more than two people carefully. When transporting the appliance over a long distance, keep the appliance upright.
- 5** After installing the appliance, connect the power plug into a socket out to switch on the appliance.

OPERATION

EN

Parts and Functions

Exterior

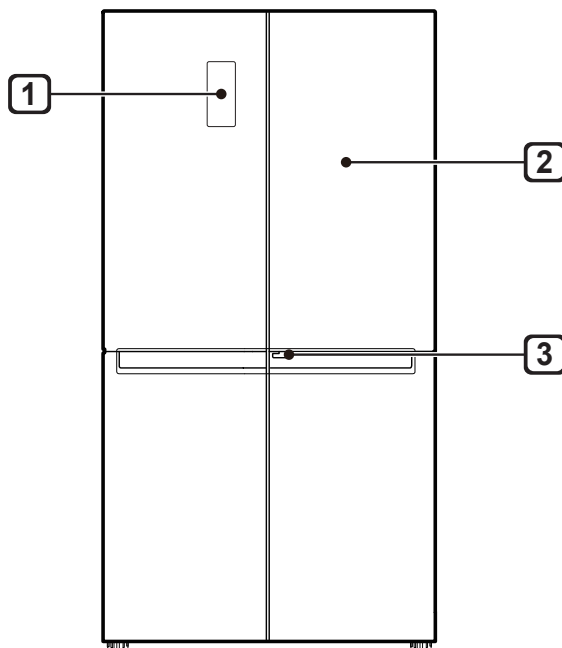

1 Control Panel

Sets the fridge and freezer temperatures.

2 Door-in-Door (*)

The Door-in-Door is a double layered door system. It can be opened individually or together with the main door. You can conveniently locate and access your favourite snacks or food items.

3 Door-in-Door Lever (*)

You can open the Door-in-Door by pulling the lever at the bottom of the door.

NOTE

- (*) means that this feature varies depending on the model purchased.
- The appearance or components of the appliance may differ from model to model.

Interior

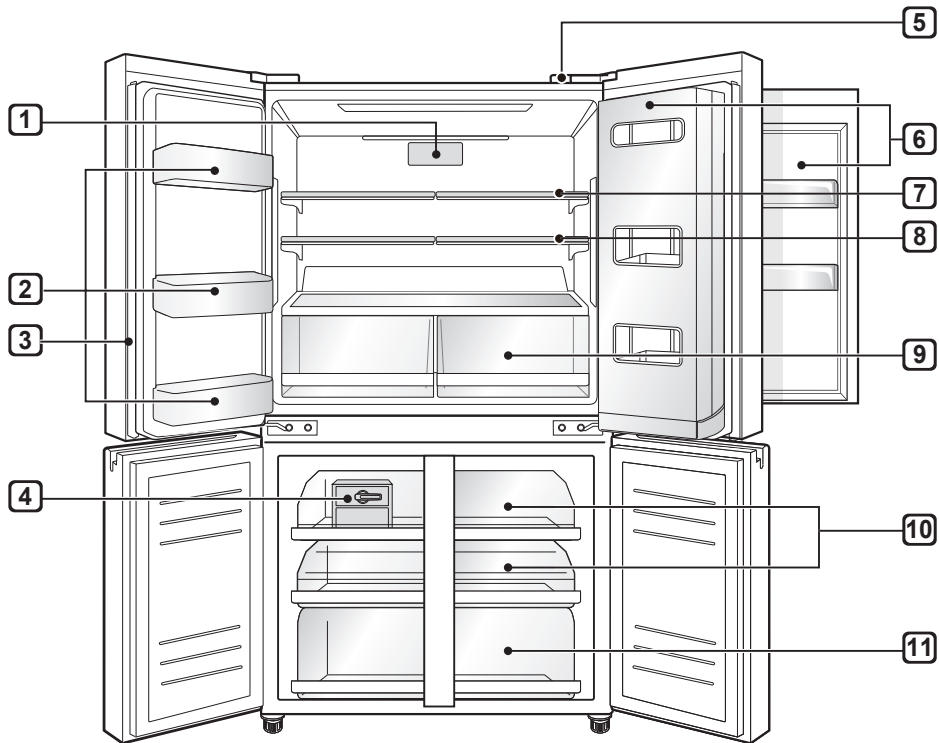

1 Pure N Fresh

This function reduces and removes odors inside the fridge compartment.

2 Fridge Door Basket

This is where small packages of refrigerated foods, drinks and sauce containers are stored.

3 Folding Door Mullion

This blocks the cold air of the fridge from escaping when the doors are closed.

⚠ CAUTION

- To reduce the risk of scratching the door or breaking the center door mullion, make sure that the fridge door mullion is always folded in.
- The door alarm will sound every 30 seconds if the door remains open longer than one minute. Ensure that the folding mullion is folded in before closing the left-hand door.

4 Moving Ice Maker

This is where ice is produced and stored.

5 Smart Diagnosis Unit

Use this function when contacting LG Electronics customer information centre to help make an accurate diagnosis when the appliance operates abnormally or a failure occurs.

6 Door-in-Door (*)

A convenient storage area for frequently-used items that require easy access.

7 Adjustable Fridge Shelf

Shelves are adjustable to meet individual storage needs.

8 Folding Shelf (*)

Shelf is adjustable to meet individual storage needs.

9 Vegetable Drawer

This is where fruits and vegetables are stored to remain fresh for as long as possible.

10 Freezer Tray

This is where frozen foods such as the meat, fish, and ice cream, can be stored.

- The sliding trays allow easy access and convenience of use.

11 Freezer Drawer

This is for long-term storage of frozen items.

- Preserve small packaged frozen food or frequently-taken out foods. To use larger space, remove drawers.

NOTE

- (*) means that this feature varies depending on the model purchased.

Notes for Operation

- Users should keep in mind that frost can form. If the door is not closed completely, if the humidity is high during the summer, or if the freezer door is opened frequently. Condensation build up within food storage wrappers is also caused by the same conditions.
- Ensure there is sufficient space between food stored on the shelf or door basket to allow the door to close completely.
- Opening the door lets warm air enter the appliance, and may cause the internal temperature to rise and condensation to form.
- If you are leaving the appliance turned off for an extended period of time, remove all food and unplug the power cord. Clean the interior, and leave the doors slightly ajar to prevent mold from growing in the appliance.

Suggestion for Energy Saving

- Ensure there is sufficient space between stored foods. This allows cold air to be circulated evenly and lowers electricity bills.
- Store hot food only after it has cooled in order to prevent dew or frost.
- When storing food in the freezer compartment, set the freezer temperature lower than the temperature indicated on the food.
- Do not put food near the temperature sensor of the fridge compartment. Keep a distance of at least 3 cm from the sensor.
- Note that a temperature rise after defrosting has a permissible range in the appliance specifications. If you wish to minimise the impact this may have on the food storage due to a temperature rise, seal or wrap the stored food in several layers.
- The automatic defrosting system in the appliance ensures that the compartment remains free of ice buildup under normal operating conditions.

Storing Foods Effectively

- Store frozen food or refrigerated food inside sealed containers. It is normal for condensation or frost to form inside sealed containers due to the moisture already in the container or bag prior to it being sealed.
- Check the expiration date and label (storage instructions) before storing food in the appliance.
- Do not store food for a long period of time (more than four weeks) if it spoils easily at a low temperature.
- Place the refrigerated food or frozen food in each fridge or freezer compartment immediately after purchasing.
- Avoid refreezing any food which has been completely thawed. Freezing any food which has been completely thawed again will lower its taste and nutrition.
- Do not wrap and store vegetables with newspaper. Printing material of newspaper or other foreign substances may smear and contaminate food.
- Do not overfill the appliance. Cold air can not circulate properly if the appliance is overfilled.
- If you set an excessively low temperature for food, it may become frozen. Do not set a temperature lower than the required temperature for the food to be stored correctly.
- If there are chill compartments in the appliance, do not store vegetables and fruits with higher moisture content in the chill compartments as they may freeze due to the lower temperature.

Max Freezing Capacity

- The Express Freeze function will allow the freezer to its maximum freezing capacity. This generally takes up to seven hours, however, it will automatically turn off after a given time and can also be turned off manually at any given time.
- To get better air circulation, insert all inner parts like baskets, drawers, and shelves.

Maximum Storage

- To get better air circulation, insert all drawers.
- If large quantities of food are to be stored, all the freezer drawers shall be taken out of the appliance except the bottom one and the food shall be stacked directly on the freezer shelves are freezer compartment.

NOTE

- To remove the drawers, first pick the food out of drawers. Then use the handle of drawers, pull out the drawers carefully. It may cause injury.
- The shape of each drawer may be different, insert in the right position.

Using Control Panel

Units and Functions

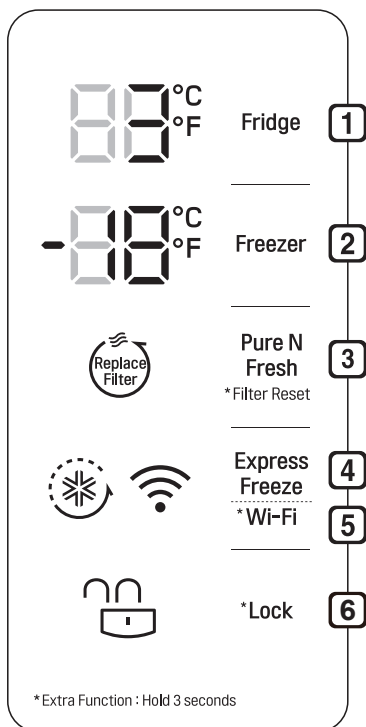

- 1 Fridge**
 - This sets the fridge target temperature.
- 2 Freezer**
 - This sets the freezer target temperature.
- 3 Pure N Fresh**
 - This function reduces and removes odors inside the fridge compartment.

NOTE

 - After changing the filter, push and hold the **Pure N Fresh** button for three seconds to reset the filter replacement reminder indicator.
- 4 Express Freeze**
 - This sets Express Freeze functions.
- 5 * Wi-Fi**
 - This sets the refrigerator to connect to your home's Wi-Fi network.
- 6 * Lock**
 - This locks the buttons on the control panel.

NOTE

- The actual control panel may differ from model to model.
- The control panel will turn off automatically for energy saving.
- If there is any finger or skin contacts to the control panel while cleaning it, the button function may operate.

Setting the Temperature

This sets the fridge temperature or freezer temperature.

- Press the **Fridge** button or **Freezer** button to adjust the temperature.
- The initial temperature is set.
 - Fridge : 3 °C
 - Freezer : -18 °C
- The temperature can be adjusted.
 - Fridge : from 0 °C to 6 °C
 - Freezer : from -24 °C to -16 °C
- The actual inner temperature varies depending on the food status, as the indicated setting temperature is a target temperature, not actual temperature within the appliance.

NOTE

- The default temperature setting may vary depending on the appliance.
- Wait until two or three hours have passed after connecting the appliance to the outlet before storing food in the appliance.
- For ice making in normal climates, the freezer temperature should be set to -18 °C or colder.

Setting Express Freeze

The function can quickly freeze a large amount of ice or frozen foods.

- When you press the **Express Freeze** button, the **Express Freeze** icon lights on the control panel.
- The function is enabled and disabled in turn each time you press the button.
- The Express Freeze function automatically terminates after a specific period has passed.

Setting and Resetting Lock

This locks the buttons on the control panel.

- When you press the **Lock** button for 3 seconds, the **Lock/Unlock** icon on the control panel lights. The function is enabled and disabled in turn each time you press the button.
- If you press a button other than lock when the lock is set, the button will not function.
- To change a setting, first press the **Lock** button for 3 seconds to disable the function.

NOTE

- The Lock function does not disable the dispenser operation.
- When you press a button other than lock when the lock is set, the **Lock/Unlock** icon on the control panel will flash 3 times.

Folding Door Mullion

This door mullion prevents cold air from leaking from the appliance.

⚠ CAUTION

- The door alarm will sound every 30 seconds if the door remains open longer than one minute. Ensure that the folding mullion is folded in before closing the left-hand door.

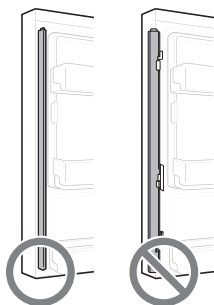

- To reduce the risk of door scratches and breaking the centre door mullion, make sure that the appliance door mullion is always folded in.

Door in Door (*)

Pull the lever at the bottom of the door upwards until the door in door opens.

There is plenty of storage space inside the door in door and its surrounding baskets, allowing you to store food in an organized manner.

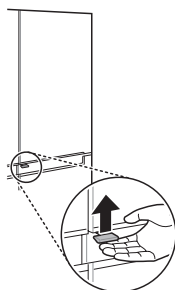

Removing the Case from the Door in Door

Hold the case from inside the door in door with both hands and remove it by lifting it upward.

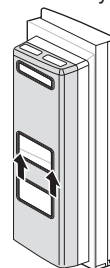

Refitting the Door in Door Case

Mount them in the reverse order of the removal process.

NOTE

- (*) means that this feature varies depending on the model purchased.

Icemaker

- 1 To make ice, fill the ice tray with water and insert it into its position.

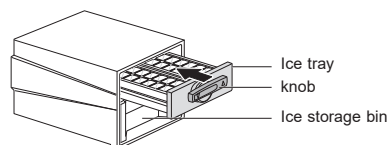

- 2 To take ice out, rotate the knob of the ice tray clockwise.

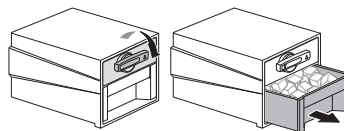

NOTE

- You can remove the icemaker or ice storage bin to create more space inside the freezer if you do not use it.

Using the Folding Shelf (*)

Store taller items, such as a gallon container or bottles, by pushing the front half of the shelf underneath the back half the shelf. Pull the front of the shelf forward to return to a full shelf.

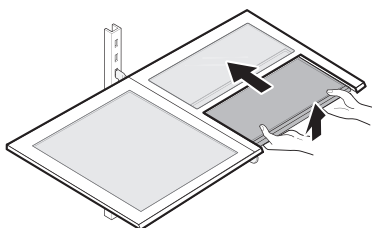
**CAUTION**

- Glass shelves are heavy. Use special care when removing them.
- Do not clean glass shelves with warm water while they are cold. Shelves may break if exposed to sudden temperature changes or impact.

NOTE

- (*) means that this feature varies depending on the model purchased.

Other Functions**Door Open Alarm**

The alarm sounds 3 times in 30 second intervals if the door (fridge compartment, freezer compartment, Door-in-Door) is left open or not completely closed for one minute.



- Contact the LG Electronics customer information centre if the alarm sound continues even after closing the door.

Failure Detection

The appliance can automatically detect problems during the operation.

- If a problem is detected, the appliance may not operate and an error code is displayed even when any button is pressed.
- If an error code is indicated on the display, Do not turn off the power. Immediately contact the LG Electronics customer information center and report the error code. If you turn off the power, the repair technician from the LG Electronics customer information centre may have difficulty finding the problem.

Using the LG SmartThinQ Application

- For appliances with the  or  logo

Things to check before using LG SmartThinQ

- 1 Check the distance between the appliance and the wireless router (Wi-Fi network).
 - If the distance between the appliance and the wireless router is too far, the signal strength becomes weak. It may take a long time to register or installation may fail altogether.
- 2 Turn off the **Mobile data** or **Cellular Data** on your smartphone.
 - For iPhones, turn data off by going to **Settings** → **Cellular** → **Cellular Data**.

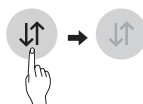

- 3 Connect your smartphone to the wireless router.



NOTE

- To verify the Wi-Fi connection, check that **Wi-Fi**  icon on the control panel is lit.
- The appliance supports 2.4 GHz Wi-Fi networks only. To check your network frequency, contact your Internet service provider or refer to your wireless router manual.
- LG SmartThinQ is not responsible for any network connection problems or any faults, malfunctions, or errors caused by network connection.

- If the appliance is having trouble connecting to the Wi-Fi network, it may be too far from the router. Purchase a Wi-Fi repeater (range extender) to improve the Wi-Fi signal strength.
- The Wi-Fi connection may not connect or may be interrupted because of the home network environment.
- The network connection may not work properly depending on the Internet service provider.
- The surrounding wireless environment can make the wireless network service run slowly.
- The appliance cannot be registered due to problems with the wireless signal transmission. Unplug the appliance and wait about a minute before trying again.
- If the firewall on your wireless router is enabled, disable the firewall or add an exception to it.
- The wireless network name (SSID) should be a combination of English letters and numbers. (Do not use special characters.)
- Smartphone user interface (UI) may vary depending on the mobile operating system (OS) and the manufacturer.
- If the security protocol of the router is set to **WEP**, you may fail to set up the network. Please change it to other security protocols (**WPA2** is recommended) and register the product again.

Installing LG SmartThinQ

Search for the LG SmartThinQ application from the Google Play Store or Apple App Store on a smart phone. Follow instructions to download and install the application.

Wi-Fi Function

Communicate with the appliance from a smart phone using the convenient smart features.

Firmware Update

Keep the appliance performance updated.

Smart Diagnosis™

If you use the Smart Diagnosis function, you will be provided with the useful information such as a correct way of using the appliance based on the pattern of use.

Settings

Allows you to set various options on the appliance and in the application.

NOTE

- If you change your wireless router, Internet service provider, or password, delete the registered appliance from the LG SmartThinQ application and register it again.
- The application is subject to change for appliance improvement purposes without notice to users.
- Functions may vary by model.

Connecting to Wi-Fi

The **Wi-Fi** button, when used with the LG SmartThinQ application, allows the refrigerator to connect to a home Wi-Fi network. The **Wi-Fi** icon shows the status of the refrigerator's network connection. The icon illuminates when the refrigerator is connected to the Wi-Fi network.

Initial Appliance Registration

Run the LG SmartThinQ application and follow the instructions in the application to register the appliance.

Re-registering the Appliance or Registering Another User

Press and hold the **Wi-Fi** button for 3 seconds to temporarily turn it off. Run the LG SmartThinQ application and follow the instructions in the application to register the appliance.

NOTE

- To disable the Wi-Fi function, press and hold the **Wi-Fi** button for 3 seconds. Wi-Fi icon will be turned off.

RF Radiation Exposure Statement

This equipment shall be installed and used at a minimum distance of 20 cm from the human body.



Open Source Software Notice Information

To obtain the source code under GPL, LGPL, MPL, and other open source licenses, that is contained in this product, please visit <http://opensource.lge.com>.

In addition to the source code, all referred license terms, warranty disclaimers and copyright notices are available for download.

LG Electronics will also provide open source code to you on CD-ROM for a charge covering the cost of performing such distribution (such as the cost of media, shipping, and handling) upon email request to opensource@lge.com. This offer is valid for a period of three years after our last shipment of this product. This offer is valid to anyone in receipt of this information.

Using Smart Diagnosis™

- For appliances with the  or  logo

Smart Diagnosis™ Through the Customer Information Centre

Use this function if you need an accurate diagnosis by an LG Electronics customer information centre when the appliance malfunctions or fails. Use this function only to contact the service representative, not during normal operation.

- 1 Press the **Lock** button to activate the lock function.
 - If the lock function has been activated already, press the **Lock** button to deactivate the lock function, and then press the **Lock** button again to activate the lock function.
 - Please note that the Smart Diagnosis function will not operate until five minutes has passed since the lock function was activated.

* Lock



- 2 Open the fridge door and then hold the phone on the upper right speaker hole.
 - Position the phone so that its microphone is aligned with the speaker hole.

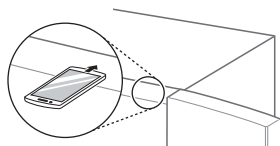

- 3 Press and hold the **Freezer** button for three seconds or longer while continuing to hold your phone to the speaker.

- 4 After the data transfer is complete, the service agent will explain the result of the Smart Diagnosis™.

NOTE

- Position the phone so that its microphone is aligned with the speaker hole.
- The Smart Diagnosis™ sound is generated after around three seconds.
- Hold the phone to the upper right speaker hole and wait while the data is transmitted.
- Do not take the phone off the speaker hole while the data is transmitted.
- The data transfer sound may be harsh to the ear while the Smart Diagnosis™ data is being transmitted, but do not take the phone off the speaker hole for accurate diagnosis until the data transfer sound has stopped.
- When the data transfer is complete, the transfer completion message is displayed and the control panel is automatically turned off and then on again after a few seconds. Afterwards the customer information centre explains the diagnosis result.
- The Smart Diagnosis™ function depends on the local call quality.
- The communication performance will improve and you can transmit a better signal if you use a land line home phone.
- If the Smart Diagnosis™ data transfer is poor due to poor call quality, you may not receive the best Smart Diagnosis™ service.

Notes for Cleaning

- When removing a shelf or drawer from inside the appliance, remove all stored foods from the shelf or drawer to prevent injury or damage to the appliance.
 - Otherwise, injury may occur due to the weight of stored foods.
- If cleaning the outside air vents of the appliance by means of vacuuming, then the power cord should be unplugged from the outlet to avoid any static discharge that can damage the electronics or cause an electric shock.
- Detach the shelves and drawers and clean them with water, and then dry them sufficiently, before replacing them.
- Regularly wipe the door gaskets with a wet soft towel.
- Door basket spills and stains should be cleaned as they can compromise storage ability of the basket and could even be damaged.
- After cleaning, check if the power cable is damaged.
- Keep the air vents on the exterior of the appliance clean.
 - Blocked air vents can cause fire or appliance damage.
- Waxing external painted metal surfaces helps provide rust protection. Do not wax plastic parts. Wax painted metal surfaces at least twice a year using appliance wax (or auto paste wax). Apply wax with a clean, soft cloth.
- When cleaning the inside or outside of the appliance, do not wipe it with a rough brush, toothpaste, or flammable materials. Do not use cleaning agents containing flammable substances.
 - This may cause discoloration or damage to the appliance.

- Flammable substances: alcohol (ethanol, methanol, isopropyl alcohol, isobutyl alcohol, etc.), thinner, bleach, benzene, flammable liquid, abrasive, etc.
- For the appliance exterior, use a clean sponge or soft cloth and a mild detergent in warm water. Do not use abrasive or harsh cleaners. Dry thoroughly with a soft cloth. Do not use contaminated cloths when cleaning the stainless steel doors. Always use a dedicated cloth and wipe in the same direction as the grain. This helps reduce surface staining and tarnishing.
- Never clean the shelves or containers in the dishwasher.
 - The parts may become deformed due to the heat.
- If the appliance is equipped with LED interior lamps, do not remove lamp cover and lamp in any attempt to repair or service it. Please, contact the LG Electronics customer information centre.

Cleaning the Condenser Cover

Use a vacuum cleaner with a brush to clean the condenser cover and vents. Do not remove the panel covering the condenser coil area.

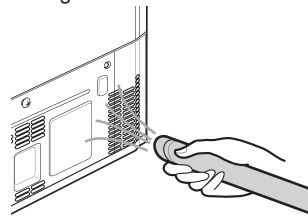

Cleaning the Fridge Shelf

Removing the Fridge Shelf

- 1 Open the fridge doors completely.
- 2 Tilt the front of the shelf up slightly and then lift the shelf straight up.



- 3 Pull the shelf out tilted at an angle.

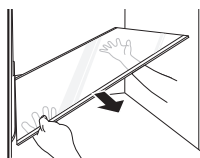

Refitting the Fridge Shelf

Refit the Shelf in the reverse sequence of their removal.

CAUTION

- Make sure that shelves are level from one side to the other. Failure to do so may result in the shelf falling or food spilling.
- Do not clean glass shelves with warm water while they are cold. Shelves may break if exposed to sudden temperature changes or impact.
- Glass shelves are heavy. Use special care when removing them.

Cleaning the Folding Shelf (*)

Removing the Folding Shelf

Tilt up the front of the shelf and lift it straight up. Pull the shelf out tilted at an angle.

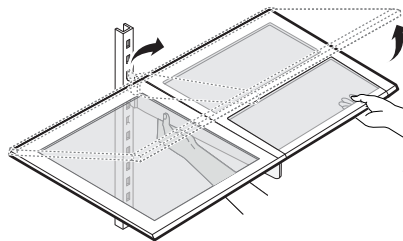

Refitting the Folding Shelf

Tilt the front of the shelf up and guide the rear shelf hooks into the slots at the desired height. Then, lower the front of the shelf so that the hooks drop into the slots.

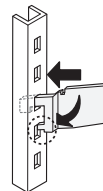

CAUTION

- Make sure that shelves are level from one side to the other. Failure to do so may result in the shelf falling or food spilling.

NOTE

- (*) means that this feature varies depending on the model purchased.

Cleaning the Vegetable Drawer

Removing the Vegetable Drawer

- 1 Open the doors completely and remove the contents of the Door-in-Door cases and baskets. Remove the Door-in-Door case from the appliance.

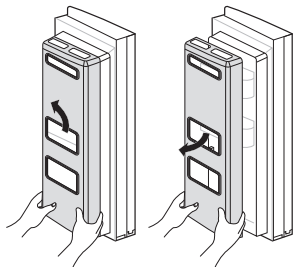

- 2 Remove the contents of the drawer. Hold the handle of the drawer and gently pull it out completely until it stops. Repeat to remove the second drawer.

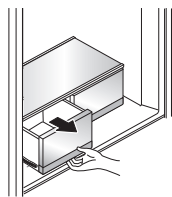

- 3 Tilt the cover slightly and support it with one hand.

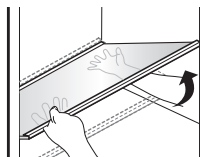

- 4 Pull the cover out tilted at an angle.

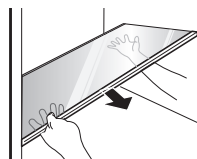

Refitting the Vegetable Drawer

- 1 Open the fridge doors completely.
- 2 Insert the bottom of the vegetable drawer into its original position and gently push it back in while lowering it.

Cleaning the Door Basket

Removing the Door Basket

Hold both edges of the basket and remove it by lifting it upward.

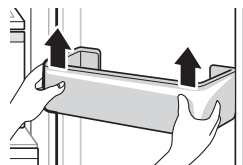

Refitting the Door Basket

Refit the Door Basket in the reverse sequence of their removal.

Cleaning the Freezer Drawer

The sliding freezer drawers allow easy access and convenience of use.

Use the upper compartments to store packaged frozen foods and frequently-used foods.

Use the lower compartment for larger frozen foods and items stored for longer periods.

Removing the Freezer Drawers

- 1 Open both freezer doors completely. Pull out the freezer trays and drawers to full extension and remove all of the contents.

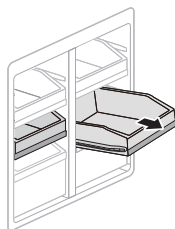

- 2 With the drawer fully extended, lift up the front and pull the drawer out to remove it.

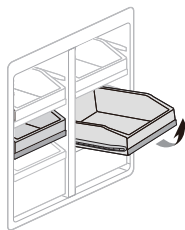

⚠ CAUTION

- The drawers are heavy. Always use two hands when removing or assembling the drawers to avoid product damage or personal injury.
- Always open the freezer doors completely before removing or assembling the drawers.

Assembling the Freezer Drawer

- 1 Open both freezer doors completely. Raise the front of the drawer slightly and insert the rollers on the drawer's sides into the guides in the freezer compartment.

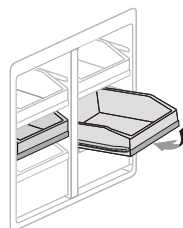

- 2 Gently push the drawer in while lowering it into place.

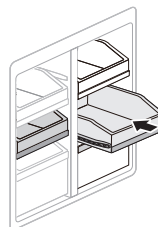

⚠ CAUTION

- The drawers are heavy. Always use two hands when removing or assembling the drawers to avoid product damage or personal injury.
- Always open the freezer doors completely before removing or assembling the drawers.

Replacing the Pure N Fresh Filter

To maintain the performance of the Pure N Fresh filter, if a message indicating the filter replacement is displayed, replace the filter as soon as possible.

- 1 If **Replace Filter** icon lights on the control panel, replace the Pure N Fresh filter.



- 2 Hold and remove the Pure N Fresh filter cover by rotating it counterclockwise until the hooks ① are separated completely.

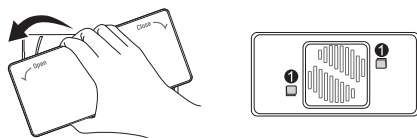

- 3 Remove the filter inside the Pure N Fresh filter cover and replace it with a new filter.

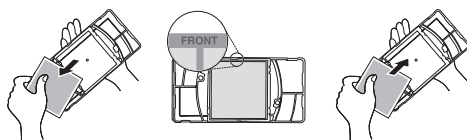

- 4 Hold and refit the air filter cover by rotating it clockwise until the hooks are engaged completely.

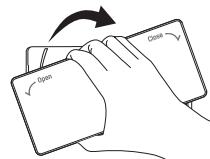

- 5 To reset the filter replacement period, press the **Pure N Fresh** button on the control panel for more than 3 seconds. The **Replace Filter** icon on the control panel will turn off. It will operate after replacing the filter.



NOTE

- Do not insert your finger or other foreign objects inside or its mounting. Doing so may result in injuries or malfunctions.
- If the replacement period has passed, the bacteria and odor removal performance may deteriorate.
- Please note that if you wash the filter with water, the filter performance may also deteriorate.
- Caution should be taken not to change the direction of the filter to be inserted into the filter cover.
- When setting the appliance to On or Power mode after replacing the filter, check if the LED lamp near the filter is on.
- The filter can be purchased from an LG Electronics customer information centre.

TROUBLESHOOTING

EN

Symptoms	Reason	Solution
There is no refrigeration or freezing.	Is there a power interruption?	• Check the power of other appliances.
	If the power plug unplugged from the outlet?	• Plug the power plug in the outlet properly.
There is poor refrigeration or freezing.	Is the fridge or freezer temperature set to its warmest setting?	• Set the fridge or freezer temperature to Mid setting or colder.
	Is the appliance in direct sunlight, or is it near a heat generating object such as cooking oven or heater?	• Check the installation area and reinstall it away from heat generating objects.
	Did you store hot food without cooling it first?	• Cool the hot food first before putting it in the fridge or freezer compartment.
	Did you put in too much food?	• Maintain an appropriate space between food.
	Are the appliance doors completely closed?	• Completely close the door and make sure that stored food is not obstructing in the door.
	Is there enough space around the appliance?	• Adjust the installation position to make enough space around the appliance.
The appliance contains a bad smell.	Is the fridge or freezer temperature set to 'Warm'?	• Set the fridge or freezer temperature to Mid setting or colder.
	Did you put in food with a strong smell?	• Store foods with strong smells in a sealed containers.
	Vegetables or fruit may have spoiled in the drawer?	• Throw away rotten vegetables and clean the vegetable drawer. Do not store vegetables too long in the vegetable drawer.
The inside lamp in the appliance does not turn on.	Does the inside lamp in the appliance turn off?	• It is not possible for customers to replace the inside lamp in the appliance as they are not serviceable. If the inside lamp does not turn on, please contact the LG Electronics customer information centre.
The appliance door is not closed tightly.	Is the appliance leaning forward?	• Adjust the front feet to raise the front side slightly.
	Were the shelves properly assembled?	• Refit the shelves if needed.
	Did you close the door with excessive force?	• If you apply too much force or speed when closing the door, it may remain briefly open before closing. Make sure that you do not slam the door closed. Close without force.

Symptoms	Reason	Solution
It is difficult to open the appliance door.	Did you open the door right after you closed it?	<ul style="list-style-type: none"> If you try to open the appliance door within one minute after you closed it, you may have difficulties because of the pressure inside the appliance. Try to open the appliance door again in a few minutes so that the internal pressure stabilizes.
Door mullion does not fold in and out properly.	Are front leveling legs extended, appliance level, and doors aligned?	<ul style="list-style-type: none"> Once the door baskets are filled, the doors may become misaligned, preventing the door mullion or the Auto Open Door function from working properly. Extend both front leveling legs fully so they are in firm contact with the floor. Follow the instruction in the Door Alignment section to raise the left appliance door until the door mullion is once again working properly. Adjust the right appliance door so it aligns with the left appliance door.
There is condensation inside the appliance or on the bottom of the vegetable drawer cover.	Did you store hot food without cooling it first?	<ul style="list-style-type: none"> Cool the hot food first before putting it in the fridge or freezer compartment.
	Did you leave the appliance door open?	<ul style="list-style-type: none"> Although the condensation will disappear soon after you close the appliance door, you can wipe it with a dry cloth.
	Do you open and close the appliance door too frequently?	<ul style="list-style-type: none"> Condensation can form due to the temperature difference from the outside. Wipe out the dampness with a dry cloth.
	Did you put warm or moist food inside without sealing it in a container?	<ul style="list-style-type: none"> Store food in a covered or sealed container.
Frost has formed in the freezer compartment.	Doors may not be closed properly?	<ul style="list-style-type: none"> Check if the food item inside the appliance is blocking the door and make sure that the door is tightly closed.
	Did you store hot food without cooling it first?	<ul style="list-style-type: none"> Cool the hot food first before putting it in the fridge or freezer compartment.
	Is the air entry or exit of the freezer compartment blocked?	<ul style="list-style-type: none"> Make sure that air entry or exit is not blocked so that the air can circulate inside.
	Is the freezer compartment overfilled?	<ul style="list-style-type: none"> Maintain an appropriate space between items.

Symptoms	Reason	Solution
Frost or condensation has formed inside or outside the appliance.	Did you open and close the appliance door frequently or is the appliance door improperly closed?	<ul style="list-style-type: none"> Frost or condensation can form if the outside air penetrates inside the appliance.
	Is the installation environment humid?	<ul style="list-style-type: none"> Condensation can appear on the exterior of the appliance if the installation area is too humid or on a humid day such as a rainy day. Wipe off any moisture with a dry cloth.
The appliance is noisy and generates abnormal sounds.	Is the appliance installed on a weak floor or improperly leveled?	<ul style="list-style-type: none"> Install the appliance on a firm and level floor.
	Does the rear of the appliance touch the wall?	<ul style="list-style-type: none"> Adjust the installation position to allow enough clearance around the appliance.
	Are objects scattered behind the appliance?	<ul style="list-style-type: none"> Remove the scattered objects from behind the appliance.
	Is there an object on top of the appliance?	<ul style="list-style-type: none"> Remove the object on top of the appliance.
The side or front of the appliance is warm.	There are anti condensation pipes fitted to these areas of the appliance to reduce condensation forming from around the door area.	<ul style="list-style-type: none"> The heat releasing pipe to prevent condensation is installed on the front and side of the appliance. You may feel it particularly hot right after the appliance is installed or during the summer. You can be assured that this is not a problem and is quite normal.
There is water inside or outside of the appliance.	Is there water leakage around the appliance?	<ul style="list-style-type: none"> Check if the water has leaked from a sink or another place.
	Is there water on the bottom of the appliance?	<ul style="list-style-type: none"> Check if the water is from the thawed frozen food or a broken or dropped container.

Symptoms	Reason	Solution
The automatic icemaker does not produce ice or produces a small amount of ice.	Did you install the appliance recently?	<ul style="list-style-type: none"> The ice maker produces ice normally when approximately 48 hours have passed after the appliance is installed.
	Did you connect the water supply pipe to the appliance and open the supply valve?	<ul style="list-style-type: none"> Connect the water supply pipe to the appliance and open the supply valve completely.
	Is the water supply hose bent?	<ul style="list-style-type: none"> If the water supply hose is bent, the water flow could be compromised.
	Have you dispensed a large amount of ice recently?	<ul style="list-style-type: none"> It takes approximately 24 hours to produce more ice in the automatic icemaker. Please wait.
	Did you set the ice maker switch or the automatic icemaker button on the control panel to ON?	<ul style="list-style-type: none"> Press I on the automatic icemaker switch or set ON for the automatic icemaker button on the control panel. (For more details on how to use, visit LG electronics website or use your smart device.)
	Is the temperature of the freezer compartment set too high?	<ul style="list-style-type: none"> If the set temperature is too warm, ice will be produced slowly or not at all. Set the Freezer temperature to -18 °C for normal operation of the automatic icemaker.
	Have you been opening the appliance door frequently?	<ul style="list-style-type: none"> If you open the appliance door frequently, cold air will escape, lowering the speed of ice production. Do not open and close the appliance door frequently.
	Is the appliance door completely closed?	<ul style="list-style-type: none"> If the appliance door is not completely closed, the temperature of the freezer compartment will increase, slowing down the ice production speed. Close the appliance door completely.
Ice is not dispensed.	Is there ice in the ice bin?	<ul style="list-style-type: none"> Check whether there is ice in the ice bin.
	Is the ice clumped in the ice bin?	<ul style="list-style-type: none"> Separate the ice bin and shake it. Discard the remaining clumped ice after shaking the ice bin.

Symptoms	Reason	Solution
Ice is not dispensed.	Unable to hear the sound of ice coming out?	<ul style="list-style-type: none"> In the control panel, select the modes for cubed ice and crushed ice alternately to dispense the ice.
	Is the ice path blocked? (You can check the ice passage by separating the ice bin.)	<ul style="list-style-type: none"> Ice may not be dispensed properly if the ice passage is blocked. Check the ice and clean the ice path regularly.
Water does not come out.	Are you using unfiltered water?	<ul style="list-style-type: none"> Unfiltered water can contain a large amount of various heavy metals or foreign substances, so the filter may be clogged in the early stage regardless of the life of the filter.
	The water dispenser tank may be empty? (For non plumbed models only)	<ul style="list-style-type: none"> Fill the water dispenser tank.
	Water does not come out when the water tube is filled with air. (For non plumbed models only)	<ul style="list-style-type: none"> Remove the water dispenser tank by pulling it out while holding the handle. Fill the water dispenser tank with water and refit it on the fridge shelf.
	The supply valve may be turned off? (For plumbed models only)	<ul style="list-style-type: none"> Open the water supply valve.
	Is the water supply valve closed? (For plumbed models only)	<ul style="list-style-type: none"> Open the water supply valve.
Water tastes strange.	Is the taste of water different when comparing it with the taste of water from the previous water purifier?	<ul style="list-style-type: none"> Has the purified water or cold water not been used for an extended period of time?
	Has it been a long time since you installed and replaced the filter?	<ul style="list-style-type: none"> If an expired filter is used, the purification performance may decline. It is recommended to replace the filter according to the filter replacement period.
	Have you flushed out the filter properly in the initial stage after installing it?	<ul style="list-style-type: none"> When you install or replace the filter for the first time, you need to remove air and activated carbon residue from inside the filter. Use the appliance after dispensing and discharging approximately 5 litres of purified water from the dispenser by pressing the water dispensing lever. (Activated carbon is harmless to humans.)
	Has the purified water or cold water not been used for an extended period of time?	<ul style="list-style-type: none"> The taste of old water may change due to bacterial growth. Use the product after dispensing and discharging approximately 5 litres (approximately three minutes) from the water dispenser.

Symptoms	Reason	Solution
Clicking noises	The defrost control will click when the automatic defrost cycle begins and ends. The thermostat control (or appliance control on some models) will also click when cycling on and off.	<ul style="list-style-type: none"> • Normal Operation
Rattling noises	Rattling noises may come from the flow of appliance, the water line on the back of the unit (for plumbed models only), or items stored on top of or around the appliance.	<ul style="list-style-type: none"> • Normal Operation
	Appliance is not resting evenly on the floor.	<ul style="list-style-type: none"> • Floor is weak or uneven or leveling legs need to be adjusted. See the Door Alignment section.
	Appliance with linear compressor was moved while operating.	<ul style="list-style-type: none"> • Normal operation. If the compressor does not stop rattling after three minutes, turn the power to the appliance off and then on again.
Whooshing noises	Evaporator fan motor is circulating air through the fridge and freezer compartments.	<ul style="list-style-type: none"> • Normal Operation
	Air is being forced over the condenser by the condenser fan.	<ul style="list-style-type: none"> • Normal Operation
Gurgling noises	Appliance flowing through the cooling system	<ul style="list-style-type: none"> • Normal Operation
Popping noises	Contraction and expansion of the inside walls due to changes in temperature.	<ul style="list-style-type: none"> • Normal Operation
Vibrating	If the side or back of the appliance is touching a cabinet or wall, some of the normal vibrations may make an audible sound.	<ul style="list-style-type: none"> • To eliminate the noise, make sure that the sides and back do not make any contact with any wall or cabinet.

Symptoms	Reason	Solution
<p>Your home appliance and smartphone is not connected to the Wi-Fi network.</p>	<p>The password for the Wi-Fi that you are trying to connect to is incorrect.</p>	<ul style="list-style-type: none"> Find the Wi-Fi network connected to your smartphone and remove it, then register your appliance on LG SmartThinQ.
	<p>Mobile data for your smartphone is turned on.</p>	<ul style="list-style-type: none"> Turn off the Mobile data of your smartphone and register the appliance using the Wi-Fi network.
	<p>The wireless network name (SSID) is set incorrectly.</p>	<ul style="list-style-type: none"> The wireless network name (SSID) should be a combination of English letters and numbers. (Do not use special characters.)
	<p>The router frequency is not 2.4 GHz.</p>	<ul style="list-style-type: none"> Only a 2.4 GHz router frequency is supported. Set the wireless router to 2.4 GHz and connect the appliance to the wireless router. To check the router frequency, check with your Internet service provider or the router manufacturer.
	<p>The distance between the appliance and the router is too far.</p>	<ul style="list-style-type: none"> If the distance between the appliance and the router is too far, the signal may be weak and the connection may not be configured correctly. Move the location of the router so that it is closer to the appliance.

Memo

