

Operating and installation instructions Steam combination oven



It is **essential** to read these operating and installation instructions before installing and using the appliance. This prevents both personal injury and damage to the appliance.

Contents

Warning and Safety instructions	7
Caring for the environment	16
Overview	17
Steam oven	17
Data plate	19
Accessories supplied	19
Controls	20
On/Off sensor	21
Display.....	21
Sensor controls	21
Symbols.....	23
Operating principles	24
Selecting a menu option	24
Changing a setting in a list.....	24
Changing the setting with a segment bar	24
Selecting a function.....	25
Entering numbers	25
Entering letters	25
Activating MobileStart	26
Description of the functions	27
Control panel.....	27
Water container	27
Condensate container	27
Temperature	27
Moisture.....	27
Cooking duration	28
Noises.....	28
Heating-up phase.....	28
Cooking phase	28
Steam reduction	29
Oven interior lighting	29
Before using for the first time	30
Miele@home	30
Standard settings	31
Cleaning for the first time	32
Setting the correct boiling point for water.....	33
Heating up the appliance	34

Settings	35
Settings overview	35
Opening the “Settings” menu.....	37
Language 	37
Time.....	37
Date	38
Lighting.....	38
Display.....	38
Volume.....	39
Units	39
Keeping warm	40
Steam reduction	40
Recommended temperatures.....	41
Booster	41
Water hardness	42
Automatic rinsing	43
Safety	43
Miele@home	44
Remote control.....	45
Activating MobileStart	45
RemoteUpdate	45
Software version.....	46
Showroom programme.....	46
Factory default.....	46
Minute minder	47
Main and sub-menus	49
Energy saving tips	51
Operation	53
Changing values and settings for a cooking programme.....	54
Changing the temperature.....	55
Changing the moisture level.....	55
Setting cooking durations	55
Changing the set cooking durations	56
Deleting the set cooking durations.....	57
Cancelling cooking.....	57
Interrupting a cooking programme.....	58
Pre-heating the oven	59
Booster.....	59
Pre-heat.....	60
Crisp function	60

Contents

Injecting bursts of steam.....	61
General notes	62
The advantages of cooking with steam	62
Suitable containers.....	62
Shelf level	63
Frozen	63
Temperature	63
Duration.....	63
Cooking with liquid.....	63
Your own recipes - steam cooking.....	63
Universal tray and combi rack.....	64
Steam cooking	65
Eco Steam cooking	65
Notes on the cooking charts	65
Vegetables.....	66
Fish.....	69
Meat	72
Rice	74
Grains	75
Pasta/Noodles	76
European dumplings	77
Dried pulses	78
Hen's eggs	80
Fruit	81
Sausages.....	81
Shellfish.....	82
Mussels	83
Menu cooking - manual.....	84
Sous-vide (vacuum) cooking	86
Other applications	94
Reheat	94
Defrost.....	96
Mix & Match	99
Menu cooking – automatic.....	110
Blanch	111
Bottling	111
Bottling cakes.....	114
Drying	115
Prove yeast dough	116
Disinfect items	116

Sabbath programme	117
Heat crockery	118
Keeping warm	118
Heat damp towels	119
Dissolve gelatine	119
Decrystallise honey	120
Melt chocolate.....	120
Make yoghurt	121
Render fat.....	122
Sweat onions.....	122
Extracting juice.....	123
Fruit jam.....	124
Skinning fruit and vegetables.....	125
Preserving apples	126
Preparing custard royale	126
Automatic programmes	127
Categories	127
Using Automatic programmes.....	127
Usage notes	127
User programmes.....	129
Baking.....	132
Baking guidelines	132
Tips on baking.....	133
Notes on the oven functions	133
Roasting	135
Roasting tips	135
Notes on the oven functions	135
Grilling	137
Grilling tips	137
Tips for grilling.....	137
Notes on the oven functions	138
Cleaning and care	140
Notes on cleaning and care.....	140
Unsuitable cleaning agents.....	141
Cleaning the front.....	141
PerfectClean.....	142
Oven compartment	143
Cleaning the water container and condensate container.....	144

Contents

Accessories	145
Cleaning the shelf runners.....	146
Lowering the top heat/grill element.....	147
Maintenance.....	148
Soaking	148
Drying	148
Rinsing.....	148
Descaling the steam oven	148
Removing the door.....	150
Fitting the door	151
Problem solving guide	152
Messages in the display	152
Unexpected behaviour	154
Noises.....	156
Unsatisfactory results.....	156
General problems or technical faults.....	157
Optional accessories	159
Cooking containers	159
Other.....	159
Cleaning and care products	159
Service	160
Contact in case of fault	160
Warranty	160
Installation	161
Safety instructions for installation	161
Installation dimensions.....	162
Installation in a tall unit.....	162
Installation in a base unit.....	163
Side view	164
Room for the control panel to open and close.....	165
Connection and ventilation.....	166
Installing the steam oven.....	167
Electrical connection	168
Copyright and licences for the communication module	169

Warning and Safety instructions

The steam combination oven is referred to in the following instructions as a steam oven.

This appliance complies with all current local and national safety requirements. However, inappropriate use can lead to personal injury and damage to property.

Please read these operating and installation instructions carefully before using the steam oven for the first time. They contain important information on safety, installation, use and maintenance of the appliance. This prevents both personal injury and damage to the steam oven.

In accordance with standard IEC 60335-1, Miele expressly and strongly advises that you read and follow the instructions in “Installation”, as well as in the “Warning and Safety instructions”.

Miele cannot be held liable for injury or damage caused by non-compliance with these instructions.

Keep these instructions in a safe place and pass them on to any future owner.

Warning and Safety instructions

Correct application

- ▶ This steam oven is designed for domestic use and for use in similar environments by guests in hotel or motel rooms, bed & breakfasts and other typical living quarters. This does not include common/shared facilities or commercial facilities within hotels, motels or bed & breakfasts.
- ▶ The steam oven is not suitable for outdoor use.
- ▶ The steam oven is intended only to steam, bake, roast, grill, defrost and reheat food.
Any other use is not permitted.
- ▶ This appliance is not intended for use by persons (including children) with reduced physical, sensory or mental capabilities, or lack of experience and knowledge, unless they have been given supervision or instruction concerning its use by a person responsible for their safety, and are able to recognise the dangers of misuse.
- ▶ This steam oven is supplied with a special lamp to cope with particular conditions (e.g. temperature, moisture, chemical resistance, abrasion resistance and vibration). This special lamp must only be used for the purpose for which it is intended. It is not suitable for room lighting. Replacement lamps may only be replaced by a Miele authorised technician.

Safety with children

- ▶ Activate the system lock to ensure that children cannot switch on the steam oven inadvertently.
- ▶ Young children must not be allowed to use this appliance.
- ▶ Older children may only use the appliance if its operation has been clearly explained to them and they are able to use it safely. They must be able to understand and recognise the possible dangers caused by incorrect operation.
- ▶ Cleaning may only be carried out by older children under the supervision of an adult.
- ▶ Please supervise children in the vicinity of the steam oven and do not let them play with it.
- ▶ Risk of suffocation from packaging material. Whilst playing, children may become entangled in packaging material (such as plastic wrapping) or pull it over their head with the risk of suffocation. Keep packaging material away from children.
- ▶ Risk of injury caused by hot surfaces. Children's skin is far more sensitive to high temperatures than that of adults. External parts of the steam oven such as the door glass, control panel and the vent become quite hot. Do not let children touch the steam oven when it is in operation.
Keep children well away from the steam oven until it has cooled down and there is no danger of injury.
- ▶ Risk of injury from the open door. The oven door can support a maximum weight of 10 kg. Children could injure themselves on an open door.
Do not let children sit on the open door, lean against it or swing on it.

Warning and Safety instructions

Technical safety

- ▶ Unauthorised installation, maintenance and repairs (including removal of any cover) can cause considerable danger for the user. Installation, maintenance and repairs must only be carried out by a Miele authorised technician.
- ▶ A damaged appliance is dangerous. Check the appliance for any visible damage. Never install or attempt to use a damaged appliance.
- ▶ Temporary or permanent operation with a self-sufficient or non-mains synchronous energy supply system (e.g. isolated networks, back-up systems) is possible. A requirement for the operation is that the energy supply system complies with all current local and national requirements that apply to stand-alone, solar and/or battery systems.

The protective measures provided in the installation and in this Miele product must also be assured in their function and operation in isolated operation or in non-mains synchronous operation, or replaced with equivalent measures in the installation.
- ▶ The electrical safety of this appliance can only be guaranteed when continuity is complete between it and an effective earthing system. It is most important that this basic safety requirement is present and tested regularly and, where there is any doubt, the household wiring system should be inspected by a qualified electrician.
- ▶ Before connecting the appliance to the mains supply, ensure that the connection data on the data plate (voltage and frequency) matches the mains electricity supply. This data must correspond in order to avoid the risk of damage to the appliance. Consult a qualified electrician if in any doubt.
- ▶ Do not connect the appliance to the mains electricity supply by a multi-socket adapter or an extension lead. These do not guarantee the required safety of the appliance (e.g. danger of overheating).

Warning and Safety instructions

- ▶ For safety reasons, this appliance may only be used after it has been built in.
- ▶ This appliance must not be installed and operated in mobile installations (e.g. on a ship).
- ▶ Risk of injury due to electric shock. Any contact with live connections or tampering with the electrical or mechanical components of the oven will endanger your safety and may lead to steam oven malfunctions.
Do not open the steam oven housing under any circumstances.
- ▶ The manufacturer's warranty will be invalidated if the appliance is not repaired by a Miele approved service technician.
- ▶ Faulty components must only be replaced by genuine Miele spare parts. The manufacturer can only guarantee the safety of the appliance when Miele replacement parts are used.
- ▶ If the electrical plug is removed from the mains connection cable or if the mains connection cable is supplied without a power plug, the steam oven must be connected to the electrical supply by a qualified electrician.
- ▶ If the mains connection cable is damaged, it must be replaced with a special mains connection cable by a qualified and competent electrician in order to avoid a hazard (see “Installation - Electrical connection”).
- ▶ During installation, maintenance and repair work, the appliance must be disconnected from the mains electricity supply. It is only completely isolated from the electricity supply when:
 - it is switched off at the mains circuit breaker, or
 - it is switched off at the wall socket and the plug is withdrawn from the socket. Do not pull the mains connection cable but the mains plug to disconnect your appliance from the mains electricity supply.

Warning and Safety instructions

▶ If the steam oven is installed behind a furniture front (e.g. a door), do not close the furniture front while the steam oven is in use. Heat and moisture can build up behind a closed furniture door. This can result in damage to the steam oven, the housing unit and the floor. Leave the furniture door open until the steam oven has cooled down completely.

▶ Warning: If the lamps need to be replaced, ensure they are replaced by a Miele approved service technician and that the appliance is switched off beforehand to avoid the possibility of an electric shock.

▶ In areas which may be subject to infestation by cockroaches or other vermin, pay particular attention to keeping the appliance and its surroundings clean at all times. Any damage caused by cockroaches or other vermin will not be covered by the warranty.

Correct use

▶ Risk of injury caused by hot surfaces and steam. The steam oven gets hot during operation. You could burn yourself on the heating elements, oven compartment, shelf runners, accessories, food or steam.

Wear oven gloves when placing food in the oven or removing it, and when adjusting oven shelves etc. in a hot oven.

▶ Risk of injury caused by hot food.

Food may spill or splash around when placing it into the oven or removing it. The food can cause burns.

When placing cooking containers in the oven or removing them, make sure that the hot food does not spill.

▶ Do not use the steam oven to heat up or bottle food in sealed tins. Pressure will build up inside them and they can explode causing damage to the appliance, as well as the risk of injury and scalding.

Warning and Safety instructions

- ▶ Plastic containers which are not heat-resistant will melt, and may ignite, at high temperatures and can damage the steam oven. Use only heat-resistant plastic containers. Please follow the container manufacturer's instructions. If you want to use plastic containers in your steam oven, make sure they can resist high temperatures and steam. Other plastic containers may melt, distort or break.
- ▶ Food which is left in the oven compartment can dry out and the moisture released can lead to corrosion damage in the steam oven. Do not leave food in the oven compartment and do not use any cooking containers which are susceptible to corrosion.
- ▶ Risk of injury from the open door. You could bang into the open door or trip over it. Avoid leaving the door open unnecessarily.
- ▶ The door can support a maximum load of 10 kg. Do not sit on or lean against an open door, and do not place heavy objects on it. Also make sure that nothing can get trapped between the door and the oven compartment. The steam oven could get damaged.
- ▶ Oil and fat can ignite if overheated. Never leave the steam oven unattended when cooking with oil and fat. If it does ignite, do not put the flames out with water. Switch the steam oven off immediately and then suffocate the flames by keeping the oven door closed.
- ▶ Due to the high temperatures radiated, objects left near the steam oven when it is in use could catch fire. Do not use the steam oven to heat up the room.
- ▶ Grilling food for excessively long cooking durations can cause it to dry out with the risk of catching fire. Do not exceed the recommended cooking durations.

Warning and Safety instructions

▶ Certain foods dry out quickly and may catch fire due to high grilling temperatures.

Never use a grill function to finish baking bake-off rolls or bread, or to dry flowers or herbs. Use the Fan Plus  or Conventional Heat functions instead.

▶ To avoid fuelling any flames, do not open the oven door if there is smoke inside the steam oven. Interrupt the programme by switching the steam oven off and disconnect it from the mains electricity supply. Do not open the door until the smoke has dispersed.

▶ If using alcohol in your recipes, please be aware that high temperatures can cause the alcohol to vaporise and even to ignite on the hot heating elements.

▶ Never line the floor of the oven compartment with aluminium foil or oven liners. Do not place any crockery or any pans, pots or baking trays directly on the floor of the oven compartment.

If you want to use the floor of the oven compartment as an extra surface, place the rack on the floor of the oven compartment with the rack surface facing up and the cooking container on top. In doing so, ensure that the filter in the floor of the oven is not moved.

▶ The oven compartment floor can become damaged by the rack being pushed around on it.

Do not push the rack around on the oven compartment floor.

▶ Larger deposits of food can block the drain and pump. Always make sure that the filter in the floor of the oven is inserted.

▶ When using a small electrical appliance, e.g. a hand-held blender, near the steam oven, care should be taken that the cable of the appliance cannot get trapped by the steam oven door. The insulation on the cable could become damaged, giving rise to an electric shock hazard.

▶ Do not operate the appliance without the lamp cover. Steam could attack the electrical components and cause a short circuit. Steam could also damage the electrical components.

Cleaning and care

- ▶ Risk of injury due to electric shock. The steam from a steam cleaning appliance could reach electrical components and cause a short circuit. Never use a steam cleaner for cleaning.
- ▶ Scratches on the door glass can result in the glass breaking. Do not use abrasive cleaners, hard sponges, brushes or sharp metal tools to clean the door glass.
- ▶ The shelf runners can be removed (see “Cleaning and care – Cleaning the shelf runners”). Refit the shelf runners correctly.
- ▶ Try to avoid the interior walls being splashed with food or liquids containing salt. If it does happen, wipe these away thoroughly to avoid corrosion on the stainless steel surface.

Accessories

- ▶ Use only genuine original Miele spare parts. If spare parts or accessories from other manufacturers are used, the warranty will be invalidated, and Miele cannot accept liability.
- ▶ Miele will guarantee to supply functional spare parts for a minimum of 10 years and up to 15 years following the discontinuation of your steam oven.

Caring for the environment

Disposal of the packing material

The transport and protective packaging has been selected from materials which are environmentally friendly for disposal, and can normally be recycled.

Recycling the packaging reduces the use of raw materials in the manufacturing process and also reduces the amount of waste in landfill sites. Ensure that any plastic wrappings, bags etc. are disposed of safely and kept out of the reach of babies and young children. Danger of suffocation.

Disposing of your old appliance

Electrical and electronic appliances often contain valuable materials. They also contain specific materials, compounds and components, which were essential for their correct function and safety. These could be hazardous to human health and to the environment if disposed of with your domestic waste or if handled incorrectly. Please do not, therefore, dispose of your old appliance with your household waste.



Please dispose of it at your local community waste collection / recycling centre for electrical and electronic appliances. You are also responsible for deleting any personal data that may be stored on the appliance prior to disposal. Please ensure that your old appliance poses no risk to children while being stored prior to disposal.

Steam oven

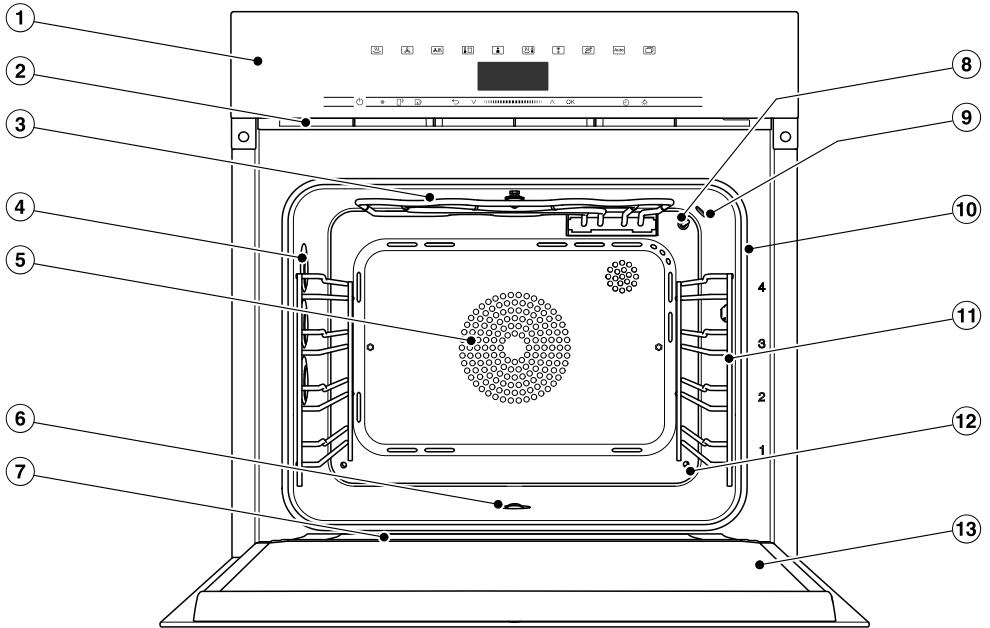

- ① Control panel
- ② Ventilation outlet
- ③ Top heat/grill element
- ④ Oven interior lighting
- ⑤ Air inlet for the fan with ring heating element behind it
- ⑥ Oven floor with bottom heating element and floor filter underneath it
- ⑦ Drip channel
- ⑧ Temperature sensor
- ⑨ Moisture sensor
- ⑩ Door seal
- ⑪ Shelf runners with 4 shelf levels
- ⑫ Steam outlet
- ⑬ Door

Overview



- ① Condensate container
- ② Compartment for the condensate container
- ③ Compartment for water container
- ④ Water container

A list of the models described in these operating and installation instructions can be found on the back page.

Data plate

The data plate is located on the top of the housing.

The data plate states the model number, the serial number as well as connection data (mains voltage, frequency and maximum rated load).

The model code and the serial number (SN) can also be found on the small plate on top on the opened control panel.

Please have this information to hand should you need to contact Miele regarding any questions or problems.

Accessories supplied

The accessories supplied with your appliance, as well as a range of optional ones, are available to order from Miele (see "Optional accessories").

DGG 20

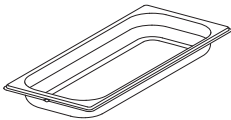

1 solid cooking container
Gross capacity 2.4 litres / Useable capacity 1.8 litres
450 x 190 x 40 mm (W x D x H)

DGGL 20

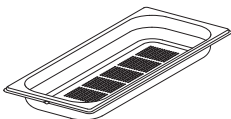

1 perforated cooking container
Gross capacity 2.4 litres / Useable capacity 1.8 litres
450 x 190 x 40 mm (W x D x H)

Universal tray

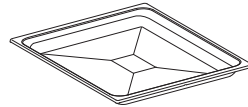

1 universal tray for baking, roasting and grilling

Combi rack



1 combi rack for baking, roasting and grilling

Insert these accessories into the shelf runners between the two rails of a shelf level.

The rack has a rail at the back to prevent dishes sliding off. Ensure the rack is inserted so that the rail is facing upwards.

Non-tip safety notches are located on accessories to prevent the trays being pulled out completely when you only wish to pull them out partially. They also prevent trays from tipping.







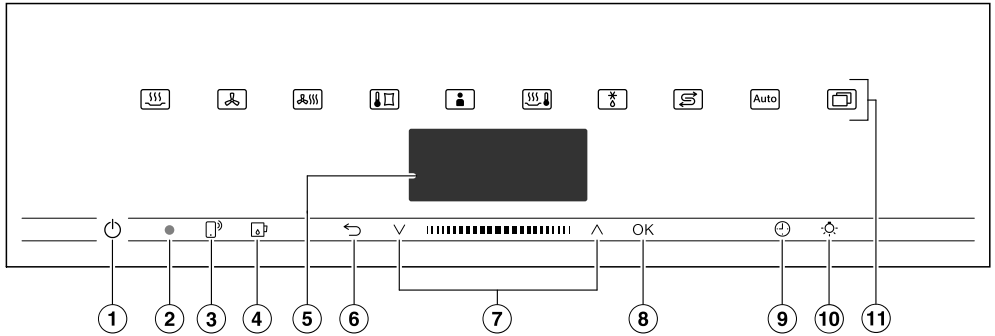

- The non-tip safety notches are located in the middle of the short sides of the baking tray and universal tray.
- The non-tip safety notches are located towards the back of the short sides of the rack.

Descaling tablets

For descaling the appliance.

Controls



- ① Recessed On/Off  sensor
For switching the steam oven on and off
- ② Optical interface
(for Miele service technicians only)
- ③  sensor
For controlling the steam oven via your mobile device
- ④  sensor
For opening and closing the control panel
- ⑤ Display
For displaying the time of day and information on operation
- ⑥  sensor
For going back a step and for changing menu options during a cooking programme
- ⑦ Navigation area with  and  arrow sensors
For scrolling through lists and for changing values
- ⑧ OK sensor
For calling up functions and saving settings
- ⑨  sensor
For setting a minute minder, the cooking duration or the start or finish time for the cooking programme
- ⑩  sensor
For switching the oven interior lighting on and off
- ⑪ Sensor controls
For selecting functions, Automatic programmes and settings

On/Off sensor

The On/Off  sensor is recessed and reacts to touch.

Use this sensor to switch the steam oven on and off.

Display

The display is used for showing the time of day or information about functions, temperatures, cooking durations, Automatic programmes and settings.

After switching the steam oven on with the On/Off  sensor, Select function will appear in the main menu.

Sensor controls

The sensors react to touch. Every touch of the sensors is confirmed by a keypad tone. You can switch off this keypad tone using Other  | Settings | Volume | Keypad tone.





If you want the sensor controls to respond even when the steam oven is switched off, select the Display | QuickTouch | On setting.



Sensor controls above the display

For information on the oven functions and further functions, see “Main and sub-menus”, “Settings”, “Automatic programmes” and “Other applications”.

Controls





Sensor controls under the display

Sensor	Function
	<p>If you want to control the steam oven from your mobile device, you must have the Miele@home system, switch on the Remote control setting and touch this sensor. The sensor then lights up orange and the MobileStart function is available.</p> <p>As long as this sensor is illuminated, you can control the steam oven via your mobile device (see “Settings – Miele@home”).</p>
	<p>Use this sensor to open and close the control panel (see “Description of the functions - Control panel”).</p>
	<p>Depending on which menu you are in, this sensor control will take you back a level or back to the main menu.</p> <p>If a cooking programme is in progress at the same time, use this sensor control to change values and settings such as the temperature or Booster function for the programme, or to cancel the programme.</p>
	<p>In the navigation area, use the arrow sensors or the area between them to scroll up and down in the selection lists. The menu options will be highlighted one after the other as you scroll through them. The desired menu option must be highlighted before you can select it.</p> <p>You can change the values or settings that are highlighted by using the arrow sensors or the area between them.</p>
OK	<p>Functions highlighted in the display can be selected by touching the OK sensor. The selected function can then be changed.</p> <p>Confirm with OK to save changes.</p> <p>If information appears in the display, select OK to confirm the message.</p>

Sensor	Function
	<p>If no cooking programme is in progress, you can use this sensor to set a minute minder (e.g. when boiling eggs on the cooktop) at any point.</p> <p>While a cooking programme is in progress, you can set a minute minder, the cooking duration and a start or finish time for the programme.</p>
	<p>Select this sensor to switch the oven interior lighting on and off.</p> <p>Depending on the setting selected, the oven interior lighting switches off after 15 seconds or remains constantly switched on or off.</p>

Symbols

The following symbols may appear in the display:

Symbol	Meaning
	This symbol indicates that there is additional information and advice about using the appliance. Select <i>OK</i> to confirm the information.
	Minute minder
	A tick indicates the option which is currently selected.
	Some settings, e.g. display brightness and signal tone volume, are selected using a segment bar.

Operating principles

Use the \wedge and \vee arrow sensors or the  area between them in the navigation area to operate the steam oven.

The *OK* sensor lights up orange as soon as a value, setting or prompt needs to be confirmed.

Selecting a menu option

- Touch the \wedge or \vee arrow sensor or swipe to the right or left in the  area until the desired menu option is highlighted.

Useful tip: If you press and hold the arrow sensor, the list continues scrolling automatically until you release the arrow sensor.

- Confirm your selection with *OK*.

Changing a setting in a list

- Touch the \wedge or \vee arrow sensor or swipe to the right or left in the  area until you reach the desired value or the desired setting is highlighted.

Useful tip: A \checkmark tick will appear beside the current setting.

- Confirm with *OK*.

The setting is now saved. This will take you back to the previous menu.

Changing the setting with a segment bar

Some settings are represented by a  bar with seven segments. If all of the segments are illuminated, the maximum value is selected.

If none or only one of the segments is illuminated, the minimum value is selected or the setting is switched off altogether (e.g. volume).

- Touch the \wedge or \vee arrow sensor or swipe to the right or left in the  area until you reach the desired setting.
- Confirm your selection with *OK*.

The setting is now saved. This will take you back to the previous menu.

Selecting a function

The sensor controls for the functions are located above the display (see “Operation” and “Settings”).

- Touch the sensor for the desired function.

The sensor on the control panel will light up orange.

- Under Other , scroll through the lists until the desired menu option is highlighted.
- Set the values for the cooking programme.
- Confirm with *OK*.

Changing the function

You can change to another function during a cooking programme.

The sensor for the previously selected function lights up orange.

- Touch the sensor for the new function.

The new function appears in the display with its corresponding recommended values.

The sensor for the new function lights up orange.

Under Other , scroll through the lists until you reach the desired menu option.

Entering numbers

Numbers that can be changed are highlighted.

- Touch the \wedge or \vee arrow sensor or swipe to the right or left in the  area until the desired number is highlighted.

Useful tip: If you press and hold an arrow sensor, the numbers continue scrolling automatically until you release the arrow sensor.

- Confirm with *OK*.

The changed number is now saved. This will take you back to the previous menu.

Entering letters

Letters are entered via the navigation area. It is best to select short, memorable names.

- Touch the \wedge or \vee arrow sensor or swipe to the right or left in the  area until the desired character is highlighted.

The character you have selected will appear in the top line of the display.

Useful tip: A maximum of 10 characters can be used.

You can delete the characters one at a time with \leftarrow .

- Select further characters.
- Once you have entered the name, select \checkmark .
- Confirm with *OK*.

The name is now saved.

Operating principles

Activating MobileStart

- Select the  sensor to activate MobileStart.

The  sensor lights up. You can operate your steam oven remotely with the Miele App.

Directly operating the steam oven takes priority over operating it via the remote control function on the App.

You can use MobileStart as long as the  sensor is lit up.

Control panel

The water container and the condensate container are located behind the control panel. The panel is opened and closed by touching the  sensor. It is fitted with anti-trapping protection. If the control panel senses resistance when opening/closing, the process is cancelled. Do not touch the upper edge of the door when the panel is opening and closing.

Water container

The maximum filling volume is 1.4 litres and the minimum is 1.0 litre. There are markings on the water container. The upper marking must never be exceeded.

Water consumption depends on the type of food and the cooking duration. The water may need to be topped up during cooking. Water consumption is increased if the door is opened during cooking.

Fill the water container to the maximum level before each cooking programme involving steam.



Condensate container

Condensate that collects in the appliance from cooking is pumped into the condensate container. The container has a maximum capacity of 1.4 litres.

Temperature

Some functions are allocated with a recommended temperature. The recommended temperature can be altered within the given range for an individual cooking programme or programme stage, or for every time that programme is used. You can alter the recommended temperature in 5 °C increments, or 1 °C increments in sous-vide cooking (see “Settings – Recommended temperatures”).

Moisture

The Combi mode  function and Reheat  application use a combination of oven heat and moisture. The moisture level can be selected within the given range for an individual programme or a specific programme stage.

Depending on the moisture setting, moisture or fresh air is supplied to the oven compartment. With the moisture setting = 0%, the maximum fresh air supply is implemented and no moisture is supplied. With the moisture setting = 100%, there is no fresh air supply and the moisture content is at its maximum.

Some food gives off moisture during the cooking process. This moisture from the food affects the amount of additional moisture needed. If the required amount of moisture is low, the steam generator may not be activated at all.

Description of the functions

Cooking duration

Depending on the function, you can set a cooking duration of between 1 minute and 10 or 12 hours.

The cooking durations of the Automatic and Maintenance programmes are set at the factory and cannot be altered.

When cooking with steam, as well as for programmes and applications with pure steam operation, the cooking duration does not begin until the set temperature is reached. It starts immediately for all other functions, programmes and applications.

Noises

A humming sound can be heard during operation and after switching off the steam oven. This noise does not indicate incorrect operation or an appliance fault. The noise is made by water being pumped through the system.

When the steam oven is in use, you will hear a fan noise.

Heating-up phase

The display shows the temperature in the oven compartment as it rises during the heating-up phase in all functions (exceptions: Full Grill, Economy Grill).

The duration of the heating-up phase with steam cooking will depend on the quantity and temperature of the food. In general, the heating-up phase will take approx. 7 minutes. It will be longer if you are cooking refrigerated or frozen food. The heating-up phase may also take longer when cooking at lower temperatures and when cooking with the Sous-vide  function.

Cooking phase

The elapsing remaining time is shown in the display during the cooking phase. When cooking with steam, the cooking phase begins once the set temperature is reached. It starts immediately for all other functions, programmes and applications.

Steam reduction

With steam cooking and Combi mode, the steam reduction function will switch on automatically at the end of a cooking programme which uses a temperature within a certain temperature range. This is to prevent a large amount of steam escaping when the door is opened.

Steam reduction appears in the display.

Steam reduction can be switched off (see “Settings - Steam reduction”).

When steam reduction is switched off, a large amount of steam will escape when the door is opened.

Oven interior lighting

For energy saving reasons, the oven interior lighting has been set at the factory to go out after the programme has begun.

If you want the lighting to remain on during cooking, the relevant setting needs to be changed (see “Settings – Lighting”).

If the door is left open at the end of a cooking programme, the oven lighting will switch off automatically after 5 minutes.

The lighting can be switched on for 15 seconds by touching the  sensor on the control panel.

Before using for the first time

Miele@home

Your steam oven is equipped with an integrated Wi-Fi module.

In order to use it, you need:

- a Wi-Fi network
- the Miele App
- a Miele user account. The user account can be created via the Miele App.

The Miele App will guide you as you connect your steam oven to your home Wi-Fi network.

Once your steam oven is connected to your Wi-Fi network, you can use the App for a number of actions, including the following:

- Call up information on the operating status of your steam oven
- Retrieve information on cooking processes that are in progress
- End cooking programmes that are in progress

Connecting your steam oven to your Wi-Fi network will increase energy consumption, even when the steam oven is switched off.

Make sure that the signal of your Wi-Fi network is sufficiently strong in the place where your steam oven is installed.

Availability of the Wi-Fi connection

The Wi-Fi connection shares a frequency range with other appliances (including microwave ovens and remote control toys). This may result in sporadic or even complete connection failures. Therefore, a constant availability of featured functions cannot be guaranteed.

Miele@home availability

The ability to use the Miele App depends on the availability of the Miele@home service in your country.

The Miele@home service is not available in every country.

For information about availability, please visit www.miele.com.

Miele App

You can download the Miele App from the Apple App Store® or the Google Play Store™ free of charge (only functional in selected countries).



Before using for the first time

Standard settings

The following settings must be made before starting up for the first time. You can change these settings again at a later time (see “Settings”).

 Risk of injury caused by hot surfaces.

The steam oven gets hot during operation.

For safety reasons, the steam oven may only be used when it has been fully installed.

The steam oven will switch on automatically when it is connected to the electricity supply.

Setting the language

- Select the language you want.
- Confirm with *OK*.

If you have accidentally selected a language that you don't understand, proceed as described in “Settings – Language ”.

Setting the location

- Select the required location.
- Confirm with *OK*.

Setting up Miele@home

Set up “Miele@home” appears in the display.

- To set up Miele@home immediately, select *Continue* and confirm with *OK*.
- To set it up at a later date, select *Skip* and confirm with *OK*.
See “Settings – Miele@home” for information on setting up at a later date.
- To set up Miele@home immediately, select the desired connection method.

You will then be guided by the display and the Miele App.

Setting the date

- Set the year, then the month, and finally the day.
- Confirm with *OK*.

Setting the time of day

- Set the time of day in hours and minutes.
- Confirm with *OK*.

Before using for the first time

Setting the water hardness level

Contact your local water supplier to find out your local water hardness range if necessary.

See the “Settings - Water hardness” for more information.

- Set the water hardness level for your area.
- Confirm with *OK*.

Completing the commissioning process

- Follow any further instructions in the display.

The appliance is now ready for use.



Cleaning for the first time

- Remove any protective foil and stickers, except the data plate, from the oven and accessories.

The appliance has undergone a function test in the factory. Residual water from this testing may have trickled back into the cabinet during transportation.

Cleaning the water container and condensate container

 Risk of injury caused by the control panel.
You could get caught in the panel as it opens or closes.
Do not touch the upper edge of the door when the panel is opening and closing.

- Switch the steam oven on using the On/Off  sensor.
- Select the  sensor to open the control panel.
- Remove the water container and condensate container. Remove the water container and condensate container by pushing them upwards slightly as you take them out of the appliance.
- Rinse the water container and condensate container by hand or in the dishwasher.

Before using for the first time

Cleaning the accessories/oven compartment

- Take all accessories out of the oven compartment.
- Wash the cooking containers by hand using hot water and a little washing-up liquid or in the dishwasher.

The universal tray and combi rack surfaces are treated with PerfectClean enamel and must **only** be washed by hand. See "Cleaning and care - PerfectClean".

- Clean the universal tray and combi rack with a solution of warm water and a little washing-up liquid applied with a soft sponge.

The interior of the steam oven has been treated at the factory with a conditioning agent.

- To remove this, clean the oven interior with a mild solution of washing-up liquid and warm water applied with a soft sponge, and then dry thoroughly with a soft cloth.

Setting the correct boiling point for water

Before cooking food for the first time, you must adjust the boiling temperature of the water, which varies depending on the altitude of where the steam oven is located. This procedure also flushes out the waterways.

This procedure **must** be carried out to ensure efficient functioning of your appliance.

Distilled or carbonated water or other liquids could damage the steam oven.

Only use cold, fresh tap water (below 20 °C).

- Remove the water container and fill it up to the maximum marker.
- Push the water container into the appliance.
- Run the steam oven for 15 minutes using the Steam cooking  function (100 °C). Proceed as described in "Operation".

Setting the correct boiling point for water following a house move

If you move house, the boiling point for the water in the steam oven will need to be reset for the new altitude if this differs from the old one by 300 m or more. To do this, descale the appliance (see "Cleaning and care - Maintenance").

Before using for the first time

Heating up the appliance

- Take all accessories out of the oven compartment if applicable.
- To remove the grease from the ring heating element, heat the steam oven up at 200 °C using the Fan Plus  function for 30 minutes. Proceed as described in “Operation”.

 Risk of injury caused by hot surfaces.





The steam oven gets hot during operation. You could burn yourself on the heating elements, oven compartment or shelf runners.

Use oven gloves when working in the hot oven compartment.

The heating element will give off a slight smell when it is heated up for the first time. The smell and any vapours given off will dissipate after a while and do not indicate a faulty connection or appliance.

It is important to ensure that the kitchen is well ventilated during this operation.

Settings overview

Menu option	Available settings
Language 	... deutsch english ... Location
Time	Show On* Off Night dimming Clock format 12 h 24 h* Set
Date	
Lighting	On "On" for 15 seconds* Off
Display	Brightness  * QuickTouch On Off*
Volume	Buzzer tones Melodies  * Solo tone  * Keypad tone  * Welcome melody On* Off
Units	Weight g* lb/oz lb Temperature °C* °F
Keeping warm	On Off*
Steam reduction	On* Off
Recommended temperatures	
Booster	On* Off
Water hardness	1° dH ... 15° dH* ... 70° dH



* Factory settings

Settings

Menu option	Available settings
Automatic rinsing	On* Off
Safety	Sensor lock On Off* System lock  On Off*
Miele@home	Activate Deactivate Connection status Set up again Reset Set up
Remote control	On* Off
RemoteUpdate	On* Off
Software version	
Showroom programme	Demo mode On Off*
Factory default	Appliance settings User programmes Recommended temperatures

* Factory settings

Opening the “Settings” menu

In the Other  | Settings  menu, you can personalise your steam oven by adapting the factory default settings to suit your requirements.

- Select Other .
- Select Settings .
- Select the desired setting.



You can check settings or change them.

Settings cannot be altered while a cooking programme is in progress.

Language

You can set your language and location.

After selecting and confirming your choice, the language you have selected will appear in the display.

Useful tip: If you have selected the wrong language by mistake, select the  sensor. Follow the  symbol to get back to the Language  sub-menu.

Time

Show

Select how you want the time of day to appear in the display when the steam oven is switched off:

- On
The time is always visible in the display.
If you also select the Display | QuickTouch | On setting, all sensors react to touch as normal.
If you also select the Display | QuickTouch | Off setting, the steam oven has to be switched on before it can be used.
- Off
The display is dark to save energy.
The steam oven has to be switched on before you can use it.
- Night dimming
To save energy, the time is only visible in the display between 5:00 am and 11:00 pm. The display remains dark at all other times.

Clock format

The time of day can be displayed in the 24 or 12-hour format (24 h or 12 h).

Settings

Set

Set the hours and then the minutes.



If there is a power cut, the current time of day will reappear once power has been restored. The time of day is saved for approx. 150 hours.

If the steam oven has been connected to a Wi-Fi network and signed into the Miele App, the time will be synchronised based on the location setting in the Miele App.

Date

Set the date.



Lighting

- On
The oven interior lighting is switched on during the entire cooking period.
- "On" for 15 seconds
The oven interior lighting switches off 15 seconds after a cooking programme has begun. Press the  sensor to switch the oven interior lighting on again for 15 seconds.
- Off
The oven interior lighting is switched off. Press the  sensor to switch on the oven interior lighting for 15 seconds.

Display

Brightness

The display brightness is represented by a segment bar.

- 
Maximum brightness
- 
Minimum brightness

QuickTouch

Select how the sensors should respond when the steam oven is switched off:

- On
If you have also selected the Time | Show | On or Night dimming setting, the sensors will also respond when the steam oven is switched off.
- Off
Independently of the Time | Show setting, the sensors only respond when the steam oven is switched on, as well as for a certain amount of time after switching it off.

Volume

Buzzer tones

If buzzers are switched on, a buzzer will sound when the set temperature is reached and at the end of a set time.

Melodies

At the end of a process, a melody will sound several times at intervals.

The volume of the melody is represented by a segment bar.

- ■■■■■■■■
Maximum volume

- □□□□□□
Melody is switched off

Solo tone

At the end of a process, a continuous tone will sound for a period of time.

The pitch of this continuous tone is represented by a segment bar.

- ■■■■■■■■■■■■■■■■■■■■
Highest pitch

- □□□□□□□□□□□□□□
Lowest pitch

Keypad tone

The volume of the tone that sounds each time you touch a sensor is represented by a segment bar.

- ■■■■■■■■
Maximum volume

- □□□□□□
Keypad tone is switched off

Welcome melody

The melody that sounds when you touch the On/Off  sensor can be switched on or off.

Units

Weight

For Automatic programmes, you can set the weight of food in grams (g), pounds/ounces (lb/oz) or pounds (lb).

Temperature

You can set the temperature in degrees Celsius (°C) or degrees Fahrenheit (°F).

Settings

Keeping warm

Using the Keeping warm function, you can keep food warm at the end of a steam cooking programme. Food is kept warm at a preset temperature for a maximum of 15 minutes. You can cancel the keeping warm process by opening the door.

Please note that delicate food, especially fish, can continue cooking whilst being kept warm.

- On
The Keeping warm function is switched on. If a temperature of at least 80 °C is selected, this function will switch on after approx. 5 minutes. The food is kept warm using a temperature of 70 °C.
- Off
The Keeping warm function is switched off.

Steam reduction

The Steam reduction function stops excessive steam escaping when the door is opened.

- On
The steam reduction function will switch on automatically at the end of a cooking programme which uses a temperature of over approx. 80 °C (steam cooking) or 80–100 °C and 100% moisture (Combi mode). Steam reduction appears in the display.
- Off
If steam reduction is switched off, the Keeping warm function is also automatically switched off. When steam reduction is switched off, a large amount of steam will escape when the door is opened.

Recommended temperatures

If you frequently cook with different temperatures, it makes sense to change the recommended temperatures.

After selecting this option, a list of oven functions will appear in the display.

- Select the function you want.

The recommended temperature will appear together with the range within which it can be changed.

- Change the recommended temperature.
- Confirm with *OK*.

Booster

The **Booster** function is used to quickly pre-heat the oven.

- On
The **Booster** function is automatically switched on during the heating-up phase of a cooking programme. The top heat/grill element, ring heating element and hot air fan pre-heat the oven compartment to the set temperature at the same time.
- Off
The **Booster** function is switched off during the heating-up phase of a cooking programme. Only the heating elements for the selected oven function are used to pre-heat the oven compartment.

Settings

Water hardness

To ensure that the steam oven works correctly and to ensure that descaling is carried out at the correct interval, it must be set to the local water hardness level. The harder the water is, the more frequently the steam oven needs to be descaled. Contact your local water supplier to find out your local water hardness range if necessary.

If you are using bottled drinking water, e.g. mineral water, use non-carbonated water. Select settings according to the calcium content. The calcium content is given on the label of the bottle in mg/l Ca²⁺ or ppm (mg Ca²⁺/l).

The degree of hardness can be set between 0.2 mmol/l (1 °dH) and 12.5 mmol/l (70 °dH). The hardness level is set to 2.7 mmol/l (15 °dH) at the factory.

- Set the water hardness level for your area.
- Confirm with OK.

Water hardness		Calcium content mg/l Ca ²⁺ or ppm (mg Ca ²⁺ /l)	Setting
°dH	mmol/l		
1	0.2	7	1
2	0.4	14	2
3	0.5	21	3
4	0.7	29	4
5	0.9	36	5
6	1.1	43	6
7	1.3	50	7
8	1.4	57	8
9	1.6	64	9

Water hardness		Calcium content mg/l Ca ²⁺ or ppm (mg Ca ²⁺ /l)	Setting
°dH	mmol/l		
10	1.9	71	10
11	2.0	79	11
12	2.2	86	12
13	2.3	93	13
14	2.5	100	14
15	2.7	107	15
16	2.9	114	16
17	3.1	121	17
18	3.2	129	18
19	3.4	136	19
20	3.6	143	20
21	3.8	150	21
22	4.0	157	22
23	4.1	164	23
24	4.3	171	24
25	4.5	179	25
26	4.7	186	26
27	4.9	193	27
28	5.0	200	28
29	5.2	207	29
30	5.4	214	30
31	5.6	221	31
32	5.8	229	32
33	5.9	236	33
34	6.1	243	34
35	6.3	250	35
36	6.5	257	36
37-45	6.6-8.0	258-321	37-45
46-60	8.2-10.7	322-429	46-60
61-70	10.9-12.5	430-500	61-70

Automatic rinsing

Following a cooking programme with steam, *Appliance rinsing* will appear in the display after the steam oven has been switched off.

This process flushes any remaining food deposits out of the system.

You can activate or deactivate the automatic rinsing process.

Safety

Sensor lock

The sensor lock prevents the cooking programme being switched off by mistake or settings being changed. Apart from the On/Off  sensor, the activated sensor lock prevents the sensors and fields in the display from working a few seconds after a programme has been started.

- On
The sensor lock is switched on. Touch the *OK* sensor for at least 6 seconds to deactivate the sensor lock for a short period of time.
- Off
The sensor lock is deactivated. All sensor controls react to touch as normal.

If you want to switch off the appliance with the sensor lock activated, touch the On/Off  sensor until the appliance switches off.

System lock

The system lock prevents the appliance being switched on by mistake.

The minute minder and the MobileStart function can still be used when the system lock is active.

The system lock will remain activated even after a power failure.

- On
The system lock is switched on. Before you can use the steam oven, touch the *OK* sensor for at least 6 seconds.
- Off
The system lock is deactivated. You can use the steam oven as normal.

Settings

Miele@home

The steam oven is a Miele@home compatible appliance. Your steam oven is fitted ex-works with a Wi-Fi communication module and is suitable for wireless communication.

There are a number of ways of connecting your steam oven to your Wi-Fi network: We recommend connecting your steam oven to your Wi-Fi network with the help of the Miele App or via WPS.

- Activate
This setting is only visible if Miele@home is deactivated. The Wi-Fi function is reactivated.
- Deactivate
This setting is only visible if Miele@home is activated. Miele@home remains set up, the Wi-Fi function is switched off.
- Connection status
This setting is only visible if Miele@home is activated. The display shows information such as the Wi-Fi reception quality, network name and IP address.
- Set up again
This setting is only visible if a Wi-Fi network has already been set up. Reset the network settings and immediately set up a new network connection.
- Reset
This setting is only visible if a Wi-Fi network has already been set up. The Wi-Fi function is deactivated and the Wi-Fi network will be reset to the factory default. You must set up a new connection to the Wi-Fi network to be able to use Miele@home. The network settings should be reset whenever the steam oven is being disposed of or sold, or if a used steam oven is being put into operation. This is the only way to ensure that all personal data has been removed and, in the case of the latter, the previous owner will no longer be able to access the steam oven.
- Set up
This setting is only visible if no connection to the Wi-Fi network has been set up yet. You must set up a new connection to the Wi-Fi network to be able to use Miele@home.

Remote control

If you have installed the Miele App on your mobile device, have access to the Miele@home system and have activated the remote control function (On), you can use the MobileStart function to retrieve information on steam oven cooking programmes currently in progress or to end a programme in progress.

Activating MobileStart

- Select the  sensor to activate MobileStart.

The  sensor lights up. You can operate your steam oven remotely with the Miele App.

Directly operating the steam oven takes priority over operating it via the remote control function on the App.

You can use MobileStart as long as the  sensor is lit up.

RemoteUpdate

The RemoteUpdate menu option is only displayed and can only be selected if the requirements for using Miele@home have been met (see “Before using for the first time – Miele@home” or “Settings”).

The RemoteUpdate function is used for updating the software in your steam oven. If an update is available for your steam oven, it will automatically download it. Updates will not be installed automatically. They must be initiated manually.

If you do not install an update, you can continue to use your steam oven as usual. However, Miele recommends installing updates.

Switching on/Switching off

RemoteUpdate is switched on as standard. Available updates will be downloaded automatically and will only be installed if you initiate it.

Switch off RemoteUpdate if you do not wish any updates to be downloaded.

Settings

Running a RemoteUpdate

Information about the content and scope of an update is provided in the Miele App.

A message will appear in your steam oven display if a software update is available.

You can install the update immediately or postpone this until later. When the steam oven is switched on again, you will be reminded about the update.

Switch RemoteUpdate off if you do not wish to install updates.

The update can take several minutes.

Please note the following information about the RemoteUpdate function:

- You will only receive a message when an update is available.
- Once an update has been installed, it cannot be undone.
- Do not switch the steam oven off during the update. Otherwise, the update will be aborted and will not be installed.
- Some software updates can only be carried out by a Miele service technician.

Software version

The software version menu option is for use by Miele service technicians. You do not need this information for domestic use.

Showroom programme

This function enables the steam oven to be demonstrated in showrooms without heating up. Do not activate this setting for domestic use.

Demo mode

If you have activated Demo mode, Demo mode is activated. The appliance will not heat up will appear when you switch the steam oven on.

- On
Touch the OK sensor for at least 4 seconds to activate Demo mode.
- Off
Touch the OK sensor for at least 4 seconds to deactivate Demo mode. You can use the steam oven as normal.

Factory default

- Appliance settings
Any settings that have been altered will be reset to the factory default settings.
- User programmes
All User programmes will be deleted.
- Recommended temperatures
Any recommended temperatures that have been changed will be reset to the factory default settings.

Using the Minute minder function

The  minute minder can be used to time other activities in the kitchen, e.g. boiling eggs on the cooktop.

The minute minder can also be used at the same time as a cooking programme for which the cooking duration start and finish times have been set (e.g. as a reminder to stir the food or add seasoning, etc.).

- The maximum minute minder time that can be set is 59 minutes and 59 seconds.

Setting the minute minder

If you have selected the Display | QuickTouch | Off setting, you will need to switch the steam oven on before setting the minute minder. The minute minder can then be seen counting down in the display when the steam oven is switched off.

Example: You want to boil some eggs and set a minute minder time of 6 minutes and 20 seconds.

- Select the  sensor.
- Select Minute minder if a cooking programme is in progress at the same time.

The prompt Set 00:00 min will appear.

- Using the navigation area, set 06:20.
- Confirm with *OK*.

The minute minder duration is now saved.

When the steam oven is switched off, the minute minder time will count down in the display and  will appear instead of the time of day.

If you are cooking at the same time,  and the minute minder time will appear at the bottom of the display.

If you are in a menu, the minute minder will count down in the background.

At the end of the minute minder time  will flash, the time will start counting up and a buzzer will sound.

- Select the  sensor.
- If required, confirm with *OK*.

The buzzer will stop and the symbols in the display will go out.

Changing the time set for the minute minder

- Select the  sensor.
- Select Minute minder if a cooking programme is in progress at the same time.
- Select Change.
- Confirm with *OK*.

The minute minder time selected appears.

- Change the time set for the minute minder.
- Confirm with *OK*.

The altered minute minder time is now saved.











Minute minder

Cancelling the minute minder



- Select the 🕒 sensor.
- Select Minute minder if a cooking programme is in progress at the same time.
- Select Delete.
- Confirm with *OK*.

The minute minder is now cancelled.

Main and sub-menus

Menu	Recommended value	Range
Oven functions		
Steam cooking 	100 °C	40–100 °C
Fan Plus 	160 °C	30–225 °C
Combi mode 		
Combi Fan Plus	170 °C	30–225 °C
Combi Conventional	180 °C	30–225 °C
Combi Grill	Setting 3	Setting 1–3
Sous-vide 	65 °C	45–90 °C
User programmes 		
Reheat 	130 °C	120–140 °C
Defrost 	60 °C	50–60 °C
Descalc 		
Automatic programmes 		
Other 		
Conventional Heat	180 °C	30–225 °C
Intensive Bake	180 °C	50–225 °C
Bottom Heat	190 °C	100–200 °C
Top Heat	190 °C	100–225 °C
Full Grill	Setting 3	Setting 1–3
Economy Grill	Setting 3	Setting 1–3
Fan Grill	200 °C	50–225 °C
Cake Plus	160 °C	30–225 °C
Eco Fan Heat	180 °C	30–225 °C
Eco Steam cooking	100 °C	40–100 °C

Main and sub-menus

Menu	Recommended value	Range
Other 		
Special applications		
Mix & Match		
Menu cooking	–	–
Blanch	–	–
Bottling	90 °C	80–100 °C
Drying	50 °C	30–70 °C
Prove yeast dough	–	–
Disinfect items	–	–
Sabbath programme	180 °C	50–225 °C
Heat crockery	50 °C	50–80 °C
Keeping warm	65 °C	40–100 °C
Maintenance		
Soak		
Drying		
Rinse		
Settings 		

Cooking programmes

- Remove any accessories from the oven that are not required for a cooking process.
- In general, if a range of temperatures is given in a recipe or chart, it is best to select the lower temperature and to check the food after the shortest duration.
- Pre-heat the oven only if instructed to do so in the recipe or the cooking chart.
- Avoid opening the door during a cooking process.
- Dark, matt tins are best for baking. They absorb the heat more effectively and transmit it to the mixture more quickly. Shiny materials such as stainless steel or aluminium reflect the heat, preventing it from reaching the food efficiently. Do not cover the oven floor or the rack with heat-reflective aluminium foil.
- Monitor cooking durations to avoid wasting energy when cooking food. Set the cooking duration, or use a food probe if you have one.
- The Fan Plus  function can be used for cooking many types of food. Because the fan distributes the heat in the oven compartment straight away, it allows you to use a lower temperature than you would with Conventional Heat. It also enables you to cook on several shelf levels at the same time.
- Fan Grill is the best function for grilled dishes. With Fan Grill you can use lower temperatures than with other grill functions which use the maximum temperature setting.
- The Eco Fan Heat function ensures energy-efficient cooking thanks to optimal utilisation of heat. Use this function for preparing small quantities such as frozen pizza or cookie cutter cookies. Do not open the door during the cooking programme.
- You can use the Eco Steam cooking function to save energy during steam cooking. This function is suitable mainly for cooking fish and vegetables.
- Whenever possible, you should cook several dishes at the same time. Place them next to each other in the oven or on different shelf levels.
- Dishes which you are unable to prepare at the same time should, if possible, be cooked one after the other in order to make use of existing heat in the oven.

Energy saving tips

Customising settings

- Select the setting **Display | QuickTouch | Off** for the control elements in order to reduce energy consumption.
- Select the **Lighting | Off** or **“On” for 15 seconds** setting for the oven interior lighting. The oven interior lighting can be switched on again at any time by touching the  sensor.

Energy saving mode

The steam oven will switch itself off automatically to save energy if a programme is not being run and controls have not been operated. The time of day will appear in the display or the display will remain dark (see “Settings – Time”).

Malfunction due to missing floor filter.

If the floor filter is missing, food deposits can get into the drain. The water cannot be pumped away.

Before each cooking programme, check that the filter in the floor of the oven compartment is correctly fitted.

- Switch the steam oven on.

The main menu will appear.

- If you want to cook using a steam function or with bursts of steam, fill the water container and fit it back in place.

Distilled or carbonated water or other liquids could damage the steam oven.

Only use cold, fresh tap water (below 20 °C).

- Place the food in the oven.
- Select the function you want.

The function will appear in the display. Depending on which function you have selected, the recommended values for temperature and moisture (if applicable) will appear one after the other.

- Change the recommended temperature if necessary.
- Confirm with *OK*.

Otherwise the recommended temperature will be accepted within a few seconds. You can change the temperature subsequently via the arrow sensors.

- Change the moisture setting if necessary.

- Confirm with *OK*.

The required and the actual temperature are displayed and the heating-up phase will begin.

You will see the temperature rising in the display. A buzzer will sound when the selected temperature is reached for the first time.

- After cooking, select the sensor for the selected function to end the cooking programme.



Risk of injury due to hot steam.

When using a cooking programme involving steam, a lot of hot steam can escape if the door is opened.

The steam can cause burns.

Step back and wait until the hot steam has dissipated.

- Take the food out of the oven.

Operation

Cleaning the steam oven

- Remove the water container and condensate container and empty them as required.
- Switch the steam oven off.

Appliance rinsing appears after a cooking programme involving steam.

- Follow the instructions in the display.

The rinsing process should be carried out every time to flush any remaining food deposits out of the system.

- After each use, clean and dry the whole appliance as described in “Cleaning and care”.
- Leave the appliance door open until the oven interior is completely dry.

Refilling the water

If water needs replenishing during the cooking programme, a tone will sound and the display will prompt you to refill the container with fresh water.

- Remove the water container and fill it with fresh tap water.
- Push the water container into the appliance.
- Close the control panel.

The cooking programme will continue.

Changing values and settings for a cooking programme

Depending on the function, as soon as a cooking programme is in progress, you can use the ↵ sensor to change the values or settings for this programme.

- Select the ↵ sensor.

Depending on the function, the following settings appear:



- Temperature
- Moisture
- Duration
- Booster
- Pre-heat
- Crisp function

Changing values and settings

- Select the desired value or setting and confirm with *OK*.
- Change the value or setting and confirm with *OK*.

The cooking programme will continue with the new values and settings.

Changing the temperature

You can permanently reset the recommended temperature to suit your cooking preferences by selecting Other  | Settings  | Recommended temperatures.

- Select the  sensor.
- Select Temperature and confirm with *OK*.
- Change the target temperature via the navigation area.
- Confirm with *OK*.

The cooking programme will restart with the new target temperature.

Changing the moisture level

- Select the  sensor.
- Select Moisture and confirm with *OK*.
- Change the moisture level.
- Confirm with *OK*.

The programme will continue to run at the new moisture level.

Setting cooking durations

Cooking results can be adversely affected if there is a long delay between the food being placed in the oven and the start of cooking. Fresh food can change colour and even spoil.

When baking, the cake mixture or dough can dry out, and the raising agents can lose their effectiveness.

Select as short a time as possible until the start of the cooking process.

Example: You have placed the food in the oven compartment, selected a function and the required settings such as the temperature.



By entering Duration, Finish at or Start at via the  sensor, you can automatically switch the cooking programme off, or on and off.

- Duration
Enter the required cooking duration for the food. The heating will switch off automatically once this duration has elapsed. The maximum cooking duration that can be set depends on the function that you have selected.
- Finish at
Specify when you want the cooking programme to finish. The oven heating will switch off automatically at the time you have set.

Operation

- Start at

This function will only appear in the menu if you have set a **Duration** or **Finish at time**. With **Start at**, you have to specify when you want the cooking programme to start. The oven heating will switch on automatically at the time you have set.



- Select the  sensor.
- Set the required times.
- Confirm with **OK**.
- Touch the  sensor to return to the menu of the selected function.

When cooking with steam, the cooking duration does not begin until the set required temperature is reached.

The steam reduction function will switch on at the end of a cooking programme which used a temperature of over approx. 80 °C (steam cooking) or 80–100 °C and 100% moisture (Combi mode).

- Wait until **Steam reduction** goes out in the display before opening the door and removing the food from the oven.

Changing the set cooking durations

- Select the  sensor.
- Select the time you want.
- Confirm with **OK**.
- Select **Change**, if required.
- Change the set time.
- Confirm with **OK**.
- Touch the  sensor to return to the menu of the selected function.

These settings will be deleted in the event of a power failure.

Useful tip: You can also adjust the cooking duration directly via the navigation area.

Deleting the set cooking durations

In functions and applications where it is always necessary to set a cooking duration, you can only delete the set times for **Finish at** and **Start at**.

- Select the ⌚ sensor.
- Select the time you want.
- Confirm with *OK*.
- Select *Delete*.
- Confirm with *OK*.
- Touch the ↩ sensor to return to the menu of the selected function.

If you delete **Duration**, the set times for **Finish at** and **Start at** are also deleted.

If you delete **Finish at** or **Start at**, the cooking programme will start using the cooking duration set.

Useful tip: You can also delete the cooking duration directly via the navigation area.

Cancelling cooking

You can cancel a cooking programme using the function sensor that lights up orange or using the ↩ sensor.

The oven compartment heating and lighting will then switch off. Any cooking durations set will be deleted.

Touch the function sensor to return to the main menu.

Cancelling a cooking programme without a set cooking duration

- Touch the sensor for the selected function.

The main menu will appear.

- **Or:** select the ↩ sensor.
- Select *Cancel process*.
- Confirm with *OK*.

Cancelling a cooking programme with a set cooking duration

- Touch the sensor for the selected function.

Cancel process? appears in the display.

- Select *Yes*.
- Confirm with *OK*.
- **Or:** select the ↩ sensor.
- Select *Cancel process*.
- Confirm with *OK*.
- Select *Yes*.
- Confirm with *OK*.

Operation

Interrupting a cooking programme

A cooking programme is interrupted as soon as the door is opened. The oven heating switches off.

The set cooking duration is saved when cooking with steam as well as for programmes and applications with pure steam operation.

 Risk of injury due to hot steam. When using a cooking programme involving steam, a lot of hot steam can escape if the door is opened. The steam can cause burns. Step back and wait until the hot steam has dissipated.

 Risk of injury caused by hot surfaces and food. The steam oven gets hot during operation. You could burn yourself on the heating elements, oven compartment, shelf runners, accessories or food. Wear oven gloves when placing food in the oven or removing it, and when adjusting oven shelves etc. in a hot oven. When placing cooking containers in the oven or removing them, make sure that the hot food does not spill.

The cooking programme will resume when the door is closed.

The steam oven will heat up again and the display will show the temperature in the cooking compartment as it rises. When cooking with steam as well as for programmes and applications with pure steam operation, the remaining time only continues to count down once the set temperature has been reached.

In programmes using 100% moisture and temperatures up to 100 °C: the cooking programme will finish early if the door is opened in the last minute of cooking (55 seconds remaining).

Pre-heating the oven

The **Booster** function is used to quickly pre-heat the oven compartment in some functions.



The **Pre-heat** function can be used with any oven function (except **Eco Fan Heat**) and has to be switched on separately for each cooking programme.

If you have set a cooking duration, it will only start to count down after the heating-up phase.

It is only necessary to pre-heat the oven in a few instances.

- Pre-heat the oven compartment when cooking the following food:
 - Cakes and pastries with a short cooking duration (up to approx. 30 minutes) as well as delicate items (e.g. sponge) with the **Conventional Heat** function

Booster

The **Booster** function is switched on as the factory default setting for the following functions (Other  | Settings  | **Booster** | On):

- Fan Plus 
- Conventional Heat

If you set a temperature above 100 °C and the **Booster** function is switched on, a rapid heating-up phase heats the oven compartment to the set temperature. The top heat/grill element and the ring heating element come on together with the hot air fan.

Delicate items (e.g. sponge or biscuits) will brown too quickly on the top if the **Booster** function is used.

Switch off the **Booster** function for these items.

Switching Booster on or off for a cooking programme

If you have selected the **Booster** | On setting, you can switch off the function separately for a cooking programme.

On the other hand, you can also switch on the function separately for a cooking programme if you have selected the **Booster** | Off setting.

Example: You have selected a function and the required settings such as the temperature.

You want to switch off the **Booster** function for this cooking programme.

- Select the  sensor.
- Select **Booster** | Off.
- Confirm with **OK**.

The **Booster** function is switched off during the heating-up phase. Only the heating elements for the selected oven function are used to pre-heat the oven compartment.

Operation

Pre-heat

You can place most dishes in the cold oven compartment to make use of the heat produced during the heating-up phase.

If you have set a cooking duration, it will only start to count down when the target temperature is reached and you have placed the food in the oven.

Start the cooking programme immediately without delaying the start time.

Switching on the Pre-heat function

The Pre-heat function has to be switched on separately for each cooking programme.

Example: You have selected a function and the required settings such as the temperature.

You want to switch on the Pre-heat function for this cooking programme.

- Select the ↩ sensor.
- Select Pre-heat | On.
- Confirm with *OK*.

The following message is displayed with a time: Place food in oven at The oven compartment is heated to the set temperature.

- As soon as you are prompted to do so, place the food in the oven compartment.
- Confirm with *OK*.

Crisp function

The Crisp function (moisture reduction) allows moisture to be removed from the oven as required during the entire cooking process or at times during the process.

It is a good idea to use this function when cooking items which have a moist topping, e.g. quiche, pizza, tray bakes with fresh fruit toppings or muffins.

Poultry in particular gets a good crisp skin with this function.

The Crisp function can be used in the following functions:

- Fan Plus 
- Conventional Heat
- Intensive Bake
- Bottom Heat
- Top Heat
- Fan Grill
- Cake Plus

Switching on the Crisp function

The Crisp function has to be switched on separately for each cooking programme.

Example: You have selected a function and the required settings such as the temperature.

You want to switch on the Crisp function for this cooking programme.

- Select the  sensor.
- Select Crisp function | On.
- Confirm with *OK*.

The Crisp function is switched on.

The Crisp function can be switched off again at any time via the  sensor.

Injecting bursts of steam

You can release bursts of steam during the cooking process in all oven functions (except Eco Fan Heat). The number of bursts of steam is unlimited.

You can release a burst of steam as soon as *Burst of steam* is highlighted in the display.

Please wait until the heating-up phase is completed to allow the steam to be distributed evenly in the warm air in the oven.

- Select *OK*.

The burst of steam will be released.  appears in the display and *Burst of steam* goes out. This will take approximately 1 minute.

- Proceed as described to release further bursts of steam once *Burst of steam* appears in the display again.

General notes

This section contains general information. You will find more detailed information about particular foods and how to cook them in the other sections.

The advantages of cooking with steam

Almost all vitamins and minerals are retained as the food is not immersed in water.

Cooking with steam also retains the true taste of the food better than conventional cooking. We therefore recommend seasoning the food after it has been cooked. Food also retains its fresh, original colour.

Suitable containers

Cooking containers

This steam oven is supplied with stainless steel cooking containers. Other containers, in a variety of sizes, both perforated and solid, are available as optional extras (see “Optional accessories”). This enables you to choose the most suitable container for the meal you are preparing.

Use perforated cooking containers for **steam cooking** if possible. The steam can reach the food from all sides and the food is cooked evenly.

Your own containers

You can also use your own containers. However, please note the following:

- Containers must be suitable for use in an oven and able to withstand steam. With plastic containers, please check with the manufacturer that they are suitable for use in a steam combination oven.
- Thick-sided containers made from porcelain, ceramic, or stoneware are not very suitable for using with steam. Due to their thick sides, they do not conduct heat well and as a result cooking durations will be considerably longer than those given in the charts.
- Place the containers on the rack or on a suitable tray. Depending on the size of the container, you can also place the rack on the floor of the oven compartment with the rack surface facing up and the cooking container on top. You can also take the shelf runners out to make more room (see “Cleaning and care - Cleaning the shelf runners”).
- Ensure that there is a gap between the upper rim of the container and the top of the cooking compartment to allow sufficient steam into the container.

Shelf level

You can select any shelf level. You can also cook on several levels at the same time. This will not alter the cooking duration.

When cooking with more than one deep cooking container at the same time, offset them to allow steam to circulate properly. If possible, leave a shelf level between the containers.

Always insert cooking containers, the rack and the tray between the rails of the shelf runners so that they cannot tip.

Frozen

The heating-up phase for frozen food is longer than for fresh food. The greater the quantity of frozen food, the longer the heating-up phase.

Temperature

During steam cooking, the temperature does not exceed 100 °C. Almost all foods can be cooked at this temperature. Some types of food, such as berries, need to be cooked at lower temperatures to prevent them from bursting. See the relevant sections in these operating instructions for more details.

Duration

During steam cooking, the cooking duration does not begin until the set temperature is reached.

In general, the cooking durations for cooking with steam are the same as for cooking food in a saucepan. More information about any factors which may affect the cooking duration is given in the relevant sections.

The quantity of food does not affect the cooking duration. 1 kg of potatoes will take the same time to cook as 500 g of potatoes.

Cooking with liquid

When cooking with liquid, only fill the cooking container $\frac{2}{3}$ full to prevent the liquid spilling when the cooking container is removed from the oven.

Your own recipes - steam cooking

Food and recipes which are prepared in a pot or a pan can also be cooked in the steam oven. The cooking times in the steam oven will be the same. Please note that food will not be brown or crisp when cooking with steam.

General notes

Universal tray and combi rack

Use the universal tray with the combi rack placed on top of it, e.g. for roasting and grilling. During roasting, you can use the meat juices collected in the tray to make a gravy or sauce.

If you are using the universal tray with the combi rack on top, insert the universal tray between the rails of a shelf level and the combi rack will automatically sit on top. When removing them from the oven, pull both out together.

Non-tip safety notches

The combi rack and universal tray have non-tip safety notches which prevent them being pulled right out when they only need to be partially pulled out. The tray and rack can then only be taken out of the oven by raising them upwards and then pulling them out.

Eco Steam cooking

You can use the Eco Steam cooking function to save energy during steam cooking. This function is suitable mainly for cooking fish and vegetables.

We recommend using the cooking durations and temperatures given in the chart under “Steam cooking”.

You can cook for longer if necessary.

When cooking starchy foods such as potatoes, rice and pasta, the best function to use is Steam cooking .

Setting

Other  | Eco Steam cooking

Notes on the cooking charts

Follow the instructions on cooking durations, temperatures and cooking notes.

Selecting the cooking duration

The cooking durations given are guidelines only.

- We recommend selecting the shorter duration initially. You can cook for longer if necessary.

Steam cooking

Vegetables

Fresh

Prepare fresh vegetables in the usual way, i.e. wash, clean and cut them up.

Frozen food

Frozen vegetables do not need to be defrosted beforehand. Exception: the vegetables have been frozen together in a block.

Frozen and fresh vegetables which take the same length of time to cook can be cooked together.

If vegetables have frozen together in clumps, break these up before cooking with steam. Follow the manufacturer's instructions on the packaging regarding cooking duration.

Cooking containers

Food such as peas or asparagus spears, which have little or no space between them, will take longer to cook because the steam has less space to work in. For an even result, it is best to use a shallow container for these types of food, and only fill it about 3 - 5 cm deep. When cooking large quantities, divide the food between 2 or 3 shallow containers rather than using one deep one.

Different types of vegetables which take the same length of time to cook can be cooked together in one cooking container.

Use solid containers for vegetables which are cooked in liquid, e.g. cabbage.

Shelf level

When cooking vegetables with a distinctive colour (e.g. beetroot) in a perforated container at the same time as cooking other foods in other containers, place the solid tray directly underneath the perforated container to catch any drips and therefore avoid any colour transfer.

Duration

The cooking duration depends on the size of the food and how well cooked you want it, just as it does with conventional cooking methods.

Example:

Firm potatoes, cut into quarters:
approx. 12 minutes

Firm potatoes, cut in half:
approx. 17 minutes

Settings

Automatic programmes  |
Vegetables | ... |

or

Steam cooking 
Temperature: 100 °C
Duration: see chart

Steam cooking

Vegetables	 [min.]
Artichokes	32–38
Cauliflower, whole	27–28
Cauliflower, florets	8
Beans, green	6–8
Broccoli, florets	2–4
Chantenay carrots, whole	7–8
Chantenay carrots, halved	5–6
Chantenay carrots, chopped	4
Chicory, halved	4–5
Chinese cabbage, chopped	3
Peas	2
Fennel, halved	10–12
Fennel, sliced	4–5
Kale, chopped	23–26
Firm potatoes, peeled whole halved quartered	20–25 15–20 10–15
Fairly firm potatoes, peeled whole halved quartered	23–28 18–23 14–18
Soft potatoes, peeled whole halved quartered	25–30 20–25 15–20
Kohlrabi, cut into batons	6–7
Pumpkin, diced	4–8
Corn on the cob	10–15
Silverbeet, chopped	2–3

Steam cooking

Vegetables	🕒 [min.]
Capsicum, diced or sliced	2
New potatoes, firm	20–25
Mushrooms	2
Leeks, sliced	2–4
Leeks, halved lengthways	4–6
Romanesco, whole	22–25
Romanesco, florets	5–7
Brussels sprouts	10–12
Beetroot, whole	50–60
Red cabbage, chopped	15–20
Black salsify, whole	9–10
Celeriac, cut into batons	6–7
Asparagus, green	2–4
Asparagus, white	5–10
Carrots, chopped	6
Spinach	1–2
Spring cabbage, chopped	10–11
Celery, chopped	2–5
Turnips, chopped	6–7
White cabbage, chopped	12
Savoy cabbage, chopped	10–11
Zucchini, sliced	2–3
Sugar snap peas	2–3

🕒 Duration

Fish

Fresh

Prepare fresh fish in the usual way, i.e. clean, gut and fillet.

Frozen

Fish does not need to be fully defrosted before cooking. Defrost so that the surface is sufficiently thawed to take herbs and seasoning. Depending on the thickness of the fish, 2–5 minutes should be enough.

Preparation

Add some lemon or lime juice to fish before cooking. The citric acid helps the flesh stay firm.

It is not necessary to season fish when cooking with steam as this method retains the minerals which give the fish its unique flavour.

Cooking containers

If using a perforated container, grease it first or line it with baking paper.

Shelf level

When cooking fish in a perforated container at the same time as cooking other types of food in other containers, place the container with the fish directly above the universal tray to catch any liquid and so avoid any transfer of tastes to other food.

Temperature

85 °C – 90 °C

For gently cooking delicate types of fish, such as flounder.

100 °C

For cooking firmer types of fish, e.g. salmon.
Also for cooking fish in sauce or stock.

Duration

The cooking duration depends on the thickness and the texture of the fish, and not on the weight. The thicker the fish, the longer the cooking duration. A 3 cm thick piece of fish weighing 500 g will take longer to cook than a 2 cm thick piece of fish weighing 500 g.

The longer fish cooks, the firmer its flesh will become. Use the cooking durations given in the chart. If you find that the fish is not cooked sufficiently, only cook it for a few minutes more.

When cooking fish in sauce or stock, we recommend that you increase the cooking duration quoted by a few minutes.

Steam cooking

Useful tips

- Adding herbs and spices, such as dill, will help bring out the full flavour of the fish.
- Cook large fish in the swimming position. To help maintain the structure of the fish, place a small cup or similar upside down in the cooking container. Arrange the fish bellyside down over the cup.
- You can use any fish scraps, e.g. fish heads, bones, tails etc. to make a **fish stock**. Place the fish scraps together with some mixed vegetables in a solid cooking container and add cold water. Cook at 100 °C for 60 to 90 minutes. The longer the cooking duration, the stronger the stock.
- Preparing fish **au bleu** is a method involving cooking the fish in water with vinegar, at different proportions depending on the recipe. It is important not to damage the skin of the fish. This method is suitable for cooking trout, tench, eel and salmon.

Settings

Automatic programmes  | Fish | ... |

or

Steam cooking 

Temperature: see chart

Duration: see chart

Steam cooking

Fish	🌡️ [°C]	🕒 [min.]
Eel	100	5–7
Perch fillet	100	3–5
Bream/Snapper fillet	85	3–5
Trout, 250 g	90	8–12
Halibut/Trumpeter fillet	85	4–6
Blue eye trevalla/Ling fillet	100	6
Salmon fillet	100	4–8
Salmon steak	100	8–10
Australian salmon	90	8–10
Basa fillet	85	3
Rosefish fillet	100	6–8
Jackass morwong/Terakihi fillet	100	4–6
Flounder fillet	85	4–5
Stargazer/Monkfish fillet	85	6–8
Sole fillet	85	3
Turbot fillet	85	5–8
Tuna fillet	85	4–8

🌡️ Temperature, 🕒 duration

Steam cooking

Meat

Fresh

Prepare the meat in the usual way.

Frozen food

Meat should be thoroughly defrosted before cooking in the steam combination oven (see “Other applications” – “Defrost”).

Preparation

Meat which needs to be seared before being cooked, e.g. stewing steak, should be seared in a pan on the cooktop.

Duration

The cooking duration depends on the thickness and the texture of the meat, and not on the weight. The thicker the piece of meat, the longer the cooking duration. A piece of meat weighing 500 g which is 10 cm thick will take longer to cook than a piece of meat weighing 500 g which is 5 cm thick.

Useful tips

- To retain the **flavourings**, use a perforated cooking container. Place an unperforated cooking container underneath in order to collect the concentrate. You can use the concentrate to enhance your sauces or freeze it for later use.
- Boiling chicken, back or top rib and meat bones can be used to make **stock**. Place the meat together with the bones and some mixed vegetables in a cooking container and add cold water. The longer the cooking duration, the stronger the stock.

Settings

Automatic programmes  | Meat | ... |

or

Steam cooking 
Temperature: 100 °C
Duration: see chart

Steam cooking

Meat	🕒 [min.]
Beef shin, covered with water	110–120
Pork knuckle	135–140
Chicken breast fillet	8–10
Knuckle	105–115
Beef soup bones	110–120
Veal for stewing	3–4
Gammon steaks	6–8
Lamb stew	12–16
Turkey roulade	12–15
Turkey schnitzel	4–6
Rib of beef, covered with water	130–140
Beef stew	105–115
Boiling chicken, covered with water	80–90
Silverside	110–120

🕒 Duration

Steam cooking

Rice

Rice swells when cooked and needs to be cooked in liquid. The proportion of rice to liquid will vary depending on the type of rice.

The rice absorbs all the liquid during the cooking process so that none of the nutrients are lost.

Cooking container

Use a solid cooking container. Smaller quantities of rice (up to one cup, approx. 50-150 g) can alternatively be cooked in a suitable stainless steel bowl on the rack.

Preparation

Wash the rice before cooking. If you wash the rice in the cooking container, drain the water off carefully afterwards.

Useful tip: The required volume of liquid can be determined using scales or the "cup" method.

For the "cup method", first fill the desired amount of rice into a cup and then put the rice into the cooking container. Then measure the required volume of liquid (see chart) with the cup and add it to the rice.

Make sure that the rice is evenly distributed in the cooking container.

Settings



Automatic programmes  | Rice | ... |



or

Steam cooking 

Temperature: 100 °C

Duration: see chart

		 [min.]
Long-grain rice		
Basmati rice	1 : 1.5	15
Parboiled rice	1 : 1.5	23–25
Brown rice	1 : 1.5	26–29
Wild rice	1 : 1.5	26–29
Round grain rice		
Milk rice	1 : 2.5	30
Risotto	1 : 2.5	18–19

 :  Ratio of rice to liquid,  duration

Grains

Grains swell when cooked and need to be cooked in liquid. The proportion of grains to liquid depends on the type of grain.

Grains can be cooked whole or cracked.

Settings

Automatic programmes  | Grains | ... |

or

Steam cooking 

Temperature: 100 °C

Duration: see chart

	Ratio Grain : Liquid	 [min.]
Amaranth	1 : 1.5	15–17
Bulgur	1 : 1.5	9
Green spelt, whole	1 : 1	18–20
Green spelt, cracked	1 : 1	7
Oats, whole	1 : 1	18
Oats, cracked	1 : 1	7
Millet	1 : 1.5	10
Polenta	1 : 3	10
Quinoa	1 : 1.5	15
Rye, whole	1 : 1	35
Rye, cracked	1 : 1	10
Wheat, whole	1 : 1	30
Wheat, cracked	1 : 1	8

 Duration

Steam cooking

Pasta/Noodles

Dry pasta and noodles

Dry pasta and noodles swell when they are cooked and need to be cooked in liquid. The liquid must cover the pasta or noodles. Using hot liquid gives better results.

Increase the cooking time stated by the manufacturer by approx. 1/3.

Fresh food

Fresh pasta and noodles, such as those you can buy from the supermarket chilled counter, do not need to absorb water. Cook in a greased, perforated container.

Separate any pieces of pasta or noodles which have stuck together and spread them out in the cooking container.

Settings

Automatic programmes  | Pasta | ... |

or

Steam cooking 

Temperature: 100 °C

Duration: see chart

Fresh pasta / noodles	 [min.]
Gnocchi	2
Knöpfli	1
Ravioli	2
Spätzle	1
Tortellini	2
Dry pasta / noodles, covered with water	
Flat noodles / Fettuccine	14
Vermicelli	8

 Duration

European dumplings

Ready-made dumplings in wrappers need to be covered completely with water. Otherwise they will not absorb enough water and will fall apart, even if steeped in water prior to cooking.

Cook fresh dumplings in a greased, perforated container.

Settings

Automatic programmes  | Pasta | ... |

or

Steam cooking 

Temperature: 100 °C

Duration: see chart

	 [min.]
Steamed dumplings	30
Yeast dumplings	20
Boil-in-the-bag potato dumplings	20
Boil-in-the-bag bread dumplings	18–20

 Duration

Steam cooking

Dried pulses

Soak pulses for at least 10 hours in cold water before cooking. Soaking makes the pulses more digestible and shortens the cooking duration required. Soaked pulses must be covered with liquid during cooking.

Lentils do not need to be soaked before cooking.

With unsoaked pulses a certain ratio of pulses to liquid is required.

Settings

Automatic programmes  | Pulses | ... |

or

Steam cooking 

Temperature: 100 °C

Duration: see chart

Soaked	
	 [min.]
Beans	
Kidney beans	55–65
Adzuki beans	20–25
Black beans	55–60
Borlotti beans	55–65
Haricot beans	34–36
Peas	
Yellow split peas	40–50
Green peas, shelled	27

 Duration

Steam cooking

Unsoaked		
	Ratio Pulses : Liquid	⌚ [min.]
Beans		
Kidney beans	1 : 3	130–140
Adzuki beans	1 : 3	95–105
Black beans	1 : 3	100–120
Borlotti beans	1 : 3	115–135
Haricot beans	1 : 3	80–90
Lentils		
Brown lentils	1 : 2	13–14
Red lentils	1 : 2	7
Peas		
Yellow split peas	1 : 3	110–130
Green peas, shelled	1 : 3	60–70

⌚ Duration

Steam cooking

Hen's eggs

Use a perforated container to prepare boiled eggs in the steam combination oven.

The eggs do not need to be pierced before cooking as they are gradually warmed during the heating-up phase and so do not burst when they are cooked with steam.

When using a solid container for preparing egg dishes, remember to grease it first.

Settings

Automatic programmes  | Hen's eggs | ... |

or

Steam cooking 

Temperature: 100 °C

Duration: see chart

	 [min.]
Small (S) soft medium hard	 3 5 9
Medium (M) soft medium hard	 4 6 10
Large (L) soft medium hard	 5 6–7 12
Extra large (XL) soft medium hard	 6 8 13

 Duration

Fruit

Cook fruit in a solid container so that none of the juice is lost. If you wish to cook fruit in a perforated container, place a solid container directly underneath it to collect the juice.

Useful tip: You can use the collected juice to prepare a glaze for a fruit flan.

Settings

Automatic programmes  | Fruit | ... |

or

Steam cooking 

Temperature: 100 °C

Duration: see chart

	 [min.]
Apple chunks	1–3
Pear chunks	1–3
Cherries	2–4
Mirabelle plums	1–2
Nectarine/Peach chunks	1–2
Plums	1–3
Quinces, diced	6–8
Rhubarb chunks	1–2
Gooseberries	2–3

 Duration

Sausages

Settings

Automatic programmes  |

Sausages | ... |

or

Steam cooking 

Temperature: 90 °C

Duration: see chart

Sausages	 [min.]
Frankfurters	6–8
Sausages	6–8
White sausages	6–8

 Duration

Steam cooking

Shellfish

Preparation

Defrost frozen shellfish before cooking with steam.

Peel, remove and discard the intestines, and then wash the shellfish.

Cooking containers

If using a perforated container, grease it first or line it with baking paper.

Duration

The longer shellfish are cooked, the tougher they become. Use the cooking durations given in the chart.

When cooking shellfish in sauce or stock, we recommend that you increase the cooking duration quoted by a few minutes.

Settings



Automatic programmes  | Shellfish | ... |

or

Steam cooking 

Temperature: see chart

Duration: see chart

	 [°C]	 [min.]
Crevettes	90	3
Prawns	90	3
King prawns	90	4
Small shrimps	90	3
Crayfish	95	10–15
Large shrimps	90	3

 Temperature,  duration

Mussels

Fresh food

 Danger of food poisoning from spoiled mussels.
Spoiled mussels can cause food poisoning.
Only cook mussels which are closed.
Do not eat mussels which have not opened after being cooked.

Steep fresh mussels in water for a few hours before cooking to rinse out any sand. Then scrub the mussels thoroughly to clean them.

Frozen

Defrost frozen mussels before cooking.

Duration

The longer mussels are cooked, the harder they become. Use the cooking durations given in the chart.

Settings



Automatic programmes  | Mussels and clams | ... |

or

Steam cooking 

Temperature: see chart

Duration: see chart

	 [°C]	 [min.]
Goose barnacles	100	2
Cockles	100	2
Blue mussels	90	12
Scallops	90	3
Razor clams	100	2–4
Vongole	90	2–4

 Temperature,  duration

Steam cooking

Menu cooking - manual

Before cooking meals with the manual Menu cooking function, switch off steam reduction (see “Settings – Steam reduction”).

Menu cooking involves cooking various foods with different cooking times in order to serve them all together in one meal, e.g. rosefish fillet with rice and broccoli.

Foods are placed in the steam combination oven at different times so that they are all ready at the same time.

Shelf level

Place foods that produce a lot of liquid (e.g. fish) or have a distinctive colour (e.g. beetroot) directly above the universal tray. This avoids any transfer of flavour or colour to other food by preventing liquid dripping onto food below it.

Temperature

Whole meals should be cooked at a temperature of 100 °C as this is the temperature required to cook the majority of foods.

Do not cook a whole meal at the lowest temperature when different temperatures are required for different types of food, e.g. 85 °C for seabream and 100 °C for potatoes.

If the recommended cooking temperature for the food is 85 °C for example, try cooking it at 100 °C and testing the result. Some delicate types of fish with a soft structure, e.g. flounder will become very firm when cooked at 100 °C.

Duration

If you increase the recommended temperature, shorten the cooking duration by approx. $\frac{1}{3}$.

Example:

Food cooking durations

(see cooking charts in “Steam cooking”)

Parboiled rice	24 minutes
Rosefish fillet	6 minutes
Broccoli	4 minutes

Calculation of set cooking durations:

24 minutes minus

6 minutes = 18 minutes (1st cooking duration: rice)

6 minutes minus 4 minutes = 2 minutes (2nd cooking duration: rosefish fillet)

Remaining time = 4 minutes (3rd cooking duration: broccoli)

Duration	24 min. – rice		
		6 min. - rosefish fillet	
			4 min. - broccoli
Setting	18 min.	2 min.	4 min.

Cooking a whole menu

- Place the rice in the oven first.
- Set the first cooking duration:
18 minutes.
- After the 18 minutes, place the fish in
the oven.
- Set the second cooking duration:
2 minutes.
- After the 2 minutes, place the
broccoli in the oven.
- Set the third cooking duration:
4 minutes.

Sous-vide (vacuum) cooking

With this gentle cooking method, food is cooked slowly and at a low, constant temperature in vacuum packaging.

With vacuum cooking, no moisture evaporates during cooking and all nutrients and flavours are retained.

The cooking result has an intensive taste and food is cooked evenly.

Use only fresh food which is in a good condition.
Ensure hygienic conditions and that food has not been out of the refrigerator too long, e.g. during transportation.

Use only heat-stable, boiling-resistant vacuum bags.
Do not cook food in the sales packaging, such as vacuum-packed frozen food as it is possible that the packaging used is not suitable for vacuum cooking.
Do not use the vacuum bag more than once.

Vacuum-seal the food in a chamber system vacuum sealer only.

Sous-vide (vacuum) cooking

Important notes on use

For an optimum cooking result:

- Use herbs and spices more sparingly than with conventional cooking methods because the impact on the taste of the food will be stronger. You can also cook the food unseasoned and add seasoning after cooking.
- The cooking duration is reduced when salt, sugar, and liquids are added.
- The food becomes firmer if acidic foods, such as lemon or vinegar are added.
- Do not use alcohol or garlic as this can cause an unpleasant taste.
- Only use vacuum sealing bags that match the size of the food. If the vacuum bag is too big, too much air can remain inside.
- If you want to cook several pieces of food in one vacuum bag, put them side by side in the bag.
- If you want to cook food in several vacuum sealing bags at once, put the bags side by side on the rack.
- The cooking durations depend on the thickness of the food.
- Keep the door closed during the cooking process. Opening the door extends the cooking process and can change the cooking result.
- Temperatures and cooking durations from sous-vide recipes cannot always be emulated exactly. Alter the settings to achieve the degree of cooking you want.
- With higher temperatures and/or longer cooking durations, the appliance may run low on water. Check the display from time to time.

Sous-vide (vacuum) cooking

Useful tips

- In order to reduce cooking times, you can vacuum seal food items 1–2 days before the cooking programme. Store the vacuum-sealed food in the refrigerator at no more than 5 °C. In order to preserve quality and flavour, the food should be cooked no later than 2 days afterwards.
- Freeze liquids such as marinades before vacuum sealing to prevent them from escaping from the bag.
- Fold the edges of the vacuum sealing bag outwards for filling. This will give you clean, perfect weld seams.
- If you do not want to eat the food straight after cooking, put it in iced water immediately and allow it to cool down completely. After this, store the food at temperatures no greater than 5 °C.
This way, you can retain the food's quality and flavour while keeping it fresh for longer.
Exception: Poultry must be eaten straight after the cooking programme.
- After cooking, cut the vacuum bag on all sides for easier access to the food.
- Briefly fry meat and firm types of fish (such as salmon) before serving. This will help to develop a roasted aroma.
- Use the brine or marinade of vegetables, fish, or meat to make a sauce.
- Serve the food on pre-warmed plates.

Using the Sous-vide function

- Rinse the food with cold water and dry it.
- Place the food in a vacuum bag and add spices or liquid if desired.
- Vacuum seal the food in a chamber system vacuum sealer.
- For the best cooking results, place the rack on shelf level 2.
- Place the vacuum-sealed food on the rack (next to each other if there are several bags).
- Select Sous-vide .
- Change the recommended temperature if necessary.
- Confirm with *OK*.
- Set further settings as necessary (see “Operation”).

Possible causes for poor results

The vacuum bag has opened:

- The weld seam was not clean or stable enough and came undone.
- The bag was damaged by a sharp bone.

The food has an unpleasant or strange taste:

- Incorrect storage of the food; the food was kept out of the refrigerator for too long.
- The food was contaminated with bacteria before it was vacuum sealed.
- Too much of ingredients such as spices were added.
- The bag or weld seam were not in perfect order.
- The vacuum was insufficient.
- The food was not eaten or chilled immediately after cooking.

Sous-vide (vacuum) cooking

The cooking durations given in the tables are guidelines only. We recommend selecting the shorter duration initially. You can cook for longer if necessary. The cooking duration only begins when the set temperature is reached.

Food	Added in advance		🌡️ [°C]	⌚ [min.]
	Sugar	Salt		
Fish				
Blue eye trevalla/Ling fillet, 2.5 cm thick		x	54	35
Salmon fillet, 2–3 cm thick		x	52	30
Stargazer/Monkfish fillet		x	62	18
Vegetables				
Cauliflower florets, medium to large		x	85	40
Kohlrabi, sliced		x	85	30
White asparagus, whole	x	x	85	22–27
Sweet potato, sliced		x	85	18
Fruit				
Pineapple, sliced	x		85	75
Apples, sliced	x		80	20
Baby bananas, whole			62	10
Peaches, halved	x		62	25–30
Rhubarb chunks			75	13
Plums, halved	x		70	10–12
Other				
Beans, white, soaked at a 1:2 ratio (beans to liquid)		x	90	240
Prawns, peeled and deveined		x	56	19–21
Hen's egg, whole			65–66	60
Scallops, removed from shell			52	25
Shallots, whole	x	x	85	45–60

🌡️ Temperature, ⌚ duration

Sous-vide (vacuum) cooking

Food	Added in advance		🌡️ [°C]		🕒 [min.]
	Sugar	Salt	Medium*	Well-done*	
Meat					
Duck breast, whole		x	66	72	35
Saddle of lamb (on the bone)			58	62	50
Beef tenderloin, 4 cm thick			56	61	120
Beef rump steak, 2.5 cm thick			56	–	120
Pork fillet, whole		x	63	67	60

🌡️ Temperature, 🕒 duration

* Degree of doneness

The “Well-done” degree of doneness has a higher core temperature than “Medium,” but is not cooked through in the classical sense.

Sous-vide (vacuum) cooking

Reheating

Only reheat brassicas, such as kohlrabi and cauliflower, in combination with a sauce. Without sauce, an unpleasant cabbage-like taste and grey-brown colour may develop.

Foods with a short cooking time and those which have a different degree of doneness when reheated, e.g. fish, are not suited to being reheated.

Preparation

Immediately after cooking, place the food in ice cold water and leave for approximately one hour. The rapid cooling inhibits continued cooking of the food. This means the ideal degree of doneness of the food remains as it is. Store the food afterwards in the refrigerator at max. 3 °C.

Please note that the quality of food deteriorates the longer it is stored. We recommend storing food in the refrigerator for no longer than five days before reheating it.

Settings

Sous-vide 

Temperature: see chart

Duration: see chart

Sous-vide (vacuum) cooking

Reheating in the Sous-vide function

The durations specified in the chart are guidelines only. You can make the duration longer if necessary. The cooking duration only begins when the set temperature is reached.

Food	🌡️ [°C]		🕒 ² [min.]
	Medium ¹	Well-done ¹	
Meat			
Saddle of lamb (on the bone)	58	62	30
Beef tenderloin, 4 cm thick	56	61	30
Beef rump steak, 2.5 cm thick	56	–	30
Pork fillet, whole	63	67	30
Vegetables			
Cauliflower florets, medium to large ³	85		15
Kohlrabi, sliced ³	85		10
Fruit			
Pineapple, sliced	85		10
Other			
Beans, white, soaked at a 1:2 ratio (beans to liquid)	90		10
Shallots, whole	85		10

🌡️ Temperature, 🕒 duration

¹ Degree of doneness

The “Well-done” degree of doneness has a higher core temperature than “Medium,” but is not cooked through in the classical sense.

² The durations apply to vacuum-sealed food with an initial temperature of approx. 5 °C (refrigerator temperature).

³ Reheat only in sauce.

Other applications

Reheat

To reheat food which was cooked using the sous-vide method, use the Sous-vide  function (see “Sous-vide – Reheating”).

The steam oven is very effective at reheating food gently, without drying it out or cooking it further. The food reheats evenly and does not need to be stirred during the reheating process.

You can reheat individual dishes or plated meals which have been prepared previously (e.g. meat, vegetables and potatoes).

Suitable containers

Small quantities can be reheated on a plate, larger quantities should be placed in a cooking container.

Duration

10–12 minutes are usually sufficient for one plate of food. More than one plate will need a little longer.

If you are reheating several plated meals one after the other, the reheating time can be reduced by around 5 minutes for the second and subsequent plates as the oven compartment will still be hot.

Moisture content

The more moist the food, the less moisture that needs to be added.

Useful tips

- Do not reheat large items, such as a joint of roast meat, whole. Divide it into portions and reheat these as plated meals.
- Compact items, such as stuffed capsicum or roulades, should be cut in half.
- Reheat sauces separately. Exceptions are dishes such as goulash, which is cooked in sauce.
- Please note that breaded items, such as schnitzel, will not retain their crispness when they are reheated.

Food does not need to be covered before it is reheated.

Settings

Reheat 

or

Combi mode  | Combi Fan Plus

Temperature: see chart

Moisture: see chart

Duration: see chart

Other applications

The durations specified in the chart are guidelines only. We recommend selecting the shorter duration initially. You can make the duration longer if necessary.

Food	🌡️ [°C]	💧 [%]	🕒* [min.]
Vegetables			
Carrots Cauliflower Kohlrabi Beans	120	70	8–10
Side dishes			
Pasta Rice Potatoes, halved lengthways	120	70	8–10
Dumplings Mashed potato	140	70	18–20
Meat and poultry			
Sliced meat, 1.5 cm thick Roulades, sliced Goulash Lamb stew Meatballs Chicken schnitzel Turkey schnitzel, sliced	140	70	11–13
Fish			
Fish fillet Fish roulade, halved	140	70	10–12
Plated meals			
Spaghetti, Napoli sauce Roast pork, potatoes and vegetables Stuffed capsicum (halved), rice Chicken fricassee, rice Vegetable soup Creamy soup Clear soup Casserole	120	70	10–12

🌡️ Temperature, 💧 Moisture, 🕒 Duration

* These times apply to food heated on a plate.

Other applications

Defrost

It is much quicker to defrost items in the steam oven than at room temperature.

 Risk of infection from bacteria. Bacteria such as salmonella can cause life-threatening food poisoning.

It is particularly important to observe food hygiene rules when defrosting fish and meat, and in particular when defrosting poultry.

Do not use the liquid produced during defrosting.

Process the food as required as soon as it has been defrosted.

Temperature

60 °C is the best temperature for defrosting.

Exceptions: 50 °C for minced meat and game.

Before and after defrosting

Remove any packaging before defrosting.

Exceptions: Leave bread, biscuits and cakes in their packaging as otherwise they will absorb moisture and become soft.

Allow food to stand at room temperature for a few minutes after defrosting. The standing time is necessary to allow the even distribution of heat from the outside to the inside.

Cooking containers

Use a perforated container with the universal tray underneath when defrosting food which will drip, such as poultry. This way food will not be lying in defrosted liquid.

Foods which do not drip can be defrosted in a solid cooking container.

Useful tips

- Fish does not need to be fully defrosted before cooking. Defrost so that the surface is sufficiently thawed to take herbs and seasoning. Depending on the thickness of the fish, 2–5 minutes is generally enough.
- When defrosting food which has frozen together, e.g. berries and meat portions, separate them half-way through the defrosting time.
- Do not refreeze food once it has thawed.
- Defrost frozen ready meals according to the instructions on the packaging.

Settings

Defrost 

or

Steam cooking 

Temperature: see chart

Defrosting duration: see chart

Standing time: see chart

Other applications

The durations specified in the chart are guidelines only. We recommend selecting the shorter defrosting duration initially. You can make the defrosting duration longer if necessary.

Frozen food	Quantity	🌡️ [°C]	🕒 [min.]	⌚ [min.]
Dairy products				
Sliced cheese	125 g	60	15	10
Quark	250 g	60	20–25	10–15
Cream	250 g	60	20–25	10–15
Soft cheese	100 g	60	15	10–15
Fruit				
Apple sauce	250 g	60	20–25	10–15
Apple pieces	250 g	60	20–25	10–15
Apricots	500 g	60	25–28	15–20
Strawberries	300 g	60	8–10	10–12
Raspberries/Red/Blackcurrants	300 g	60	8	10–12
Cherries	150 g	60	15	10–15
Peaches	500 g	60	25–28	15–20
Plums	250 g	60	20–25	10–15
Gooseberries	250 g	60	20–22	10–15
Vegetables				
Frozen in a block	300 g	60	20–25	10–15
Fish				
Fish fillets	400 g	60	15	10–15
Trout	500 g	60	15–18	10–15
Lobster	300 g	60	25–30	10–15
Small shrimps	300 g	60	4–6	5
Ready meals				
Meat, vegetables, sides / Casserole / Soup	480 g	60	20–25	10–15

Other applications

Frozen food	Quantity	🌡️ [°C]	🕒 [min.]	⌚ [min.]
Meat				
Roast meat slices	125–150 g each	60	8–10	15–20
Minced meat	250 g	50	15–20	10–15
	500 g	50	20–30	10–15
Stew	500 g	60	30–40	10–15
	1000 g	60	50–60	10–15
Liver	250 g	60	20–25	10–15
Saddle of hare	500 g	50	30–40	10–15
Roebuck saddle	1000 g	50	40–50	10–15
Schnitzel/Chops/Sausages	800 g	60	25–35	15–20
Poultry				
Chicken	1000 g	60	40	15–20
Chicken thighs	150 g	60	20–25	10–15
Chicken fillet	500 g	60	25–30	10–15
Turkey drumsticks	500 g	60	40–45	10–15
Baked goods				
Puff pastries/Yeast buns	–	60	10–12	10–15
Creamed mixture cakes/biscuits	400 g	60	15	10–15
Bread/Rolls				
Bread rolls	–	60	30	2
Rye bread, sliced	250 g	60	40	15
Whole grain bread, sliced	250 g	60	65	15
White bread, sliced	150 g	60	30	20

🌡️ Temperature 🕒 Defrosting duration ⌚ Standing time

Mix & Match

The Mix & Match Special application is available to help with simple and uncomplicated preparation of plated meals. With this application, you can reheat food that has already been cooked (convenience food) or assemble a portioned-out meal using fresh food and cook it on a plate.

During cooking, you have the choice between a crispy, browned result or gently cooked food with a succulent surface without additional browning.

Only use food that is completely hygienic. If you have any concerns, dispose of the food.

Cooking containers

Use:

- a flat plate or a small ovenproof dish
- a deep bowl or a cup for food that requires liquid to be added

Baked goods, pizza, tarte flambée, etc. can be placed directly on the rack (with baking paper if necessary).

The plastic containers for ready meals are not sufficiently heat-resistant.

Transfer ready meals into suitable cooking containers.

Other applications

Tips for reheating plated meals

- For fried or gratin dishes, use **Crispy reheating** and for baked or boiled dishes, use **Gentle reheating**.
- Using **Crispy reheating** ensures that only food that was crispy before reheating stays crispy.
- The food should not exceed a height of 2–2.5 cm. Transfer taller food into flat containers (e.g. casserole) or slice it into smaller pieces (e.g. roulades, bakes).
- Only reheat pasta mixed into a sauce.
- Droplets of water may have accumulated underneath the crockery. Dry the droplets of water before serving.

Tips for cooking plated meals

- You can easily make a sauce from the meat and fish stock: add 1 tsp. of cornflour to the raw meat or fish before cooking. Stir the sauce with a fork until smooth before serving. You can also use 1 tsp. of mashed potato powder (instant) or a pinch of guar gum instead of cornflour.
- If cooking durations for different foods are not the same, you can compensate for this by changing the size of the food: if the cooking duration is shorter, make the pieces larger (e.g. large cauliflower florets). If the cooking duration is longer, make the pieces smaller (e.g. diced potatoes).
- You can also compensate for differing cooking durations with layering: place food with a short cooking duration under a food with a long cooking duration or put them together as a small bake.
- To prevent the food from drying out, prepare your dish with a sauce or marinade. You can also use cheese or bacon.

Assembling a plated meal using various components

For a good cooking result, you must put together the individual components of the dish – such as meat, side dishes and vegetables – so that a common setting can be selected for browning. This setting must be suitable for all elements of the meal, or at least conditionally suitable.

We recommend using the following procedure:

- Select a main ingredient based on the cooking charts, e.g. steak.
- Select other ingredients which have the corresponding settings for browning, e.g. green beans and rice.

Notes on the cooking charts

As well as information on portion sizes or the way the food needs to be processed prior to cooking, the cooking charts also provide tips on preparation.

The degree of browning is represented in the display by a bar with seven segments. Basically, the more segments that are filled, the longer the cooking duration.

You can use the icons to determine which setting is appropriate to brown the food:

Symbol	Meaning
—	Unsuitable
□	Conditionally suitable
■	Suitable

Other applications

Using the Mix & Match Special application

Food does not need to be covered while it is being cooked.

- Prepare the food as required.
- **Select:** Other  | Special applications | Mix & Match.
- If you are preparing food that is already **cooked**, select Gentle reheating or Crispy reheating.
- If you are preparing food that is **fresh** or just partially cooked, select Gentle cooking or Crispy cooking.
- Change the setting for browning if necessary.
- Confirm with *OK*.
- Place the food on the rack on shelf level 3.
- Confirm with *OK*.

You can start the cooking programme immediately or delay the start.

- If by the end of a cooking programme, the plated meal is not cooked enough for your taste, select Cont. browning.

Reheating food with the “Crispy reheating” Special application

Food	Browning segment bar setting
Apple strudel, 4 cm thick	___ _ _ _ <input type="checkbox"/> <input checked="" type="checkbox"/> <input type="checkbox"/> ___
Baked camembert, 25 g	___ _ _ _ <input checked="" type="checkbox"/> <input type="checkbox"/> ___
Baked camembert, 75 g	___ _ _ _ <input type="checkbox"/> <input checked="" type="checkbox"/> <input type="checkbox"/> ___
Baguettes, pre-baked	___ <input type="checkbox"/> <input checked="" type="checkbox"/> <input type="checkbox"/> ___
Puff pastry canapés	___ <input type="checkbox"/> <input checked="" type="checkbox"/> <input type="checkbox"/> <input type="checkbox"/> ___
Puff pastry pockets, filled with spinach	___ <input type="checkbox"/> <input checked="" type="checkbox"/> <input type="checkbox"/> ___
Börek pastry, 3 cm thick	___ _ _ _ <input type="checkbox"/> <input type="checkbox"/> <input checked="" type="checkbox"/> <input type="checkbox"/> ___
Fried potatoes (convenience)	___ _ _ _ <input type="checkbox"/> <input checked="" type="checkbox"/> <input type="checkbox"/> ___
Patty ¹ , tofu	___ <input type="checkbox"/> <input type="checkbox"/> <input checked="" type="checkbox"/> <input type="checkbox"/> ___
Bread roll (wheat), pre-baked	___ _ _ _ <input type="checkbox"/> <input checked="" type="checkbox"/> <input type="checkbox"/> ___
Bread roll (rye), pre-baked	___ _ _ _ <input type="checkbox"/> <input checked="" type="checkbox"/> ___
Bread roll, stale, soft	___ _ _ _ <input type="checkbox"/> <input checked="" type="checkbox"/> ___
Cheeseburger	___ _ _ _ <input type="checkbox"/> <input checked="" type="checkbox"/> ___
Chilli con carne ¹ , 2 cm thick	___ _ _ _ <input type="checkbox"/> <input checked="" type="checkbox"/> <input type="checkbox"/> ___
Ciabatta rolls, pre-baked	___ _ _ _ <input checked="" type="checkbox"/> <input type="checkbox"/> ___
Ciabatta rolls, stale, soft	___ _ _ _ <input checked="" type="checkbox"/> <input type="checkbox"/> ___
Crêpe ¹	___ _ _ _ <input type="checkbox"/> <input type="checkbox"/> ___
Tarte flambée (convenience)	___ <input type="checkbox"/> <input checked="" type="checkbox"/> <input type="checkbox"/> ___
Tarte flambée, ready-made dough with own toppings	___ <input type="checkbox"/> <input type="checkbox"/> <input checked="" type="checkbox"/> ___
Meat strips ¹ (convenience)	<input type="checkbox"/> <input type="checkbox"/> <input checked="" type="checkbox"/> <input type="checkbox"/> <input type="checkbox"/> ___
Focaccia, pre-baked, 3–4 cm thick	<input type="checkbox"/> <input type="checkbox"/> <input type="checkbox"/> <input checked="" type="checkbox"/> <input type="checkbox"/> ___
Rissole ¹ (pork), 25 g	<input type="checkbox"/> <input type="checkbox"/> <input checked="" type="checkbox"/> <input type="checkbox"/> <input type="checkbox"/> <input type="checkbox"/> ___
Rissole ¹ (pork), 60 g	___ _ _ _ <input type="checkbox"/> <input checked="" type="checkbox"/> <input type="checkbox"/> ___
Rissole ¹ (pork), 100 g	___ _ _ _ <input type="checkbox"/> <input type="checkbox"/> <input checked="" type="checkbox"/> <input type="checkbox"/> ___
Spring rolls, small	___ _ _ _ <input type="checkbox"/> <input checked="" type="checkbox"/> <input type="checkbox"/> ___
Spring rolls	___ _ _ _ <input type="checkbox"/> <input checked="" type="checkbox"/> <input type="checkbox"/> ___
Hot dog ¹	<input type="checkbox"/> <input type="checkbox"/> <input checked="" type="checkbox"/> <input type="checkbox"/> ___

Other applications

Food	Browning segment bar setting
Kaiserschmarrn pancake ¹ (convenience)	__ □ □ ■ □ □ __
Potatoes, fairly firm, sliced	__ __ □ ■ □ __ __
Potato pockets (convenience)	__ __ □ □ ■ □ __
Lasagne ¹ , 3 cm thick	__ _ _ ■ ■ ■ □ □
Naan ¹ , pre-baked	__ □ ■ □ __ _ _
Pasta, fresh with sauce, cheese	__ __ □ □ □ __
Pasta bake ¹ , 2 cm thick	__ _ _ ■ □ __
Pasta bake ¹ , 4.5 cm thick	__ _ _ □ ■ __
Pasta bake ¹ , 6 cm thick	__ _ _ _ □ ■
Pancakes ¹	■ □ _ _ _ _
Crêpes ¹ , rolled	__ __ □ ■ □ __
Pita ¹ , pre-baked	□ □ ■ □ _ _
Pizza (convenience)	□ □ ■ □ □ □ __
Poffertjes pancake	__ _ _ □ ■ □ __
Quiche, small	□ □ ■ □ _ _
Quiche, 2 cm thick	__ __ □ ■ □ __
Quiche, 3.5 cm thick	__ _ _ □ ■ □
Potato pancakes	__ _ _ ■ □ __
Hash browns (convenience)	__ _ _ □ ■ □ __
Schnitzel	__ __ □ ■ □ □ __
Taco shell	□ □ ■ □ □ □ __
Hawaii toast	__ □ ■ □ __ _
Cheese on toast	□ ■ _ _ _ _
Tortilla chips with cheese	__ □ ■ □ __
Tortilla ¹ (rolled in aluminium foil)	□ □ ■ □ □ __

¹ is not crispy, only needs to be sufficiently heated (> 65 °C).

Cooking food with the “Crispy cooking” Special application

Food	Cooking tips	Browning segment bar setting
Meat¹		
Bratwurst (pork), boiled, 25 g	Cut	___ _ _ _ □ □ ■ □
Bratwurst (pork), boiled, 100 g	Cut	___ _ _ _ _ □ □ □
Bratwurst (pork), coarse	Brush with oil, cut	___ _ _ _ _ _ □ ■
Fillet skewers (beef), large chunks	Marinated	□ ■ _ _ _ _ _ _
Meat skewers (pork), large chunks	Marinated	□ □ □ ■ □ _ _ _
Rissole (pork), 60 g	–	___ _ _ _ _ □ ■ □
Chicken breast, 3 cm thick	With bacon, marinated	□ □ □ ■ □ _ _ _
Chicken breast, 3 cm thick	On its own, marinated	_ □ □ ■ _ _ _ _
Stuffed chicken breast	Filling: spinach, crème fraîche	_ □ □ ■ _ _ _ _
Chicken skewer, large chunks	Marinated	□ □ ■ □ _ _ _ _
Chicken drumstick	Marinated	___ _ _ □ □ □ ■
Saddle of veal, 180 g	Marinated, with sauce	□ _ _ _ _ _ _ _
Gammon, 2.5–4 cm thick	–	___ _ □ ■ □ □ □
Gammon cutlet, 2 cm thick	–	_ □ □ ■ □ _ _ _
Lamb chop, 2 cm thick	Marinated	□ ■ □ □ _ _ _ _
Steak, 2.5–3.5 cm thick	Marinated	_ □ ■ □ _ _ _ _
Pork fillet, 4 cm thick	With bacon	□ □ ■ □ _ _ _ _
Pork chop	Crumbed, drizzled with oil	___ _ _ _ _ □
Fish¹		
Halibut cutlet	Marinated	□ ■ _ _ _ _ _ _
Blue eye trevalla/Ling	With butter and breadcrumb crust	___ _ _ □ ■ □ _
Blue eye trevalla/Ling fillet, 3–3.5 cm thick	Marinated	■ □ □ _ _ _ _ _
Blue eye trevalla/Ling fillet roulade	Stuffed	■ □ _ _ _ _ _ _
Salmon fillet, 2.5–3 cm thick	Marinated	□ □ ■ □ □ _ _ _
Salmon cutlet	Marinated	□ □ ■ □ □ _ _ _
Salmon skewer, large chunks	Marinated	□ □ ■ □ □ _ _ _
Blue grenadier fillet	Topping: spinach, feta	■ □ _ _ _ _ _ _

Other applications

Food	Cooking tips	Browning segment bar setting
Tuna	With tomatoes, topped with cheese	--- □ ---
Side dishes		
Fried potatoes (convenience), gently fried	–	--- □ □ □ ■
Dates in bacon (convenience)	–	_ □ □ ■ □ _
Fresh pasta, tortellini	–	□ _ _ _ _ _
Gnocchi (convenience)	With small chunks of butter or cheese	■ □ _ _ _ _
Potatoes ² , slices/small cubes	Brush with oil	--- □ □ □ ■
Potato pockets (convenience), pre-cooked	–	■ □ _ _ _ _
Lasagne, pre-cooked, 3 cm thick	–	□ □ _ _ _ _
Brown rice, cooking duration 8 minutes	Salt, 1 : 2 (rice : liquid)	_ □ ■ _ _ _
Pasta bake, fresh pasta	Raw meat, vegetables, sauce	_ □ □ ■ □ □ □
Pasta bake, pre-cooked, 2 cm thick	–	□ _ _ _ _ _
Potato pancakes (convenience mixture)	Brush with oil	--- □ □ _ _
Rice (convenience), pre-cooked	–	□ □ ■ □ _ _
Hash browns (convenience), pre-cooked	–	■ □ _ _ _ _
Potato dumplings (convenience)	With small chunks of butter	□ □ □ □ □ □ _
Vegetables		
Eggplant, 2 cm thick	Oil, salt, pepper	--- □ □ _ _
Cauliflower, large florets	Salt and pepper	□ _ _ _ _ _
Broccoli, large florets	Sauce	□ ■ □ _ _ _
Beans, green (string beans)	With bacon, salt, pepper	--- ■ □ _ _
Cherry tomatoes, whole	Marinated	■ □ □ □ _ _
Kohlrabi, thick slices	Marinated	□ □ □ □ _ _
Pumpkin, in small cubes	Salt and pepper	■ □ _ _ _ _
Corn on the cob	Marinated	_ □ □ ■ □ _
Carrots, quartered/in thick slices	Salt and pepper	□ □ □ □ _ _

Other applications

Food	Cooking tips	Browning segment bar setting
Capsicum, large chunks	Marinated	□ □ □ ■ □ _ _
Ratatouille, roughly chopped	Tomato paste, ketchup, seasoning, cornflour	□ □ _ _ _ _ _
Zucchini, 2 cm thick	Oil, salt, pepper	_ _ _ □ □ _ _
Other		
Baked camembert, 25 g	-	■ _ _ _ _ _ _
Baguette, part-baked bread rolls	-	□ ■ _ _ _ _ _
Bread roll, stale, soft	-	□ □ _ _ _ _ _
Cheeseburger, pre-cooked	-	□ _ _ _ _ _ _
Tarte flambée (convenience)	-	_ _ _ □ ■ _ _
Tarte flambée, ready-made dough with own toppings	-	_ _ □ ■ □ _ _
Spring roll, frozen, 25 g	-	_ □ ■ □ _ _ _
Spring roll, frozen, 100 g	-	_ □ □ □ _ _ _
Grilled cheese (convenience)	-	_ _ _ □ ■ _
Kaiserschmarrn pancake (convenience)	-	_ _ □ ■ □ _
Kaiserschmarrn pancake, uncooked	-	_ _ _ □ _ _
Tofu patty, pre-cooked	-	■ _ _ _ _ _
Onion tart (convenience)	-	_ _ _ _ □ □

¹ Add 1 tsp. cornflour to raw meat/fish.

² Fairly firm

Other applications

Food suitable for the “Gentle cooking” Special application

Food	Cooking tip
Meat¹	
Bockwurst (pork)	–
Fillet skewers (beef), large chunks	Marinated with peanut sauce
Meat skewers (pork)	Marinated
Chicken breast, 150 g, 3 cm thick	On its own
Stuffed chicken breast	Filling: spinach, crème fraîche
Chicken skewer, large chunks	Marinated
Chicken fricassee	–
Saddle of veal, 180 g	In sauce
Gammon, 230 g, 2.5–4 cm thick	Salt and pepper
Gammon cutlet (pork), 200 g, 2 cm thick	Salt and pepper
Meatballs (pork), 50–100 g each	In sauce
Fish¹	
Trout, whole, without head	Seasoned, butter
Blue eye trevalla/Ling fillet, 3–3.5 cm thick	Marinated
Blue eye trevalla/Ling fillet roulade	Stuffed, marinated
Salmon fillet, 2.5–3 cm thick	Marinated
Salmon cutlet	Marinated
Salmon skewer, large chunks	Marinated
Blue grenadier fillet, 180 g	Topping: spinach and crème fraîche
Blue grenadier fricassee, large chunks	With white sauce
Catfish skewer, large chunks	Marinated
Side dishes	
Basmati rice	Salt, ratio 1 : 2.5 (rice : liquid)
Fresh pasta, tortellini	Sauce, salt
Gnocchi (convenience)	Salt, covered with water
Potatoes, floury, halved	Salt
Potatoes ² , sliced or small cubes	Salt
Potatoes ² , quartered or in wedges	Salt

Other applications

Food	Cooking tip
Boil-in-the-bag potato dumplings (convenience)	Covered with water
Mashed potato, cooked	–
Mashed potato (convenience), dry product	According to the packet instructions
Macaroni, short, uncooked	Sauce, ratio 1 : 3 (pasta : water)
Brown rice, cooking duration 8 minutes	Salt, ratio 1 : 2 (rice : liquid)
Parboiled rice (convenience), cooking duration 8 minutes	Salt, ratio 1 : 2 (rice : liquid)
Parboiled rice, cooking duration 10–12 minutes	Salt, ratio 1 : 2 (rice : liquid)
Rice (convenience), pre-cooked	Salt
Potato dumplings (convenience)	Salt, small chunks of butter
Vermicelli, uncooked	Covered with stock
Vegetables	
Cauliflower, large florets	Salt
Beans, green (string beans)	With bacon or salt, pepper
Broccoli, large florets	With/Without cheese sauce
Cherry tomatoes, whole	Marinated
Kohlrabi, sliced	Salt and pepper
Pumpkin, in small cubes	Salt and pepper
Corn on the cob	Herb butter
Carrots, quartered or in thick slices	Seasoned
Capsicum, large chunks	Marinated
Ratatouille, roughly chopped	Tomato paste, ketchup, seasoning, cornflour
Brussels sprouts, whole	Salt and pepper
Asparagus, spears, whole, 1–2 cm thick	Salt, pepper, small chunks of butter
Zucchini, sliced, 2 cm thick	Oil, salt, pepper

¹ Add 1 tsp. cornflour to raw meat/fish.

² Fairly firm

Other applications

Menu cooking – automatic

When cooking a menu automatically, you can combine up to 3 different foods in a single menu, e.g. fish fillet with rice and vegetables.

With menu cooking, the food is placed in the steam oven at different times so that each item is ready at the same time.

You can select items of food in any order, because the steam oven sorts them according to cooking duration and indicates when each item has to be placed in the oven.

The Finish at and Start at functions are not available with menu cooking.

Using the Menu cooking Special application

- Select Other  | Special applications | Menu cooking.
- Select the food you want.

Depending on the type of food selected, you will be asked about the size, weight and how well you want it cooked.

- Select the values required and then confirm each one with *OK*.
- Select Add food.
- Select the next food you want and proceed as described for the first type of food.
- Repeat for the third type of food if necessary.

After confirming Start menu cooking, you will be prompted to place the food with the longest cooking duration in the oven.

- When using perforated containers to cook foods that produce a lot of liquid or have a distinctive colour, be sure to place them over the universal tray. This avoids any transfer of flavour or colour to other food by preventing liquid dripping onto food below it.

At the end of the heating-up phase, the steam combination oven will indicate when the next item of food has to be placed inside. Once this time has been reached, a buzzer will sound. This process is repeated once again if there is a third food item.

You can still cook food types not listed in the display together to prepare a menu. Please refer to "Steam cooking – Menu cooking – manual" for more information.

Blanch

Blanch fruit and vegetables before freezing them. Blanching helps maintain the quality of the produce when it is frozen.

Blanching vegetables also helps them retain their original colour.

- Put the prepared vegetables (cleaned, washed, chopped etc.) into a perforated cooking container and place in the steam combination oven.
- Once blanched, plunge the vegetables into ice cold water to cool them down quickly. Drain them well.

Settings

Other  | Special applications | Blanch

or

Steam cooking 

Temperature: 100 °C

Blanching time: 1 minute

Bottling

Only use unblemished, fresh produce which is in good condition.

Glass jars

Use clean glass jars and accessories and check them for any defects. Glass jars with twist off lids or glass lids with a rubber seal are suitable.

Make sure that all the glass jars are the same size so that bottling is carried out evenly.

After you have filled the jars with the bottled produce, clean the glass rims with a clean cloth and hot water and then seal the jars.

Fruit

Sort fruit carefully, rinse it briefly but thoroughly and allow it to drain. Take great care when cleaning soft fruit as it is very delicate and squashes easily.

Remove any peel, stalks, cores or stones. Cut up large fruit. For example, cut apples into slices.

If you are bottling fruit with stones (e.g. plums, apricots) without removing the stones, pierce the fruit several times with a fork or wooden skewer as otherwise it will burst.

Other applications

Vegetables

Rinse, clean and cut up vegetables.

Vegetables should be blanched before bottling to help them retain their colour (see “Special applications – Blanching”).

Fill volume

Fill the glass jars with produce up to no more than 3 cm below the rim. Do not pack it down as this will damage the cell walls of the produce. Tap the jar gently onto a cloth to help distribute the contents evenly. Fill the jars with liquid. The produce must be completely covered.

Use a sugar solution for fruit and a salt or vinegar solution for vegetables.

Meat and sausages

Briefly fry or cook the meat before bottling. Use the juices with some added water, or the broth in which the meat was cooked, as the liquid content of the jars. Make sure there is no grease on the rim of the jars.

When bottling sausages, only fill the jars to halfway as the meat will rise during the bottling process.



Useful tips

- Make use of residual heat by leaving the jars in the oven for 30 minutes after it has switched off.
- Then cover the jars with a cloth and allow to cool for approx. 24 hours.

Bottling food

- Place a perforated container or the rack on level 1.
- Place the closed jars in the perforated container or on the rack. The jars must not touch each other.

Settings

Other  | Special applications | Bottling
or
Steam cooking 

Temperature: see chart

Bottling duration: see chart

Other applications

The durations specified in the chart are guidelines only.

Food	🌡️ [°C]	🕒* [min.]
Berries		
Red / Blackcurrants	80	50
Gooseberries	80	55
Cranberries	80	55
Fruit with stones		
Cherries	85	55
Mirabelle plums	85	55
Plums	85	55
Peaches	85	55
Greengage plums	85	55
Fruit with pips		
Apples	90	50
Apple sauce	90	65
Quinces	90	65
Vegetables		
Beans	100	120
Broad beans	100	120
Gherkins	90	55
Beetroot	100	60
Meat		
Pre-cooked	90	90
Roasted	90	90

🌡️ Temperature, 🕒 Duration

* Bottling durations apply to 1.0 l jars. If using 0.5 l jars, reduce the duration by 15 minutes. If using 0.25 l jars, reduce the duration by 20 minutes.

Other applications

Bottling cakes

Creamed, sponge and yeast dough mixtures are all suitable for bottling. Cakes will keep for approx. 6 months.

Cakes **made with fresh fruit** are **not suitable for long term storage**, and must be consumed within 2 days of being made.





Only use sterilised jars and accessories. The jars must be narrower at the bottom than at the top (mason jars). 0.25 l jars are the best for this purpose.

The jars need to have a bottling ring, glass lid and a spring lock clip to be sealed.



Make sure that all the jars are the same size so that the bottling process is carried out evenly.

- Grease the inside of the jars with butter up to 1 cm below the rim.
- Sprinkle inside the jars with fine breadcrumbs.
- Fill the jars $\frac{1}{2}$ to $\frac{2}{3}$ full with mixture (depending on recipe). Make sure the rim stays clean.
- Place the rack on shelf level 2.
- Place the **open** jars (all the same size) on the rack. The jars must not touch each other.
- Close the jars **immediately** after bottling by clamping the glass lid down securely. Do not let the cakes cool down. If the mixture has risen above the rim, it can be pushed back down into the jar with the glass lid.

The durations specified in the chart are guidelines only. We recommend selecting the shorter duration initially. You can extend the duration if necessary.

Type of mixture	Oven function	Stage	🌡️ [°C]	💧 [%]	🕒 [min.]
Creamed mixture		–	160	–	35–45
Sponge		–	160	–	50–55
Yeast dough		1	30	100	10
		2	160	30	30–35

🌡️ Temperature, 💧 Moisture, 🕒 Duration

 Conventional Heat,  Combi mode Conventional

Drying

Only use the Drying Special application or the Combi Fan Plus function to dry food so that moisture can be dissipated.

Bananas, pineapple and some types of mushrooms are not suitable for drying.

- Cut the food for drying into equally sized pieces.
- Line the rack with baking paper and distribute the food for drying evenly in a single layer if possible.
- Allow the fruit or vegetables to cool down after drying.
- Store dried food in sealed glass jars or tins.
To prevent mould from forming and the food from decomposing, make sure that no moisture gets into the storage container.

Settings

Other  | Special applications | Drying

Temperature: see chart

Drying time: see chart

or

Combi mode  | Combi Fan Plus

Temperature: see chart

Moisture: 0%

Drying time: see chart

The drying times specified in the chart are guidelines only. We recommend selecting the shorter drying time initially. You can make the duration longer if necessary.

Food	🌡️ [°C]	🕒 [h]
Apple, rings	70	6–8
Apricots, halved, stones removed	60–70	10–12
Pears, sliced	70	7–9
Herbs	40	1.5–2.5
Mushrooms*	50	5–7
Tomatoes, sliced	70	7–9
Citrus fruit, sliced	70	8–9
Damsons, stones removed	60–70	10–12

🌡️ Temperature, 🕒 Drying time (hours)

* Porcini, shiitake, morels, wood ear and bay bolete are suitable for drying. The mushrooms are sufficiently dried when they are “cracker dry”.

Other applications

Prove yeast dough

- Prepare the dough according to the recipe.
- Place the dough in an uncovered bowl in a perforated container or on the inserted rack.
Depending on the size of the bowl, you can also place the rack on the floor of the oven compartment with the rack surface facing up and place the bowl on top. If necessary, you can also remove the shelf runners.

Settings

Other  | Special applications | Prove yeast dough

or

Steam cooking 

Temperature: 30 °C

Moisture: 100%

Duration: as per recipe instructions

Disinfect items

The steam oven will disinfect baby bottles and other containers so that at the end of the programme they are as germ free as they would have been if boiled. Check beforehand that all parts, teats etc. are declared by the manufacturer to be heat resistant to 100 °C and also that they can withstand hot steam.

Dismantle, clean and thoroughly rinse baby bottles. Reassemble the bottles only after they have completely dried. This prevents recontamination.

- Place the individual items on the rack or in a perforated container (on their sides or with the opening facing downwards) ensuring that they do not touch one another. This will allow hot steam to reach them from all sides.

Settings

Other  | Special applications | Disinfect items

Duration: 1 minute to 10 hours

or

Steam cooking 

Temperature: 100 °C

Duration: 15 minutes

Sabbath programme

The Sabbath programme and Yom Tov Special applications help to support religious observance.

The steam oven will heat up to the temperature you have set and will maintain this temperature for a maximum of 24 hours (Sabbath programme) or 76 hours (Yom Tov).

- Select Other  | Special applications.
- Select Sabbath programme.
- Select the required Special application.

You will not be able to start this Special application if you have set a minute minder.

- Set the temperature.
- Confirm with *OK*.

The name of the Special application and the set temperature appear in the display.

The oven heating switches on around 30 seconds after you have closed the door.

The oven interior lighting remains switched on during the entire cooking period.

Sabbath programme or Yom Tov and the set temperature appear permanently in the display.

The time of day does not appear. None of the sensors reacts (except for the On/Off  sensor).

The message Do not open the door will appear.

After around 1 hour, this information switches off from time to time. You can open the door when this message is **not** shown.

- Place the food in the oven.

The Sabbath programme Special application ends after 24 hours. The display does not change.

In both Special applications, the steam oven switches off automatically after 76 hours.

- If you want to end the Special application prematurely, switch off the steam oven using the On/Off  sensor.

Once a Special application has started, it cannot be changed or saved under User programmes.

Other applications

Heat crockery

By pre-heating the crockery, the food does not cool down as quickly.

Use heat-resistant crockery.

- Place the rack on shelf level 2 and place the crockery to be pre-heated on it. Depending on the size of the crockery, you can also place the rack on the floor of the oven compartment with the rack surface facing up and the crockery on top. If necessary, you can also remove the shelf runners.
- Select Other  | Special applications.
- Select Heat crockery.
- Alter the recommended temperature if necessary and then set the duration.

 Risk of injury caused by hot surfaces.

The steam oven gets hot during operation. You could burn yourself on the heating elements, oven compartment, shelf runners or accessories. Droplets of water may have accumulated underneath the crockery.

Wear oven gloves when removing dishes from the oven.

Keeping warm

You can keep food warm in the oven compartment for up to 2 hours.

In order to maintain the quality of food, select the shortest possible time.

- Select Other  | Special applications.
- Select Keeping warm.
- Place the food to be kept warm in the oven and confirm with *OK*.
- Alter the recommended temperature if necessary and then set the duration.

Heat damp towels

- Moisten towels and then roll them up.
- Place them beside one another in a perforated cooking container.

Settings

Automatic programmes  | Special | Heat damp towels

or

Steam cooking 

Temperature: 70 °C

Duration: 2 minutes

Dissolve gelatine

- Soften **gelatine leaves** by leaving them in a bowl of cold water for 5 minutes. The gelatine leaves have to be fully covered with water. Remove the gelatine leaves from the bowl and squeeze them out. Empty the bowl. Place the squeezed gelatine leaves back in the bowl.
- **Gelatine powder:** Place the gelatine powder in a bowl and add water according to the instructions on the packaging.
- Cover the bowl and place it in a perforated cooking container.

Settings

Automatic programmes  | Special | Dissolve gelatine

or

Steam cooking 

Temperature: 90 °C

Cooking duration: 1 minute

Other applications

Decrystallise honey

- Loosen the lid and place the jar of honey in a perforated cooking container.
- Stir the honey once during the process.

When liquefying (decrystallising) honey at a temperature of 60 °C, the main focus is on obtaining a spreadable food product again.

Settings

Automatic programmes  | Special |
Decrystallise honey

or

Steam cooking 
Temperature: 60 °C

Duration: 90 minutes (irrespective of the size of jar or the amount of honey in the jar)

Melt chocolate

You can use the steam oven for melting any type of chocolate.

When using a cake glaze, place it in a perforated cooking container, leaving it in its packaging.

- Break the chocolate into small pieces.
- Place large quantities in a solid container and small quantities in a cup or a bowl.
- Cover the container or the dish with a lid or with foil that is resistant to temperatures up to 100 °C and to hot steam.
- Stir large quantities once during cooking.

Settings

Automatic programmes  | Special | Melt chocolate

or

Steam cooking 
Temperature: 65 °C
Duration: 20 minutes

Make yoghurt

To prepare yoghurt, you will need milk and live culture or yoghurt starter powder, e.g. from a health food store.

Use natural yogurt with live culture and without additives. Do not use heat-treated yogurt.

The yoghurt must be fresh (short storage time).

You can use either unchilled long-life milk or fresh milk.

Long-life milk can be used as it is – no further preparation is required. Fresh milk must first be heated to 90 °C (do not boil it) and then cooled down to 35 °C. Fresh milk will give a better set than long-life milk.

The yoghurt and milk should have the same percentage fat.

Do not move or shake the jars while the yoghurt is fermenting.

Immediately after preparation, leave the yoghurt to cool in the fridge.

The firmness, fat content and cultures used in the yoghurt starter all affect the consistency of homemade yoghurt. Not all yoghurts are equally suitable as yoghurt starters.

Useful tip: If you are using yoghurt starter powder, you can prepare the yoghurt from a mixture of milk and cream. For that, mix $\frac{3}{4}$ litre milk with $\frac{1}{4}$ litre cream.

- Mix 100 g yoghurt with 1 litre of milk or make up the mixture with yoghurt enzyme, following the instructions on the packaging.
- Pour the mixture into glass jars and seal the jars.
- Place the sealed jars in a perforated cooking container or on the rack. The jars must not touch each other.
- Straight after the cooking duration has finished, place the jars in the refrigerator. Take care not to shake the jars unnecessarily.

Settings

Automatic programmes  | Special |
Make yoghurt

or

Steam cooking 

Temperature: 40 °C

Duration: 5:00 hours

Possible causes for poor results

Yoghurt is not set:

Incorrect storage of the yoghurt starter, too much time out of the refrigerator, packaging was damaged, milk was insufficiently heated.

Liquid has not been removed:

Jars were moved, the yoghurt cooled down too slowly.

Yoghurt is grainy:

The milk was heated too high, it was not free of imperfections, the milk and yoghurt starter were not stirred evenly.

Other applications

Render fat

The bacon will not become brown.

- Place the bacon (diced or rashers) in a solid cooking container.
- Cover the container with foil that is temperature-resistant up to 100 °C and resistant to steam.

Settings

Automatic programmes  | Special |
Render fat

or

Steam cooking 
Temperature: 100 °C
Duration: 4 minutes

Sweat onions

Sweating means cooking the onions in their own juices, with the addition of a little fat if necessary.

- Cut the onions up into small pieces and place them in a solid cooking container with a little butter.
- Cover the container with foil that is temperature-resistant up to 100 °C and resistant to steam.

Settings

Automatic programmes  | Special |
Sweat onions

or

Steam cooking 
Temperature: 100 °C
Duration: 4 minutes

Extracting juice

This appliance is ideal for extracting juice from soft, firm and hard fruit.

It is best to use overripe fruit, as the riper the fruit, the greater the quantity of juice produced. Very ripe fruit will also produce a more intense flavour.

Preparation

Sort and rinse the fruit, and cut out any blemishes.

Remove the stalks from grapes and morello cherries as these are bitter. Berries do not need to have their stalks removed.

Dice larger fruit such as apples into approximately 2 cm cubes. The harder the fruit, the smaller the pieces should be.

Useful tips

- Try experimenting with mild and tart flavours. For example, mix apples with elderberries.
- Adding sugar will increase the quantity of juice produced and improve the flavour. Sprinkle the fruit with sugar and leave to absorb for a few hours before juicing. For 1 kg of sweet fruit add 50–100 g of sugar, and for 1 kg of tart fruit add 100–150 g of sugar.
- If you wish to bottle the juice rather than consume it straight away, pour it whilst hot into hot, sterilised bottles up to the rim, and then seal immediately with sterilised rubber tops.

Extracting juice from fruit

- Put the prepared fruit (cleaned, washed, chopped etc.) into a perforated cooking container.
- Place a solid cooking container or the universal tray underneath in order to collect the juice.

Settings

Steam cooking 

Temperature: 100 °C

Duration: 40-70 minutes

Other applications

Fruit jam

Only use unblemished, fresh produce which is in good condition.

Glass jars

Only use sterilised jars with twist-off lids up to a maximum capacity of 250 ml.

After pouring in the jam, clean the outside of the rim of the jar with a cloth and hot water.

Preparation

Sort fruit carefully, rinse it briefly but thoroughly and allow it to drain. Take great care when cleaning soft fruit as it is very delicate and squashes easily. Remove any stalks, cores or stones.

Purée the fruit as otherwise the preserve will not set. Add jam sugar to the fruit (according to packet instructions) and stir well.

For sweet fruit and berries you should also add some citric acid.

Making jam

- Fill jars to maximum 2/3 full.
- Place the open jars in a perforated cooking container or on the rack.
- Leave the jars to stand for 1–2 minutes after the end of the process.
- Afterwards, seal the jars with a lid and allow the jars to cool down.

Settings

Combi mode  | Combi Fan Plus
Temperature: 150 °C
Moisture: 0%
Duration: 35–45 minutes

Skinning fruit and vegetables

- Cut a cross in the top of tomatoes, nectarines etc. This will allow the skin to be removed more easily.
- Place the food in a perforated container if cooking with steam, or a universal tray if using the grill.
- To blanch almonds, it is important to plunge them into cold water as soon as they are taken out of the oven as otherwise the skin cannot be removed.

Settings

Other  | Full Grill

Setting: 3

Duration: see chart

Food	⌚ [min.]
Capsicum	10
Tomatoes	7

⌚ Duration

Settings

Steam cooking 

Temperature: 100 °C

Duration: see chart

Produce	⌚ [min.]
Apricots	1
Almonds	1
Nectarines	1
Capsicum	4
Peaches	1
Tomatoes	1

⌚ Duration

Other applications

Preserving apples

You can treat homegrown apples in the steam combination oven to increase the length of time for which you can store them. Once treated, the apples will keep for 5 to 6 months when stored in a dry, cool and well-ventilated place. This method is only suitable for apples and not for other types of fruit.

Settings

Automatic programmes  | Fruit | Apples | Whole

or

Steam cooking 

Temperature: 50 °C

Preserving time: 5 minutes

Preparing custard royale

- Stir 6 eggs into 375 ml milk (do not beat into a foam).
- Season the egg/milk mixture and pour into a solid cooking container greased with butter.

Settings

Steam cooking 

Temperature: 100 °C

Duration: 4 minutes

The wide range of Automatic programmes enable you to achieve excellent results with ease.

Categories

The  Automatic programmes are sorted into categories to provide a better overview. Simply select the appropriate Automatic programme for the type of food you are cooking and follow the instructions in the display.

Using Automatic programmes

- Select Automatic programmes .

A list will appear.

- Select the desired food category.

The Automatic programmes available for the food type selected will then appear.

- Select the Automatic programme that you want to use.
- Follow the instructions in the display.

Useful tip: Use  Info to display information such as how to place or turn the food depending on the cooking programme.

Usage notes

- After cooking, allow the oven compartment to cool down to room temperature again before starting an Automatic programme.
- The weights specified in the Automatic programmes refer to the weight per piece. For example, you can cook just one piece of salmon weighing 250 g or 10 pieces of salmon, each weighing 250 g, at the same time.
- The degree of cooking and browning are represented by a bar with seven segments. You can set the desired degree of cooking or browning using the navigation area.
- Please refer to recipes for information on suitable baking containers.
- In the Rice category, you can select General in addition to the long-grain and short-grain rice programmes. Use this Automatic programme if you want to prepare long-grain or short-grain rice varieties that are not available as a specific Automatic programme.
- For some Automatic programmes, the start or end time can be delayed using Start at or Finish at.

Automatic programmes

- The individual cooking stages of the Automatic programme are listed under the **Show cooking stages** menu option. The **Display actions** menu option is also available for some Automatic programmes. You can call up required actions, e.g. placing food in the oven or adding ingredients, via this menu option. During the cooking process, you can view the actions via **i** Info.
- When you place food in the hot oven compartment, be careful when opening the door. Hot steam may escape. Step back and wait until the steam has dissipated. Avoid contact with hot steam, and do not touch the hot oven compartment walls. Danger of burning and scalding.
- If by the end of an Automatic programme the food is not cooked enough, select **Continue cooking** or **Continue baking**.
- Automatic programmes can also be saved as **User programmes**. To do this, select the **↶** sensor after an Automatic programme has finished.

You can create and save up to 20 of your own programmes.

- You can combine up to 9 cooking stages to accurately programme your favourite or most frequently used recipes. In each cooking stage, you can select settings such as the function, temperature and cooking duration.
- You can enter the name of the programme for your recipe.

When you call up and start your programme the next time, it will run automatically.

There are different ways of creating a User programme:

- At the end of an Automatic programme or Special application, save it as a User programme.
- After running a programme with a set duration, save it.

Then name the programme.

Creating a User programme

- Select User programmes .
- Select Create programme.

You can now specify the settings for the first cooking stage.

Follow the instructions in the display:

- Select and confirm the desired settings.

If you select the Pre-heat function, first complete the first cooking stage. Use Add cooking stage to then add another cooking stage where you set a cooking duration. Only then can you save or start the programme.

- If required, select Further parameters to switch the Booster function and Crisp function on or off.
- Select Complete cooking stage.

All settings for the first cooking stage have now been set.

You can add more cooking stages, for example, if you want to add another cooking function to follow on from the first.

- If additional cooking stages are required, select Add cooking stage and proceed as you did for the first cooking stage.

If you want to check the settings or to change them at a later date, select the cooking stage in question.

User programmes

■ When you have finished setting all the cooking stages, select *Save*.

■ Enter the programme name.

■ Select *✓*.

A message will appear in the display confirming that the new name has been saved.

■ Confirm with *OK*.

You can start the saved programme immediately, delay the start or change the cooking stages.

Starting a User programme

■ Place the food in the oven.

■ Select *User programmes* .

■ Select the required programme.

■ Select *Allow*.

Depending on the programme settings, the following menu options will appear in the display:

- *Start now*
The programme will start immediately. The oven heating will switch on immediately.
- *Finish at*
Specify the time at which the programme should finish. The oven heating will switch off automatically at the time you have set.
- *Start at*
Specify the time at which you want the programme to start. The oven heating will switch on automatically at the time you have set.

- *Show cooking stages*

A summary of your settings will appear in the display.

- *Display actions*

The required actions, e.g. placing the food in the oven, will appear in the display.

■ Select the required menu option.

The programme selected will begin straight away or at the time set.

Use  *Info* to display information such as how to place or turn the food depending on the cooking programme.

■ At the end of the programme, select the  sensor.

Changing cooking stages

Cooking stages in an Automatic programme that you have renamed as a User programme cannot be changed.



- Select User programmes .
- Select the programme you want to change.
- Select Change programme.
- Select the cooking stage that you want to change or Add cooking stage to add another cooking stage.
- Select and confirm the desired settings.
- If you want to start the modified programme without changing it, select Start programme.
- Select Save when you have changed all the settings.

A message will appear in the display confirming that the new name has been saved.

- Confirm with *OK*.

The saved programme has been changed and you can start it immediately or delay the start.

Changing a name

- Select User programmes .
- Select the programme you want to change.
- Select Change name.
- Change the programme name.
- Select .

A message will appear in the display confirming that the new name has been saved.

- Confirm with *OK*.

The programme has been renamed.

Deleting User programmes

- Select User programmes .
- Select the programme you want to delete.
- Select Delete programme.
- Confirm the request with *Yes*.

The programme is deleted.

Go to Other  | Settings  | Factory default | User programmes to delete all User programmes at the same time.

Baking

Handling food carefully will help protect your health.

Cakes, pizzas and chips should be cooked until golden, not dark brown.

Baking guidelines

- Set a cooking duration. When baking, the oven should not be set to start a long time off. Otherwise the cake mixture or dough will dry out, and the raising agents will lose their effectiveness.
- Generally, you can use the rack, universal tray and any type of baking tray made of heat-resistant material.
- Always place bakeware on the rack.
- Always cook frozen goods such as cakes, pizza or baguettes on the rack.

Very high temperatures can cause the universal tray to distort to such an extent that the tray cannot be taken out of the oven compartment.

- Small items of frozen food such as oven chips or potato croquettes can be cooked on the universal tray. Turn these frozen food items several times during cooking.
- Bake on a maximum of 2 levels at once.

Using baking paper

Miele accessories, e.g. the universal tray, are treated with PerfectClean enamel (see "Cleaning and care"). Surfaces treated with PerfectClean enamel generally do not need to be greased or covered with baking paper.

- Use baking paper when cooking:
 - lye mixtures because anything prepared using a lye containing sodium hydroxide can damage the PerfectClean surface
 - mixtures with a high egg white content, such as sponge, meringue and macaroons, as these can easily stick
 - puff pastry or strudel dough
 - frozen food on the rack
 - small items of frozen food such as oven chips or potato croquettes on the universal tray

Tips on baking

- Dark, matt tins are best for baking. Avoid using bright, thin-walled tins as they give an uneven or poor browning result. In certain unfavourable conditions, the food will not cook properly.
- Place cakes in rectangular tins on the rack with the longer side across the width of the oven for optimum heat distribution and even results.
- When cooking frozen food such as chips, croquettes, cakes, pizza and baguettes, select the medium temperature quoted on the manufacturer's packaging.
- If a range is specified for the cooking duration, check whether the food is cooked after the shortest duration. Stick a wooden skewer into the food. If it comes out clean without any batter/dough on it, the food is done.

Notes on the oven functions

You can find an overview of all the functions with their recommended values in “Main and sub-menus”.

Combi mode

This function uses a combination of oven heat and moisture. The addition of steam prevents the surface of the food from drying out. Bread, bread rolls and puff pastry have a shiny and crispy crust.

You can choose between different types of heating:

- Combi Fan Plus
- Combi Conventional
- Combi Grill

We recommend baking bread and bread rolls in several cooking stages: the shine is created during the first cooking stage thanks to the injection of steam (maximum moisture, low temperature). Browning takes place in the next cooking stage with high moisture and a high temperature. It is then dried with reduced moisture and a medium to high temperature.

Useful tip: Recipes and comprehensive cooking charts with information on functions, temperatures, moisture and cooking durations can be found in the Miele cookbook/recipe booklet “Bake, roast, steam”.

Baking

Automatic programmes

Follow the instructions in the display.

Fan Plus

Use this function if you are baking on multiple shelf levels at the same time.

You can use any type of baking tray made of heat-resistant material.

Because the fan distributes the heat around the oven compartment straight away, it allows you to use a lower temperature than you would with the Conventional Heat function.

Conventional Heat

Use this function for cooking traditional recipes. If using an older recipe or cookbook, set the oven temperature 10 °C lower than that recommended.

This will not change the cooking duration.

Only bake on one level. If you are making a tray bake, use level 3. If you are making a cake in a baking tin, select level 2.

Intensive Bake

This function is suitable for baking cakes with moist toppings, pizza, quiche, etc.

Place the food on shelf level 1.

Bottom Heat

Use this function towards the end of cooking to brown the base of the food.

Top Heat

Use this function towards the end of cooking to brown the top of food.

This function is suitable for gratins and for browning bakes.

Cake Plus

Use this function for baking creamed and frozen lye mixtures.

Eco Fan Heat

Use this function for cooking small amounts of food, e.g. frozen pizzas or biscuits, while saving energy.

Roasting tips

- Never roast frozen meat as it will dry out. Always defrost meat before roasting.
- Remove skin and sinew before roasting.
- Marinate and season the meat to taste.
- If you are roasting several pieces of meat together, select pieces that have a similar thickness.
- Use the universal tray with the rack placed on top of it. The oven compartment stays cleaner and you can then use the meat juices collected to make a gravy or sauce.



- Allow a standing time of approx. 10 minutes before carving meat. This resting time ensures the meat juices are distributed evenly.

Notes on the oven functions

You can find an overview of all the functions with their recommended values in “Main and sub-menus”.

Combi mode

This function uses a combination of oven heat and moisture. The addition of steam prevents the surface of the food from drying out. The results are particularly tender and succulent meat with a well-browned outside. Use the Combi mode  function for cooking meat, fish and poultry dishes.

You can choose between different types of heating:

- Combi Fan Plus
- Combi Conventional
- Combi Grill

We recommend cooking meat slowly and gently in several cooking stages: at a high temperature during the first cooking stage to brown the surface. The second cooking stage requires increased moisture and a reduced temperature. The meat cooks evenly and the muscle protein is macerated, making the meat particularly tender.

Useful tip: Recipes and comprehensive cooking charts with information on functions, temperatures, moisture and cooking durations can be found in the Miele cookbook/recipe booklet “Bake, roast, steam”.

Roasting

Automatic programmes

Follow the instructions in the display.

Fan Plus

This function is suitable for roasting meat and poultry that needs to be well browned.

Because the fan distributes the heat around the oven compartment straight away, it allows you to use a lower temperature than you would with the Conventional Heat function.

Conventional Heat

Use this function for cooking traditional recipes. If using an older recipe or cookbook, set the oven temperature 10 °C lower than that recommended. This will not change the cooking duration.

Use the Bottom Heat function towards the end of the cooking duration to brown the base of the food.

Do not use the Intensive Bake function for roasting as the juices will become too dark.

 Risk of injury caused by hot surfaces.

If you open the appliance door during grilling, the controls will get very hot.

Keep the door closed during the grilling programme.

Grilling tips

- Always pre-heat for at least 5 minutes before grilling.
- Use the universal tray with the rack placed on top of it.



- When grilling fish, place the fish on a piece of baking paper cut to size.
- Grill thick food, e.g. half a chicken, on level 2 or 3 and thin food, e.g. steaks, on level 4.
- Turn the food $\frac{2}{3}$ of the way through the cooking duration. Exception: It is not necessary to turn food when using Fan Grill or grilling fish.

Tips for grilling

- Marinate lean meat or brush it with oil. Do not use other types of fat as they can burn and cause smoke.
- Pierce sausages before grilling.
- It is best to grill food of a similar thickness at the same time so that the grilling time for each item does not vary too greatly.
- To **test the food**, press down on the meat with a spoon. This lets you determine how well the meat has been cooked.
 - **Rare**
If the meat gives easily to the pressure of the spoon, it will still be red on the inside.
 - **Medium**
If there is some resistance, the inside will be pink.
 - **Well-done**
If there is great resistance, it is cooked through.
- To grill thicker pieces of food more gradually after an initial high temperature, continue grilling at a lower temperature setting or use a lower shelf level to allow the food to cook through to the centre.

Grilling

Notes on the oven functions

You can find an overview of all the functions with their recommended values in “Main and sub-menus”.

Combi Grill

This function is suitable for grilling food that should be brown on the outside, but not dry, e.g. corn on the cob.

Full Grill

Use this function to grill flat thin cuts in large quantities and for browning large baked dishes.

Economy Grill

Use this function to grill flat thin cuts in smaller quantities and for browning small baked dishes.

Fan Grill

This function is suitable for grilling thicker food, such as poultry or rolled meat.

Grilling chart

Settings

Other  | Fan Grill

Temperature: see chart

Duration: see chart

The chart below is a suggested guide only. Temperatures are approximations and must be varied according to the thickness and preparation of the meat. Personal taste and size of serves will vary times and temperatures. We recommend you monitor cooking results for best outcomes.

Food	🔥 [°C]	 4 1	🕒 [min.]
Meat			
Chicken breast fillet	200	4	14–18
Chicken satays	200	4	12–15
Whole butterflied chicken	200	3	35–40
Kebabs and satays (red meat)	200	4	12–15
Lamb back straps	220	4	8–10
Lamb loin chops	190	4	12–16
Lean beef fillet steak	220	4	6–12
Lean thin sausages	180	4	8–10
Thick sausages	180	4	15–20
Fish			
Oily fish	200	4	8–12
Thick fish fillets, cutlets or steaks	200	4	10–15
Thin white fish fillets	220	4	6–10
Vegetables			
Potato wedges or small roast potatoes	220	3	20–25
Vegetables, capsicum, zucchini, sweet potato, eggplant	200	4	12–15

🔥 Temperature,  4 Shelf level, 🕒 Duration

Cleaning and care

Notes on cleaning and care

 Risk of injury caused by hot surfaces.

The steam oven gets hot during operation. You could burn yourself on the heating elements, oven compartment, shelf runners or accessories.

Allow the heating elements, oven compartment, shelf runners and the accessories to cool down before manual cleaning.

 Risk of injury due to electric shock.

The steam from a steam cleaning appliance could reach electrical components and cause a short circuit.

Do not use a steam cleaner to clean the steam oven.

The use of unsuitable cleaning agents can cause the surfaces to discolour or alter. The front of the steam oven is particularly susceptible to damage from oven cleaners and descaling agents.

All surfaces of this appliance are susceptible to scratching. Scratches on glass surfaces could cause a breakage in certain circumstances.

Remove any residual cleaning agent immediately.

Stubborn soiling could damage the steam oven in certain circumstances. Once the oven has cooled, clean the oven compartment, the inside of the door and the door seal. Waiting too long can make cleaning unnecessarily difficult and in some cases impossible.

Do not use commercial cleaning agents. Only use cleaning agents designed for domestic use.

Do not use cleaning agents or washing-up liquids containing aliphatic hydrocarbons as these could cause the seals to swell.

- The appliance and accessories should be cleaned and dried thoroughly after each use.
- Leave the appliance door open until the oven interior is completely dry.

If the steam oven is not going to be used for a longer period of time, it should be thoroughly cleaned and dried beforehand to prevent the build-up of odours and so on. Leave the door open afterwards.

Unsuitable cleaning agents

To avoid damaging the surfaces of your appliance, do not use:

- cleaning agents containing soda, alkalines, ammonia, acids or chlorides
- cleaning agents containing descaling agents
- abrasive cleaning agents, e.g. powder cleaners and cream cleaners
- solvent-based cleaning agents
- stainless steel cleaning agents
- dishwasher cleaners
- glass cleaning agents
- cleaning agents for ceramic cooktops
- hard, abrasive brushes or sponges, e.g. pot scourers, brushes or sponges which have been previously used with abrasive cleaning agents
- dirt eraser sponges
- sharp metal scrapers
- steel wool or metal scourers
- stainless steel spiral pads
- spot cleaning with mechanical cleaning agents
- oven cleaners and sprays

Cleaning the front

- Clean the appliance front with a clean, soft sponge and a solution of warm water and washing-up liquid.
- After cleaning, wipe the surfaces dry using a soft cloth.

Useful tip: A clean, damp microfibre cloth without cleaning agent can also be used.

Cleaning and care

PerfectClean

The oven compartment, shelf runners, universal tray and combi rack surfaces are **treated with PerfectClean enamel**. This finish has an iridescent appearance. PerfectClean surfaces have very good non-stick properties and are easy to clean.

However, it is important to clean the surfaces each time the oven is used. The non-stick properties will deteriorate if soiling is not removed from PerfectClean surfaces after each use. If used frequently without being cleaned, cleaning may become very difficult.

Soiling such as spilt juices and cake mixtures are best removed whilst the oven compartment is still warm.

Spilt fruit juices may cause discolouration to the surfaces that cannot be removed. However, this does not affect the properties of the PerfectClean finish.

Always remove all cleaning agent residues to protect the non-stick properties.

To protect the non-stick effect of PerfectClean surfaces, please avoid:

- abrasive cleaning agents, e.g. powder cleaners and cream cleaners
- cleaning agents for ceramic cooktops
- ceramic glass and stainless steel cleaners
- steel wool or metal scourers
- abrasive sponges, e.g. pot scourers or sponges which have been previously used with abrasive cleaning agents
- oven sprays
- spot cleaning with mechanical cleaning agents

Do **not** clean PerfectClean accessories in the dishwasher.

Oven compartment

The surface of the oven compartment has been treated with PerfectClean.

Please see “Cleaning and care - PerfectClean” for instructions on cleaning.

Ensure that no cleaning agent gets into the openings on the oven compartment rear panel.

To make cleaning the oven compartment easier, you can remove the oven door, dismantle the shelf runners and lower the top heat/grill element.

Cleaning after a programme using steam

- Remove:
 - condensate using a sponge or absorbent cloth,
 - light, greasy soiling with a sponge and a solution of washing-up liquid and hot water.
- After cleaning, wipe the surface with clean water to remove any cleaning agent residues.
- Then dry the oven compartment and the inside of the door with a cloth.

Useful tip: You can then dry the oven compartment automatically using the Drying maintenance programme (see "Maintenance").

Cleaning after a roasting, grilling or baking programme

Clean the oven compartment thoroughly after roasting, grilling and baking as otherwise soiling can burn on and become impossible to remove.

- Clean the oven compartment and inside of the door with a clean washing-up sponge, hot water and a little washing-up liquid. You can use the hard surface of a washing-up sponge to clean the oven compartment if necessary.
- After cleaning, wipe the surface with clean water to remove any cleaning agent residues.
- Then dry the oven compartment and the inside of the door with a cloth.

Useful tip: Soaking the soiling for a few minutes with a solution of washing-up liquid and hot water can make cleaning easier. Alternatively, run the Other  | Maintenance | Soak programme (see “Cleaning and care - Maintenance”).

Cleaning and care

Cleaning the floor filter

- The filter in the floor of the oven should be cleaned and dried after every use.
- Vinegar can be used to remove discolouration and limescale deposits from the filter in the floor of the oven. Rinse thoroughly with clean water afterwards.

Cleaning the door seal

The door seal may become brittle and tear on account of contact with grease residues.

Clean the door seal between the inside of the oven door and the oven compartment after every baking or roasting programme.

- Clean the door seal using a clean, damp microfibre cloth without any cleaning agent. You can also use a clean sponge and warm water with a little washing-up liquid.
- After cleaning, dry the seal with a soft cloth.
- Replace the seal with a new one if it becomes porous or brittle.

Door seals can be ordered from Miele (see the end of this booklet for contact details).

Cleaning the water container and condensate container

The water container and condensate container are suitable for cleaning in a dishwasher.

- Remove the water container and condensate container after every use. Remove the water container and condensate container by pushing them upwards slightly as you take them out of the appliance.
- Empty the water container and condensate container.

Water can drip into the water container and condensate container compartment when removing the containers.

- Dry the compartment if necessary.
- Rinse the water container and condensate container by hand or in the dishwasher.
- Then dry the water container and condensate container with a soft cloth to prevent limescale.

Accessories

Cleaning the universal tray and combi rack

The surfaces of the universal tray and the combi rack have been treated with PerfectClean. Please see “Cleaning and care - PerfectClean” for instructions on cleaning.

- Remove:
 - light soiling with a clean sponge and a solution of washing-up liquid and warm water.
 - stubborn soiling with a clean washing-up sponge, hot water and a little washing-up liquid. If necessary, you can also use the rough side of the sponge.
- After cleaning, wipe the surface with clean water to remove any cleaning agent residues.
- Then wipe the surfaces dry using a cloth.

Cleaning cooking containers

The cooking containers are suitable for cleaning in the dishwasher.

- Wash and dry the cooking containers after each use.
- Any bluish discolouration on cooking containers can be removed with vinegar. Rinse with clean water.

Cleaning and care

Cleaning the shelf runners

The surfaces of the shelf runners have been treated with PerfectClean. Please see “Cleaning and care - PerfectClean” for instructions on cleaning.

 Risk of injury caused by hot surfaces.

The steam oven gets hot during operation. You could burn yourself on the heating elements, the oven compartment, or accessories.

Allow the heating elements, oven compartment and the accessories to cool before removing the shelf runners.

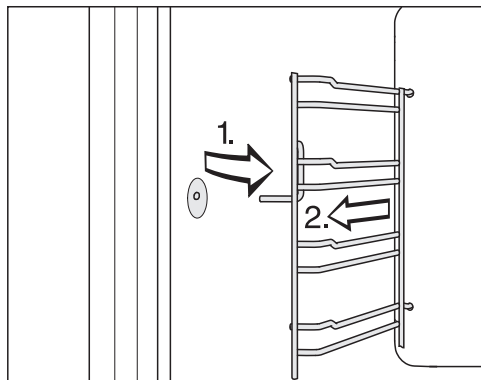

- Pull the shelf runners out of the holder (1.) at the front of the oven and then pull them out of the oven (2.).

- Remove:

- light soiling with a clean sponge and a solution of washing-up liquid and warm water.
- stubborn soiling with a clean washing-up sponge, hot water and a little washing-up liquid. If necessary, you can also use the rough side of the sponge.

- After cleaning, wipe the surface with clean water to remove any cleaning agent residues.

- Then dry the shelf runners with a cloth.

Refit in the reverse order.

- Refit the shelf runners carefully.

If the shelf runners are not correctly inserted, there is no anti-tip protection. The temperature sensor could also be damaged when cooking containers are placed in the steam oven.

Lowering the top heat/grill element

If the oven compartment roof is badly soiled, the top heat/grill element can be lowered by approx. 5 cm to make cleaning easier.

 Risk of injury caused by hot surfaces.

The steam oven gets hot during operation. You could burn yourself on the heating elements, oven compartment, shelf runners or accessories.

Allow the heating element, oven compartment, shelf runners and the accessories to cool before cleaning.

Use caution not to damage the top heat/grill element.

Never use force when pulling down the top heat/grill element.

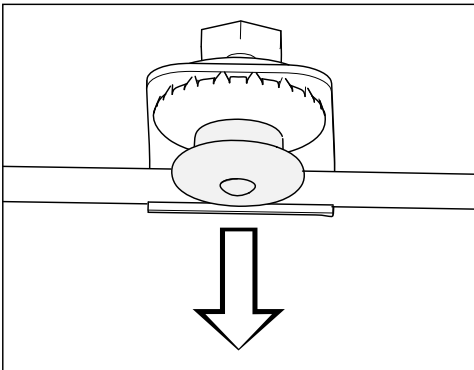

- Carefully pull down the pressure cap. The top heat/grill element then lowers automatically.

- Clean the oven compartment roof with a sponge cloth or a washing-up sponge (see “Cleaning and care - Oven compartment”).
- After cleaning the oven compartment roof, push the pressure cap back up. Make sure the pressure cap engages correctly.

Cleaning and care

Maintenance

The Finish at and Start at functions are not available in maintenance programmes.

Soaking

Stubborn soiling can be soaked using this maintenance programme.

- Let the oven compartment cool down.
- Take all accessories out of the oven compartment.
- Remove coarse soiling with a cloth.
- Select Other  | Maintenance | Soak.

The soaking process takes approx. 10 minutes.

Drying

This maintenance programme can be used to dry any residual moisture in the oven compartment, including in inaccessible areas.

- Dry the oven compartment with a soft cloth first.
- Select Other  | Maintenance | Drying.

The drying process takes approx. 20 minutes.

Rinsing

The water-carrying system is rinsed out during this maintenance programme. Any remaining food deposits are rinsed away.

- Select Other  | Maintenance | Rinse.
- Follow the instructions in the display.

The rinsing process takes approx. 10 minutes.

Descaling the steam oven

We recommend using Miele descaling tablets (see “Optional accessories”) to descale the appliance. These have been specially developed for use with Miele appliances to optimise the descaling process. Other descaling agents, which contain other acids besides citric acid and/or other undesirable substances, such as chlorides, could cause damage to the product. Moreover, the descaling result required could not be guaranteed if the descaling solution was not of the appropriate concentration.

Do not spill descaling agent onto metal surfaces. This can cause marks to appear.

However, should any descaling agent get onto these surfaces, wipe it away immediately.

The steam oven has to be descaled after a certain number of operating hours. When the time comes to descale it, the number of uses remaining lights up in the display. Only cooking processes that use steam are counted. The appliance will lock after the last remaining cooking process.

We recommend that you descale the appliance before it locks out.

During the descaling process, the water container must be rinsed out and refilled with fresh water. The condensate container needs to be emptied.

- Switch the steam oven on and select **Descal** .

The message **Please wait** will appear in the display. The descaling process is being prepared. This may take several minutes. As soon as the appliance is ready, you will be prompted to fill the water container.

- Fill the water container with lukewarm fresh tap water up to the level marker  and drop 2 Miele descaling tablets in it.
- Wait until the descaling tablets have dissolved.
- Push the water container into the appliance.
- Confirm with **OK**.
- Empty the condensate container.
- Confirm with **OK**.

The time remaining will appear in the display. The descaling process will now begin.

Do not switch the steam oven off during the descaling process, otherwise the whole process will have to be started from the beginning again.

During the course of the descaling process, the water container needs to be rinsed and filled with fresh water twice. The condensate container needs to be emptied.

- Follow the instructions in the display.
- Confirm each with **OK**.

Once the time left has elapsed, **Empty the condensate container** will appear in the display.

- Follow the instructions in the display.
- Confirm with **OK**.

The descaling process is complete.

- Remove the water container and condensate container and empty them as required.
- Clean and dry the water container and condensate container.
- Switch the steam oven off.
- Open the door and let the oven cool down.
- Then dry the oven compartment.
- Leave the appliance door open until the oven interior is completely dry.

Cleaning and care

Removing the door

- Prepare a suitable underlay for the door, such as a soft cloth.
- Open the door a fraction.

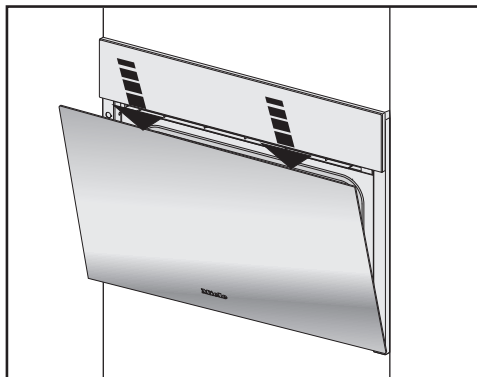

- Using both hands, press down on the top edge of the door briefly.

The oven door is connected to the hinges by retainers. Before removing the door from the retainers, the locking clamps on both door hinges have to be released.



- Open the door fully.

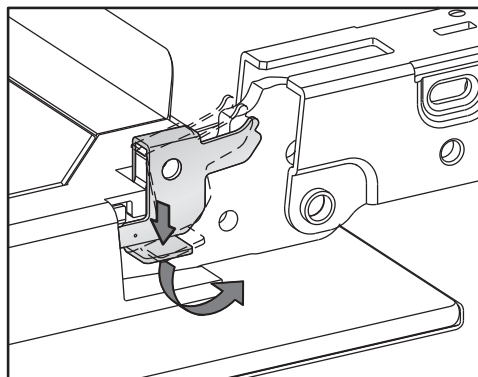

- Release the locking clamps on the hinges by pushing them down as far as they will go until they are at an angle.

The steam oven could become damaged if you incorrectly remove the door.

Never pull the door horizontally off its retainers, as they will spring back against the steam oven.

Do not pull the door off the retainers by the handle, as the handle could break off.

- Raise the door up until it rests partially open.



- Hold the door on either side and evenly pull diagonally upwards from the hinge retainers. Make sure that the door is straight.
- Place the door on the previously prepared surface.

Fitting the door

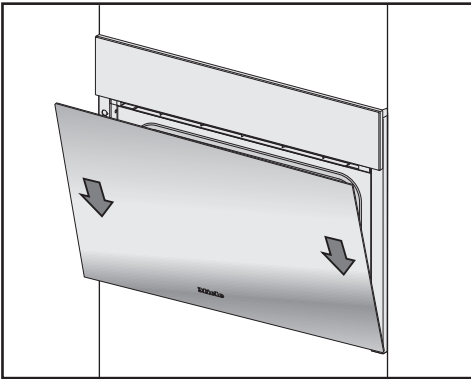

- Hold the door securely on both sides and carefully fit it back onto the door hinge retainers. Make sure that you put the door back on straight.
- Open the door fully.

If the locking clamps are not locked, the door could work loose, resulting in damage.

Ensure that the locking clamps are locked after refitting the door.

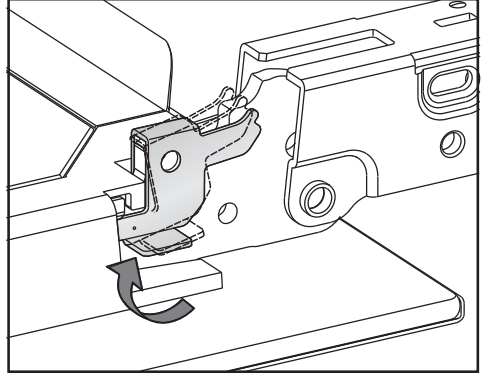

- To relock the locking clamps, flip them back up to the horizontal position as far as they will go.

Problem solving guide

Many malfunctions and minor faults that can occur in daily operation can be corrected without contacting Miele. This will save you time and money because you will not need a service call.

You can find information on how to remedy faults yourself at www.miele.com/service.

Please note, however, that a call-out charge will be applied to unnecessary service visits where the problem could have been rectified as described in these operating instructions.

Messages in the display

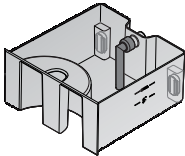
Problem	Possible cause and remedy
F10	<p>The suction hose in the water container is not inserted correctly, or is not vertical.</p> <ul style="list-style-type: none">■ Correct the position of the suction hose: 
F11 F20	<p>Internal drainage fault.</p> <ul style="list-style-type: none">■ Descale the steam oven (see “Cleaning and care - Maintenance”).■ If the fault message appears again, contact Miele.
F44	<p>There is a fault.</p> <ul style="list-style-type: none">■ Switch the steam oven off and then back on again after a few minutes.■ If the same message appears again, contact Miele.
F55	<p>The maximum length of time for which the steam oven can be operated on a function has been exceeded, so the appliance has switched itself off automatically for safety reasons.</p> <ul style="list-style-type: none">■ Switch the steam oven off and then back on again. <p>The steam oven is immediately ready for use again.</p>

Problem solving guide

Problem	Possible cause and remedy
F196	<p>There is a fault.</p> <ul style="list-style-type: none">■ Switch the steam oven off and then back on again. <p>The floor filter is not fitted correctly.</p> <ul style="list-style-type: none">■ Switch the steam oven off. <div style="text-align: center;"></div> <ul style="list-style-type: none">■ Insert the filter correctly:■ Switch the steam oven back on again.■ If the same message appears again, call Miele.
The display shows a message not listed in this table.	<p>There is an electronic unit fault.</p> <ul style="list-style-type: none">■ Disconnect the power supply to the steam oven for approx. 1 minute.■ If the problem persists after power is restored, please contact Miele.

Problem solving guide

Unexpected behaviour

Problem	Possible cause and remedy
The oven compartment does not heat up.	Demo mode is active. The steam oven can be operated, however the heating elements will not work. ■ Deactivate Demo mode (see "Settings - Showroom programme").
	The oven compartment has been warmed up by a warming drawer in operation underneath it. ■ Open the door and let the oven compartment cool down.
After moving house, the appliance no longer switches from the heating-up phase to the cooking phase.	Altitude affects the boiling point of water. If you move house, the appliance will need to be reset for the new altitude if this differs from the old one by more than 300 m. ■ To adjust the boiling temperature, you need to descale the appliance (see "Cleaning and care – Maintenance").
During operation an unusually large amount of steam escapes or steam escapes from parts of the steam oven where it does not usually.	The door is not properly closed. ■ Close the door.
	The door seal is not correctly fitted. ■ If necessary, press it in all the way round the door to make sure it is fitted evenly.
	The door seal is damaged, e.g. cracked. ■ Replace the door seal. This can be ordered from Miele (see the end of this booklet for contact details).
The Start at and Finish at functions are not available.	The temperature in the oven compartment is too high, e.g. after a programme has finished. ■ Open the door and let the oven cool down.
	These functions are not generally available in maintenance programmes.

Problem solving guide

Problem	Possible cause and remedy
The sensors do not respond.	<p>You have selected the Display QuickTouch Off setting. Therefore, when the steam oven is switched off, the sensors do not respond.</p> <ul style="list-style-type: none">■ As soon as the steam oven is switched on, the sensors will respond. If you want the sensors to always respond even when the steam oven is switched off, select the Display QuickTouch On setting.
	<p>The steam oven is not connected to the power supply.</p> <ul style="list-style-type: none">■ Check that the steam oven power plug is correctly inserted into the socket.■ Check if the circuit breaker has tripped. Contact a qualified electrician or Miele.
	<p>There is a fault with the controls.</p> <ul style="list-style-type: none">■ Touch and hold the On/Off  sensor until the display switches off and the steam oven restarts.

Problem solving guide

Noises

Problem	Possible cause and remedy
A humming sound can be heard during operation and after switching off the steam oven.	This noise does not indicate incorrect operation or an appliance fault. The noise is made by water being pumped through the system.
The fan can still be heard after the appliance has been switched off.	The fan is still running. The appliance is fitted with a fan which removes steam from the oven. The fan will continue to run for a while after the appliance has been switched off. It will switch itself off automatically after a while.

Unsatisfactory results

Problem	Possible cause and remedy
Cakes and biscuits are not cooked properly after following the durations given in the recipe.	The temperature set is not the same as the one given in the recipe. ■ Change the temperature.
	The recipe has been altered. For example, adding more liquid or eggs can increase the cooking duration required. ■ Adapt the temperature and/or cooking duration to the altered recipe.
Cakes or biscuits are unevenly browned.	The temperature was set too high.
	More than two shelf levels were used for baking. ■ Bake on a maximum of two levels.

General problems or technical faults

Problem	Possible cause and remedy
<p>You cannot switch the appliance on.</p>	<p>The circuit breaker has tripped.</p> <ul style="list-style-type: none"> ■ Reset the circuit breaker in the mains fuse box (see data plate for minimum fuse rating). <hr/> <p>There may be a technical fault.</p> <ul style="list-style-type: none"> ■ Disconnect the appliance from the mains connection for approximately 1 minute by: <ul style="list-style-type: none"> – switching off at the wall socket and withdrawing the plug, or – switching off the mains circuit breaker or residual current device. ■ If, after switching the circuit breaker or residual current device back on, the steam oven will still not switch on, contact a qualified electrician or Miele.
<p>The oven lighting doesn't come on.</p>	<p>The lamps need to be replaced.</p> <ul style="list-style-type: none"> ■ Call Miele to have the lamps replaced.
<p>The control panel will not open or close automatically despite tapping the  sensor several times.</p>	<p>Something is obstructing the control panel.</p> <ul style="list-style-type: none"> ■ Remove the obstruction. <hr/> <p>The obstruction sensor is very sensitive, which means the control panel sometimes does not open or close.</p> <ul style="list-style-type: none"> ■ Open/Close the control panel manually (see end of this section). ■ If the problem occurs frequently, contact Miele.

Problem solving guide

Opening the control panel manually

- Carefully open the appliance door.

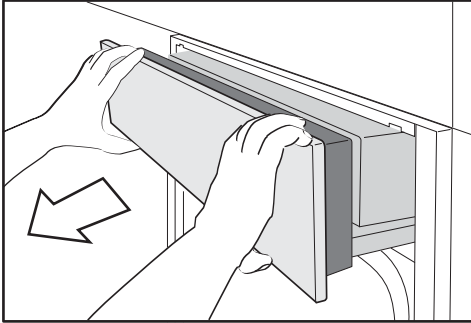

- Hold the control panel at the top and bottom.
- Pull out the panel towards you.
- Carefully push it upwards.

Closing the control panel manually

- Hold the control panel at the top and bottom.
- Carefully push it downwards.

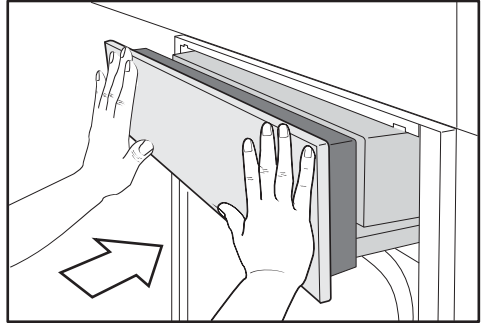

- Push the panel right in.

Miele offers a range of useful accessories, as well as cleaning and conditioning products for your appliance.

These products can be ordered from the Miele online shop.

They can also be ordered directly from Miele (see end of this booklet for contact details).

Cooking containers

Miele offers a wide range of cooking containers. These have all been optimised in terms of functionality and dimensions for Miele appliances. Detailed information on each of our products can be found on the Miele website.

- Perforated cooking containers in various sizes
- Solid cooking containers in various sizes
- Gourmet oven dishes in various sizes
- Lids for Gourmet oven dishes

Other

- Baking trays
- Round baking tray
- FlexiClip telescopic runners HFC 71
- Container rack for cooking containers with a width of 325 mm

Cleaning and care products

- DGClean
Special cleaning agent for removing stubborn soiling from the oven compartment, particularly after roasting
- Descaling tablets
- All purpose microfibre cloth
For removing finger marks and light soiling

Service

You can find information on how to remedy faults yourself and about Miele spare parts at www.miele.com/service.

Contact in case of fault

In the event of any faults which you cannot remedy yourself, please contact Miele.

You can book a Miele customer service call-out online at www.miele.com.au/service or www.miele.co.nz/service.

Contact information for Miele can be found at the end of this booklet.

Please quote the model and serial number of your appliance when contacting Miele. This information can be found on the data plate.

When installed, you will find the model code and serial number on the small plate on top of the opened control panel.

Warranty

The manufacturer's warranty for this appliance is 2 years.

For further information, please refer to your warranty booklet.

Safety instructions for installation

 Risk of damage from incorrect installation.

Incorrect installation can cause damage to the steam oven.

The steam oven must only be installed by a qualified person.

- ▶ The connection data (frequency and voltage) on the steam oven's data plate must correspond with those of the electricity supply in order to ensure that no damage can occur to the steam oven. Compare this data before connecting the appliance. If in any doubt, consult a qualified electrician.
- ▶ Multi-socket adapters and extension leads do not guarantee the required safety of the appliance (fire hazard). Do not use them to connect the steam oven to the power supply.
- ▶ The socket and on-off switch should be easily accessible after the steam oven has been installed.
- ▶ The steam oven must be positioned so that you can see the contents of a cooking container placed on the top shelf level. Otherwise there is a risk of injuries or spillages of hot food.

Installation

Installation dimensions

All dimensions are given in mm.

Installation in a tall unit

The furniture housing unit must not have a back panel fitted behind the building-in niche.

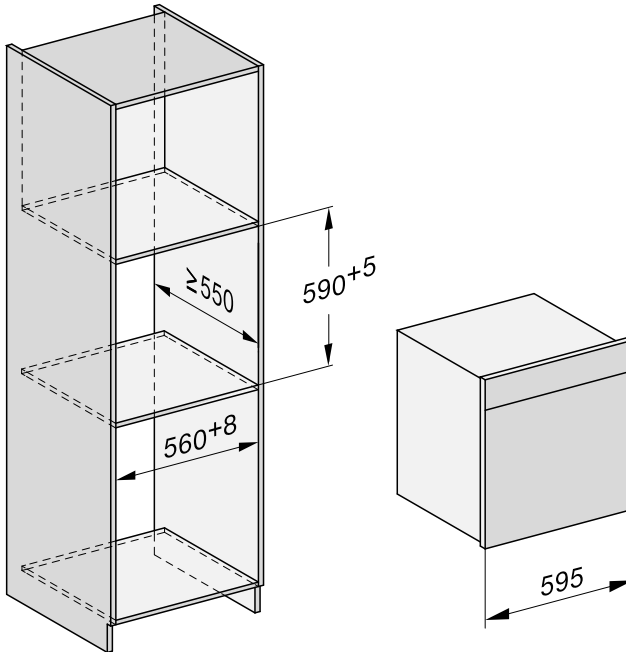

Installation in a base unit

The furniture housing unit must not have a back panel fitted behind the building-in niche.

When building the oven into a base unit underneath a cooktop, please also observe the installation instructions for the cooktop as well as the building-in height required for the cooktop.

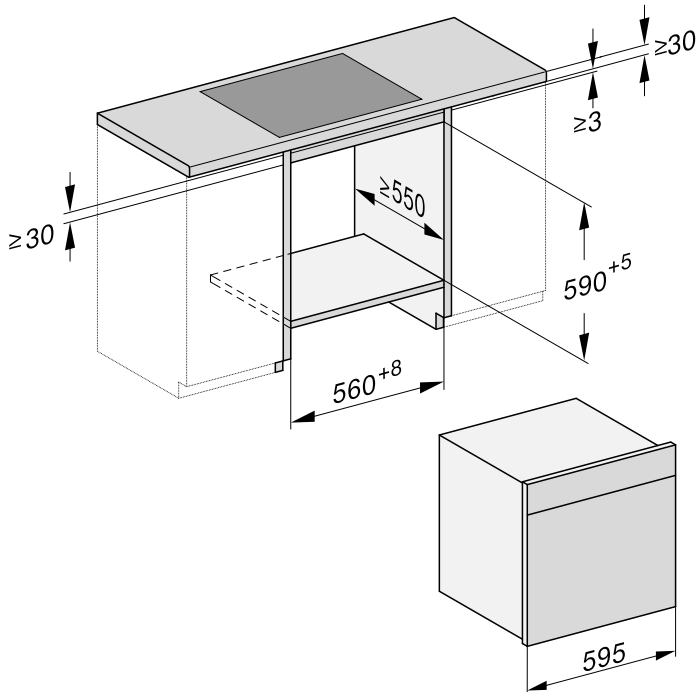

Installation

Side view

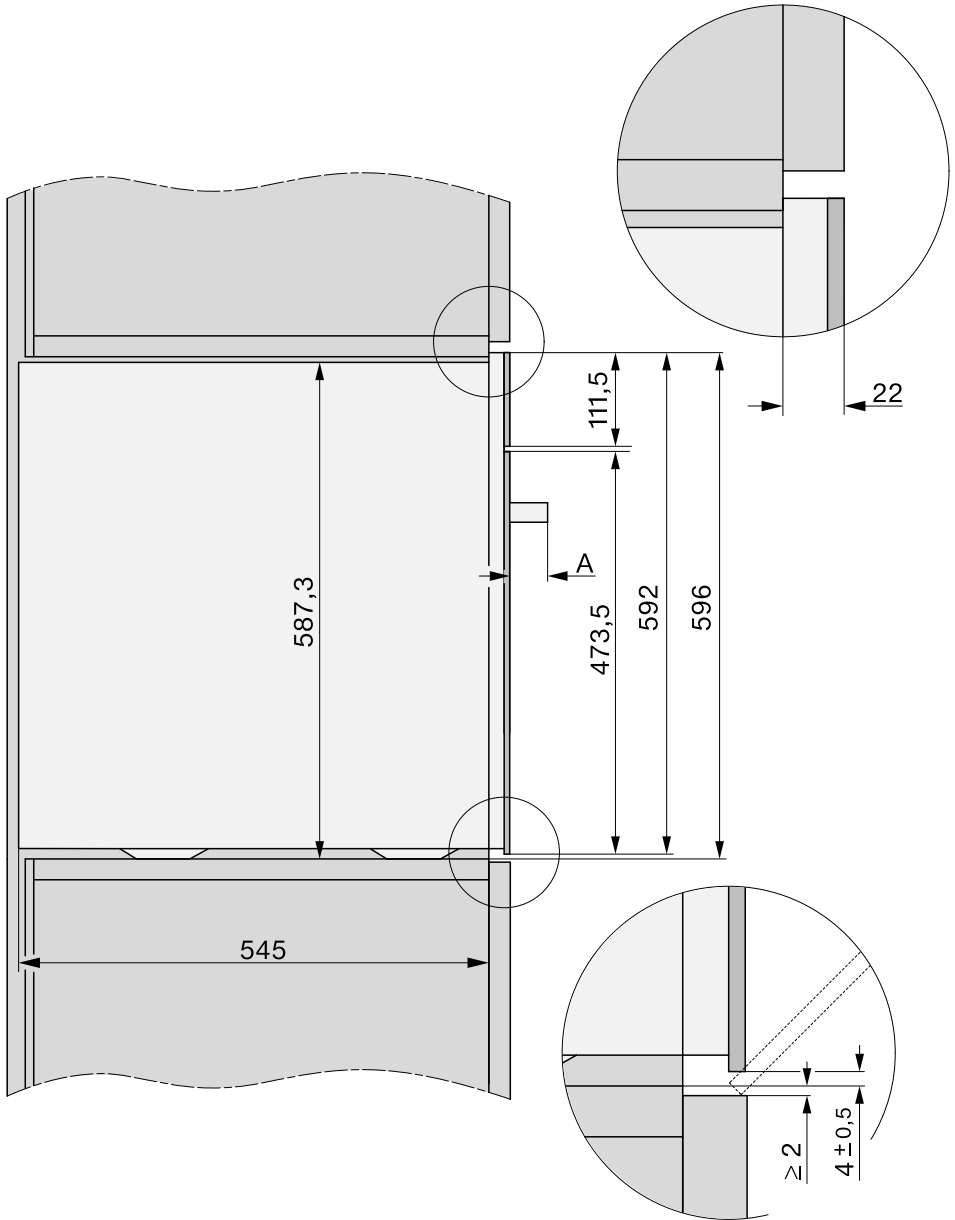

A DGC 74xx: 47 mm

Room for the control panel to open and close

The area in front of the control panel must not be blocked by anything (such as a door handle) that would hinder it from opening and closing.

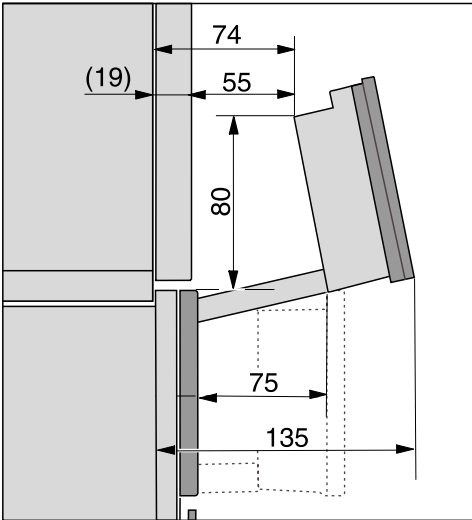

Installation

Connection and ventilation

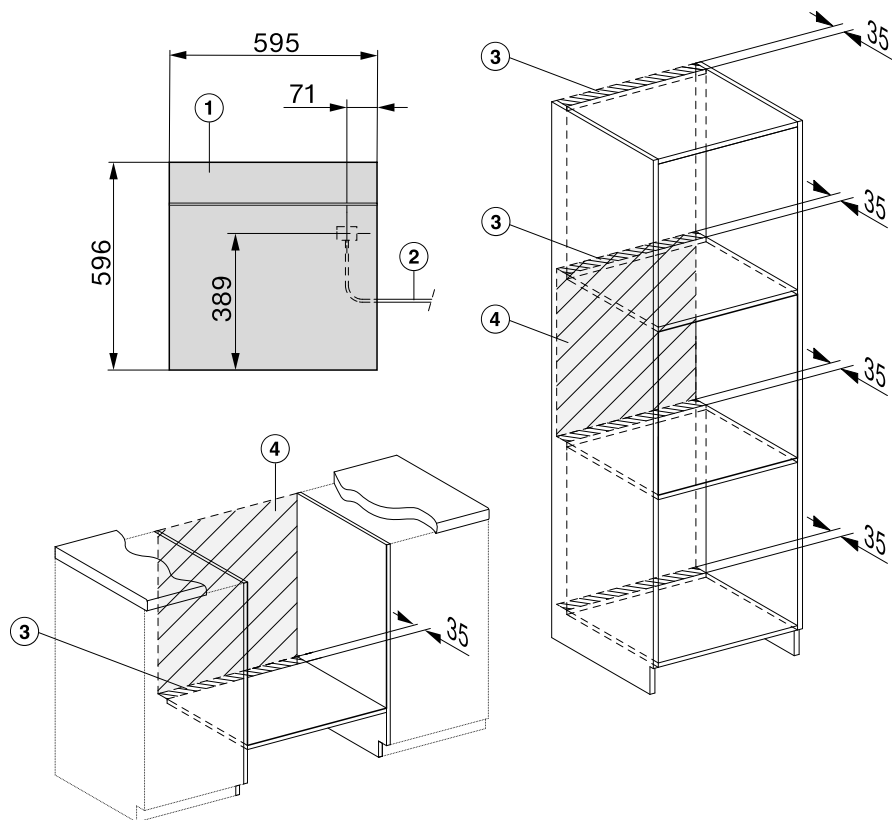

- ① Front view
- ② Mains connection cable, L = 2000 mm
- ③ Ventilation cut-out, min. 180 cm²
- ④ No connections permitted in this area

Installing the steam oven

- Connect the mains connection cable to the appliance.

Risk of damage from incorrect transportation.

Lifting the steam oven by the door handle could cause damage to the door.

Use the handle cut-outs on the side of the casing to lift the appliance.

The steam generator may malfunction if the steam oven is not on a level surface.

The maximum deviation from the horizontal that can be tolerated is 2°.

- Push the steam oven into the installation niche and align.
When doing so, make sure that the mains connection cable does not get trapped or damaged.
- Open the door.

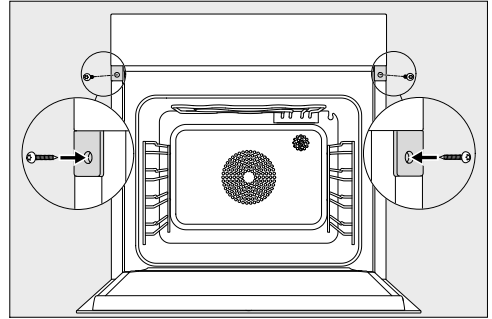

- Secure the steam oven to the side walls of the unit using the wood screws supplied (3.5 x 25 mm).
- Connect the appliance to the mains electricity supply.
- Check the appliance for correct function in accordance with the operating instructions.

Installation

Electrical connection

The steam oven is supplied with a mains connection cable with moulded plug ready for connection to a suitable earthed socket.

The socket should be easily accessible after the steam oven has been installed. If the socket is not easily accessible, ensure that a suitable means of disconnection is provided on the installation side for each pole.



Risk of fire from overheating.
Connecting the steam oven to multi-socket adapters or extension cables can overload the cables.
For safety reasons, do not use an extension cable or multi-socket adapter.

Risk of damage from incorrect connection. Incorrect installation, maintenance and repairs can be dangerous to users.
Miele cannot be held liable for damage or injury (e.g. electric shock) caused by unauthorised installation, maintenance or repair work, or by an inadequate or faulty on-site earthing system.

All electrical work must be carried out by a suitably qualified and competent person in strict accordance with national and local safety regulations.

For safety reasons, we recommend using a suitable residual current device (RCD) in the relevant electrical installation for connecting the steam oven.

If the mains connection cable is damaged, it must only be replaced with a specific mains connection cable of the same type (available from Miele). For safety reasons, such replacement may only be carried out by a suitably qualified and competent electrician or a Miele authorised service technician, in order to avoid a hazard.

The data plate indicates the nominal power consumption and the connection data. Compare this information with the data of the on-site electrical connection.

If in any doubt, consult a qualified electrician.

Temporary or permanent operation with a self-sufficient or non-mains synchronous energy supply system (e.g. isolated networks, back-up systems) is possible. A requirement for the operation is that the energy supply system complies with all current local and national requirements that apply to stand-alone, solar and/or battery systems.

The protective measures provided in the domestic installation and in this Miele product must also be assured in their function and operation in isolated operation or in non-mains synchronous operation, or replaced with equivalent measures in the installation.

Copyright and licences for the communication module

For the purpose of operating and controlling the communication module, Miele uses proprietary or third-party software that is not covered by open source licensing terms. These items of software/software components are protected by copyright. The copyright powers of Miele and third parties must be respected.

In addition, the communication module contains software components which are distributed under open source licensing terms. The open source components contained in the appliance along with the corresponding copyright notices, copies of the licensing terms valid at the time, and any further information can be accessed locally via IP using a web browser (*http://<IP address>/Licenses*), where <IP address> is the IP address of the appliance. The liability and warranty arrangements for the open source licences displayed in this location only apply in relation to the respective rights holders.

Miele Australia Pty. Ltd.

ACN 005 635 398
ABN 96 005 635 398

Miele Head Office Melbourne:

Level 4, 141 Camberwell Road
Hawthorn East, VIC 3123

Miele Experience Centre Doncaster:

1136/7 Doncaster Shopping Centre
619 Doncaster Rd, Doncaster, VIC 3108

Miele Experience Centre South Melbourne:

206-210 Coventry Street
South Melbourne, VIC 3205

Miele Experience Centre and Office Sydney:

3 Skyline Place
Frenchs Forest, NSW 2086

Miele Experience Centre and Office Brisbane:

Tenancy 4C, 63 Skyring Terrace
Newstead, QLD 4006

Miele Experience Centre Gold Coast:

131 Ferry Road
Southport, QLD 4215

Miele Experience Centre and Office Adelaide:

83-85 Sir Donald Bradman Drive
Hilton, SA 5033

Miele Experience Centre and Office Perth:

205-207 Stirling Highway
Claremont, WA 6010

1300 464 353 (1300 4 MIELE)

www.miele.com.au

Miele New Zealand Limited

IRD 98 463 631

**Miele Experience Centre
and Head Office Auckland:**

8 College Hill
Freemans Bay, Auckland 1011

**Miele Experience Centre
Wellington:**

183 Featherston Street
Wellington 6011

0800 464 353 (0800 4 MIELE)

www.miele.co.nz

**Miele Global Headquarters
Germany**

Miele & Cie. KG

Carl-Miele-Straße 29
33332 Gütersloh
Federal Republic of Germany

DGC 7460

en-AU, NZ

M.-Nr. 11 218 720 / 02