

Miele

Quick Start Guide



for dishwashers

These short instructions are not a substitute for the operating instructions supplied with the machine.

It is essential to familiarise yourself with the dishwasher before using it for the first time. Take note of the Warning and Safety instructions, as well as the full descriptions on how to use your appliance.

en-AU, NZ

M.-Nr. 11 697 370 / 02

Guide to the appliance

Control panel

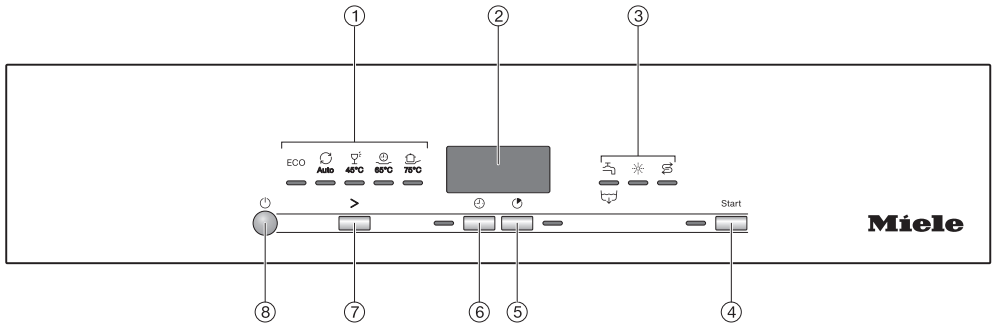

① Programme selection

- ECO = ECO
- Auto = Auto 45–65 °C
- 45 °C = Gentle 45 °C
- 65 °C = QuickPowerWash 65 °C
- 75 °C = Intensive 75 °C

② Time display

③ Check/Refill indicators

- Inlet / Drain
- Rinse aid
- Salt

④ Start button with indicator light

For starting the selected programme.

⑤ Express button

For reducing the programme duration.

⑥ Timer button

For selecting a later programme start.

⑦ Programme selection button >

For programme selection.

⑧ On/Off button

For switching the dishwasher on and off.

Brief instructions

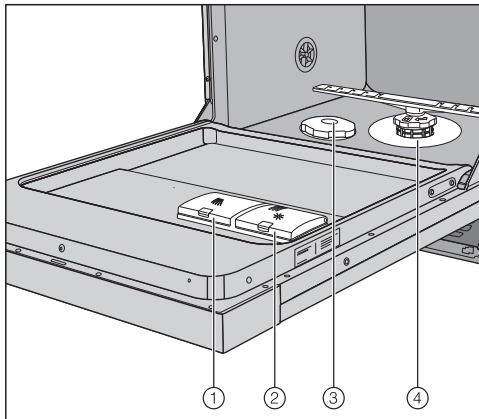

- ① Detergent compartment
- ② Rinse aid reservoir
- ③ Salt reservoir
- ④ Filter combination

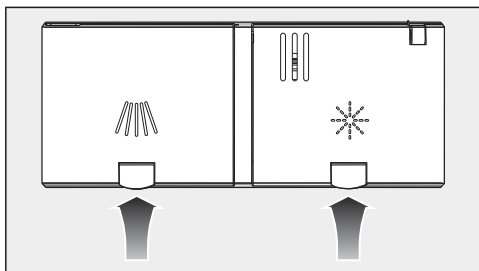



① Filling the salt reservoir (depending on water hardness)

- Remove the lower basket from the wash cabinet and unscrew the salt reservoir cap.

 **Damage to the water softener from detergents.**
Dishwasher detergent will damage the water softener.
Do not fill the salt reservoir with powder or liquid detergent.

 **Risk of corrosion due to saline solution.**

Water or saline solution will run out of the reservoir when the cap is opened. Saline solution that runs out can cause corrosion in the wash cabinet and to the dishwasher load. The salt reservoir should therefore only be opened to replenish the salt.

- Fill the salt reservoir with approx. 2 l of water (first use only).
- Place the funnel provided over the salt reservoir and carefully fill with dishwasher salt until the reservoir is full.
- Clean any excess salt from around the reservoir opening and then screw the salt reservoir cap on again firmly.
- Immediately after filling the salt container, run the *QuickPowerWash*  65 °C programme with the  *Express* option and without any load in the dishwasher to dissolve and remove any traces of salt from the cabinet.

② Adding rinse aid

- Lift the yellow button on the lid of the rinse aid container .
- Only fill with rinse aid until the fill level indicator turns dark when the door is open horizontally.
- Close the lid making sure it clicks into place.
- Wipe up any spilled rinse aid. This prevents over-foaming occurring during the next programme.

3 Loading the dishwasher

4 Adding detergent

- Follow the detergent dosage recommended by the manufacturer on the packaging.
- Lift the yellow catch on the lid of the detergent compartment .

The lid will be open at the end of the programme.

- Fill the detergent compartment with detergent and push the lid shut until you hear it click into place.

5 Switching on

- Close the door.
- Turn on the tap if it is turned off.
- Press the  button.

6 Selecting a programme

- Use the programme selection button to select the programme you want.

7 Select the Express programme option (if required)

Select the Express programme option using the  button.

The selected programme option will remain active for that particular programme until the setting is changed.

- Press the  button.

The  indicator will light up.

8 Activating the timer (if required)

- Press the  button.

- Set the required time after which the programme should start automatically using the  button and confirm with *Start*.

9 Starting a programme

- Press the *Start* button.

10 Programme end - Switching off

The programme has ended when  appears in the display.

The drying fan may continue to run for a few minutes at the end of the programme.

- The dishwasher can be switched off at any time using the  button.

 Risk of damage due to steam. Steam from the dishwasher could damage the edges of delicate worktops when you open the door at the end of the programme if the fan is no longer running. At the end of a programme, you can either open the door fully (do not leave it partially open) or leave it closed until you are ready to unload the crockery.

11 Unloading the dishwasher

Dishes tend to break and chip more easily when they are hot. Allow the dishes to cool until they are comfortable enough to handle before unloading them.

Cleaning and care

Cleaning the spray arms

Particles of food can get stuck in the spray arm jets and bearings. The spray arms should therefore be inspected regularly (approx. every 2–4 months).

⚠ Do not run a wash programme without the lower spray arm or without the filters fitted.

- Switch the dishwasher off.
- Take out the cutlery tray (if your dishwasher is fitted with one).
- Push the upper spray arm upwards to engage the inner ratchet. Then unscrew the spray arm by rotating the screw thread anti-clockwise (overhead perspective).

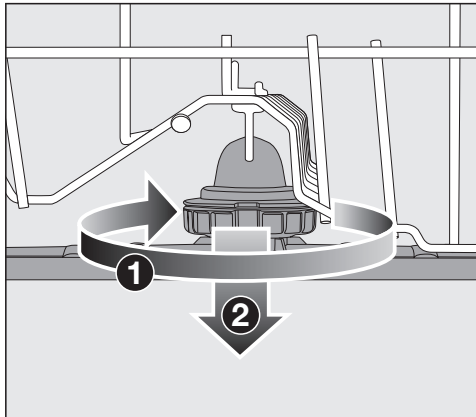

- Rotate the screw thread of the middle spray arm clockwise (overhead perspective) ① (see diagram) and remove the spray arm ②.
- Remove the lower basket.

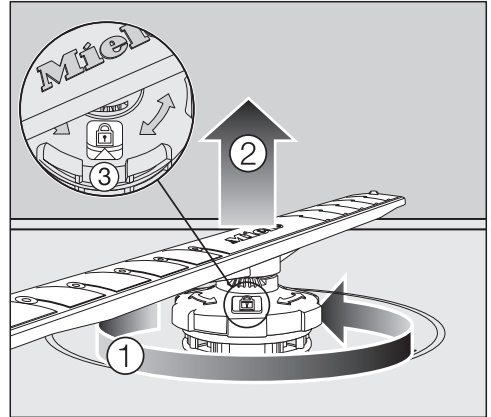

- Rotate the screw thread of the lower spray arm anti-clockwise ① and pull the spray arm upwards to remove ②.
- Use a pointed object to push food particles stuck in the jets into the spray arm.
- Rinse the spray arm thoroughly under running water.
- Refit the upper and middle spray arms.
- Refit the lower spray arm and ensure that the filter combination lies flat in the base of the wash cabinet.
- Rotate the screw thread of the lower spray arm clockwise until the arrow in the viewing window points ③ to the lock symbol .
- Make sure the spray arms can rotate freely.

Checking the filters in the wash cabinet

 Do not run a wash programme without the filters or without the lower spray arm fitted.

- Monitor the condition of the filter combination regularly and clean it if necessary.

Cleaning the filters

- Switch the dishwasher off.
- Remove the lower spray arm.
- Before removing the filter combination, remove any coarse soiling to prevent it from entering the circulation system.

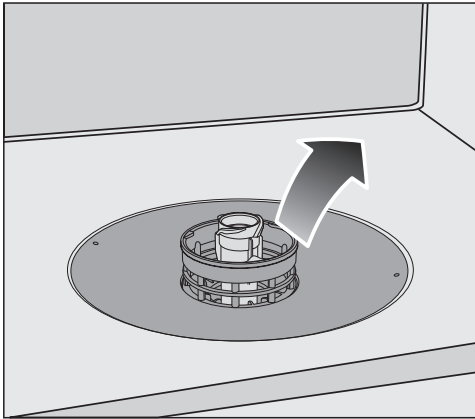

- Remove the filter combination.

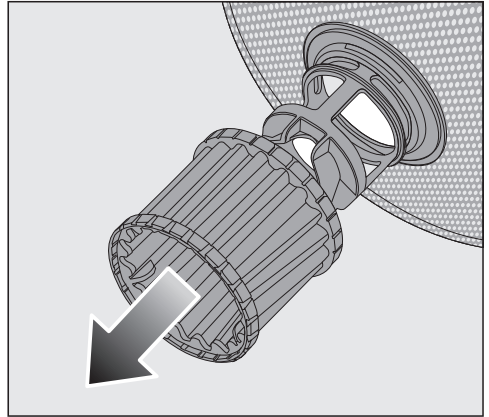





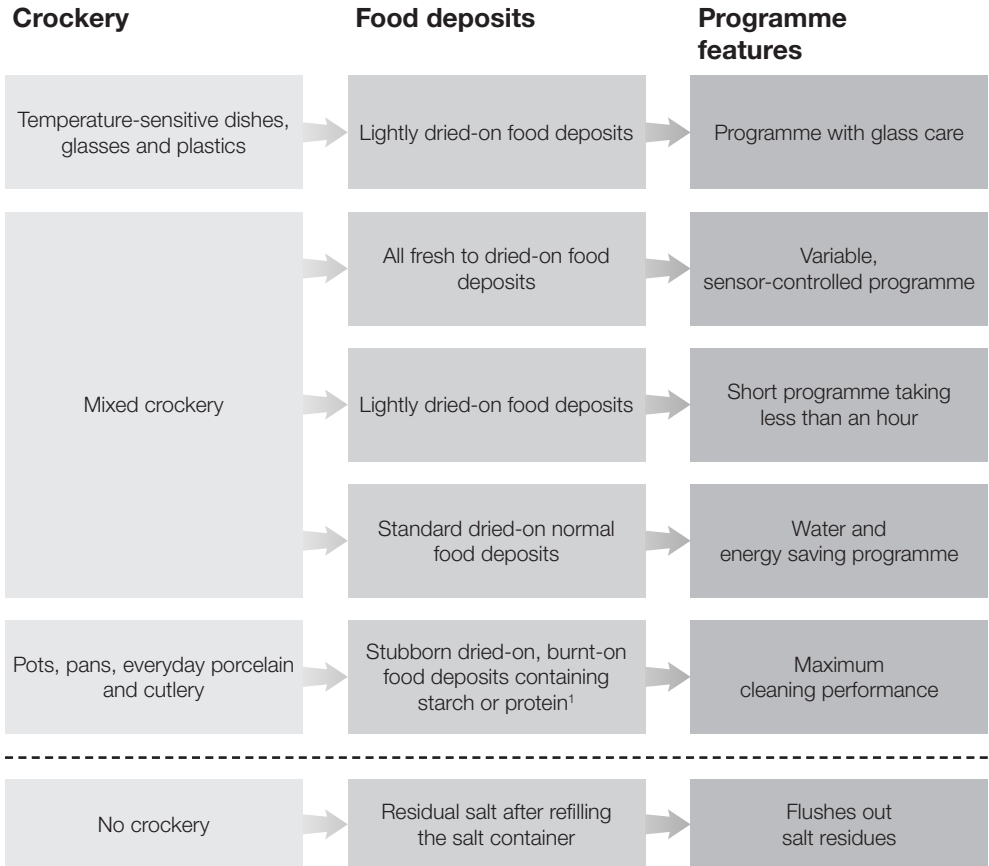







- In order to clean the inside of the filter, pull the microfilter downwards and away from the filter combination.
- Rinse all the parts under running water.
- Push the microfilter back onto the filter combination.
- Refit the filter combination so that it lies flat in the base of the wash cabinet.
- Refit the lower spray arm to the filter combination using the screw thread.
- Rotate the screw thread clockwise until the arrow in the viewing window points to the lock symbol .

Programme chart



¹ Food such as potatoes, pasta, rice or stews can leave starchy deposits. Deposits containing protein can be left by food such as fried meat or fish.

Programme ²	 ³	Consumption estimate ⁴						
 Gentle 45 °C 	20 ml	<table border="1"> <tr> <td>Energy consumption</td> <td></td> </tr> <tr> <td>Water consumption</td> <td></td> </tr> <tr> <td>Programme duration</td> <td></td> </tr> </table>	Energy consumption		Water consumption		Programme duration	
Energy consumption								
Water consumption								
Programme duration								
 Auto 45–65 °C 	30 ml	<table border="1"> <tr> <td>Energy consumption</td> <td></td> </tr> <tr> <td>Water consumption</td> <td></td> </tr> <tr> <td>Programme duration</td> <td></td> </tr> </table>	Energy consumption		Water consumption		Programme duration	
Energy consumption								
Water consumption								
Programme duration								
 QuickPowerWash 65 °C 	30 ml	<table border="1"> <tr> <td>Energy consumption</td> <td></td> </tr> <tr> <td>Water consumption</td> <td></td> </tr> <tr> <td>Programme duration</td> <td></td> </tr> </table>	Energy consumption		Water consumption		Programme duration	
Energy consumption								
Water consumption								
Programme duration								
 ECO	30 ml	<table border="1"> <tr> <td>Energy consumption</td> <td></td> </tr> <tr> <td>Water consumption</td> <td></td> </tr> <tr> <td>Programme duration</td> <td></td> </tr> </table>	Energy consumption		Water consumption		Programme duration	
Energy consumption								
Water consumption								
Programme duration								
 Intensive 75 °C 	30 ml	<table border="1"> <tr> <td>Energy consumption</td> <td></td> </tr> <tr> <td>Water consumption</td> <td></td> </tr> <tr> <td>Programme duration</td> <td></td> </tr> </table>	Energy consumption		Water consumption		Programme duration	
Energy consumption								
Water consumption								
Programme duration								
 QuickPowerWash 65 °C  + Express 	-	<table border="1"> <tr> <td style="text-align: center;"> Programme duration 13 minutes, no heating up, solely for flushing out salt. </td> </tr> </table>	Programme duration 13 minutes, no heating up, solely for flushing out salt.					
Programme duration 13 minutes, no heating up, solely for flushing out salt.								

² The programmes can be combined with the “Express”, “Extra clean”, “Extra dry” or “Second interim rinse” (if available) programme options (see “Programme options”).

³ Recommended amount of detergent (see “Detergent”).

⁴ The estimated values may change due to the selected settings or programme options, or the conditions in which the appliance is being used.