

Operating instructions Washing machine





To avoid the risk of accidents or damage to the appliance, it is **essential** to read these instructions before it is installed and used for the first time.

Contents

Warning and Safety instructions	5
Operating the washing machine	12
Control panel	12
How the sensors work.....	13
How the sensors work.....	13
Caring for the environment	14
Before using for the first time	15
Removing the open-end spanner.....	15
Washing environmentally and economically	17
1. Preparing the laundry	18
2. Loading the washing machine	19
3. Selecting a programme	20
4. Adding detergent	22
Detergent dispenser drawer	22
CapDosing.....	24
5. Starting the programme	26
Adding laundry during a programme sequence (AddLoad)	26
6. At the end of the programme	27
Spinning	28
Delay start	29
Programme chart	30
Extras	33
Short.....	33
Water +	33
Soak	33
Pre-wash	33
The following Extras can be selected in addition to the programme	34
Garment care label symbols	35
Programme sequence	36
Changing the programme sequence	38
Changing the programme (safety lock)	38
Cancelling a programme	38

Detergent	39
The correct detergent.....	39
Detergent dispensing aids.....	39
Fabric softeners and liquid starch	39
Miele detergents.....	41
Cleaning and care	43
External casing and fascia panel.....	43
Cleaning the detergent dispenser drawer	43
Hygiene info (Cleaning the drum)	45
Cleaning the water inlet filter.....	45
Problem solving guide	46
The programme does not start.....	46
The programme is cancelled and a fault indicator light lights up in the control panel.....	47
During the programme, a symbol appears in the time display	48
At the end of the programme, an indicator light lights up in the control panel ...	48
General problems with the washing machine	49
An unsatisfactory wash result	51
The door will not open.....	52
Opening the door in the event of a blocked drain outlet and/or power cut	53
Service	55
Contact in case of fault	55
Optional accessories.....	55
Warranty	55
Installation	56
Front view	56
Rear view.....	57
Installation surface	58
Transporting the washing machine to its installation site.....	58
Removing the transit bars	59
Fitting the transit bars	61
Levelling the machine.....	62
Screwing out and adjusting the feet.....	62
Installing under a continuous worktop	63
Washer and dryer stack	63
The Miele water protection system	64
Connection to the water supply	64
Drainage	66
Electrical connection	67

Contents

Technical data	68
Consumption data	69
Programmable functions	70
Opening the programming level.....	70
Choosing and selecting programmable functions.....	70
Editing and saving the programmable function.....	71
Exiting the programming level.....	71
<i>P13</i> Keypad tone.....	71
<i>P14</i> PIN Code.....	72
<i>P22</i> Indicator switch-off status.....	72
<i>P24</i> Memory.....	73
<i>P26</i> Longer pre-wash Cottons.....	73
<i>P27</i> Soak duration.....	73
<i>P28</i> Gentle action.....	73
<i>P29</i> Reduce temperature.....	74
<i>P30</i> Water plus.....	74
<i>P31</i> Water plus level.....	74
<i>P32</i> Maximum rinse level.....	74
<i>P33</i> Suds cooling.....	75
<i>P34</i> Anti-crease.....	75
<i>P49</i> Low water pressure.....	75
Detergents and care products	76
Detergent.....	76
Sensitive Skin (powder detergent).....	76
Specialist detergents 	77
Fabric care 	78
Additive 	78
Machine care products.....	78

Warning and Safety instructions

This washing machine complies with all current local and national safety requirements. However, inappropriate use can lead to personal injury and damage to property.

Read the operating instructions carefully before using the washing machine. They contain important information on safety, installation, use and maintenance of the appliance. This prevents both personal injury and damage to the washing machine.

In accordance with standard IEC 60335-1, Miele expressly and strongly advises that you read and follow the instructions in “Installation”, as well as in the “Warning and Safety instructions”.

Miele cannot be held liable for injury or damage caused by non-compliance with these instructions.

Keep these operating instructions in a safe place and pass them on to any future owner.

Correct application

- ▶ This washing machine is designed for domestic use and for use in similar environments by guests in hotel or motel rooms, bed & breakfasts and other typical living quarters. This does not include common/shared facilities or commercial facilities within hotels, motels or bed & breakfasts.
- ▶ The washing machine is not suitable for outdoor use.
- ▶ It must only be used to wash garments which have been declared suitable for washing by the manufacturer indicated on the garment care label. Any other use is not permitted. Miele cannot be held liable for damage resulting from incorrect or improper use or operation.

Warning and Safety instructions

▶ This washing machine is not intended for use by persons (including children) with reduced physical, sensory or mental capabilities, or lack of experience and knowledge, unless they have been given supervision or instruction concerning its use by a person responsible for their safety.

Safety with children

- ▶ Young children must not be allowed to use this appliance.
- ▶ Older children may only use the appliance when its operation has been clearly explained to them and they are able to use it safely, recognising the dangers of misuse.
- ▶ Cleaning work may only be carried out by older children under the supervision of an adult.
- ▶ Please supervise children in the vicinity of the washing machine and do not let them play with it.

Technical safety

- ▶ Please observe the instructions in “Installation” and “Technical data”.
- ▶ Before setting up the washing machine, check it for any externally visible damage. Do not install or use a damaged machine.
- ▶ Before connecting the washing machine, ensure that the connection data on the data plate (fuse rating, voltage and frequency) matches the mains electricity supply. If in any doubt, consult a qualified electrician.

Warning and Safety instructions

- ▶ Reliable and safe operation of this washing machine can only be assured if it has been connected to the mains electricity supply.
- ▶ The electrical safety of this washing machine can only be guaranteed when continuity is complete between it and an effective earthing system which complies with current local and national safety regulations. It is most important that this basic safety requirement is present and regularly tested and, where there is any doubt, the household wiring system should be inspected by a qualified electrician. Miele cannot be held liable for the consequences of an inadequate earthing system (e.g. electric shock).
- ▶ Do not connect the washing machine to the mains electricity supply by a multi-socket adapter, extension lead or similar. These do not guarantee the required safety of the machine (fire hazard due to the risk of overheating).
- ▶ Faulty components must only be replaced by genuine Miele spare parts. Miele can only guarantee the safety of the appliance when Miele replacement parts are used.
- ▶ The electrical socket must be easily accessible after installation so that the machine can be disconnected from the electricity supply if necessary.
- ▶ Unauthorised repairs could result in unforeseen dangers for the user, for which Miele cannot accept liability. Repairs should only be undertaken by a Miele authorised service technician, otherwise any subsequent damage will not be covered by the warranty.
- ▶ The manufacturer's warranty will be invalidated if the appliance is not repaired by a Miele approved service technician.

Warning and Safety instructions

- ▶ If the connection cable is faulty, it must only be replaced by a Miele approved service technician to protect the user from danger.
- ▶ In the event of a fault or for cleaning purposes, the washing machine is only completely isolated from the electricity supply when:
 - it is switched off at the wall socket and the plug is withdrawn, or
 - it is switched off at the mains circuit breaker.
- ▶ The machine must only be connected to the on-site water supply using a new hose kit. Old hose kits must not be re-used. Check the condition of the hoses regularly so that you can replace them in good time and avoid the risk of any water damage.
- ▶ The water flow pressure must be at least 100 kPa and must not exceed 1000 kPa.
- ▶ This washing machine must not be installed and operated in mobile installations (e.g. on a ship).
- ▶ Do not make any alterations to the machine, unless authorised to do so by Miele.
- ▶ In areas which may be subject to infestation by cockroaches or other vermin, pay particular attention to keeping the machine and its surroundings in a clean condition at all times. Any damage which may be caused by cockroaches or other vermin will not be covered by the machine warranty.

Correct use

- ▶ Do not install the washing machine in a room where there is a risk of frost. Frozen hoses may burst or split. The reliability of the electronic control unit may be impaired at temperatures below freezing point.
- ▶ Before using the machine for the first time, check that the transit bars at the rear of the machine have been removed (see “Installation - Removing the transit bars”). During spinning, a transit bar which is still in place may result in damage to both the machine and adjacent furniture or appliances.
- ▶ Turn off the tap if the machine is to be left for any length of time (e.g. holiday), especially if there is no floor drain (gully) in the immediate vicinity.
- ▶ Flooding danger.
If hooking the drain hose into a laundry washtub, check that the water can drain off quickly enough to prevent the laundry tub from overflowing. Make sure the drain hose is secure, so that the force of the water flowing out of the hose does not dislodge it.
- ▶ Take care to ensure that foreign objects (e.g. nails, pins, coins, paper clips) do not find their way into the machine with the laundry. These may damage components of the machine (e.g. suds container, drum), which in turn can result in damage to the laundry.

Warning and Safety instructions

- ▶ The maximum load for this washing machine is 7.0 kg (dry weight). See the “Programme chart” for the maximum recommended loads for individual programmes.
- ▶ If the correct amount of detergent is dispensed, the machine should not need to be descaled. If, however, you do wish to descale it, only use a proprietary natural citric acid based descaling agent. Miele recommends using Miele descaler for washing machines which is available to order online at shop.miele.com (depending on country) or from Miele. Strictly observe the instructions on the packaging.
- ▶ Textiles which have been pre-treated in solvent based cleaning agents must be thoroughly rinsed in clean water before being washed in the machine.
- ▶ Do not use solvent based cleaning agents, e.g. those containing benzene, in this machine, as this may result in damage to component parts and create toxic fumes. Such agents also pose a fire and explosion hazard.
- ▶ Do not use solvent based cleaning agents, e.g. those containing benzene, to clean the external surfaces of the machine. They can cause damage to plastic surfaces.
- ▶ Only use dyes specified by the manufacturer as being suitable for use in a domestic washing machine. Always observe the manufacturer's instructions carefully.

Warning and Safety instructions

- ▶ Colour run and dye removers contain sulphur compounds which can cause damage such as corrosion. Do not use these products in this machine.
- ▶ If detergent comes into contact with the eyes, rinse them thoroughly with lukewarm water immediately. If swallowed, seek medical assistance immediately and retain the packaging or label for reference. Those with skin problems or sensitive skin should avoid their skin coming into contact with detergent.

Accessories and spare parts

- ▶ Only use original Miele accessories and spare parts. If other parts are used, warranty, performance and product liability claims will be invalidated.
- ▶ A Miele tumble dryer can be stacked on top of a Miele washing machine using the appropriate stacking kit (available as an optional accessory). Please make sure you order the correct one for the Miele washing machine and Miele tumble dryer.
- ▶ Miele will guarantee to supply functional spare parts for a minimum of 10 years and up to 15 years following the discontinuation of your washing machine.

Miele cannot be held liable for damage caused by non-compliance with these Warning and Safety instructions.

Operating the washing machine



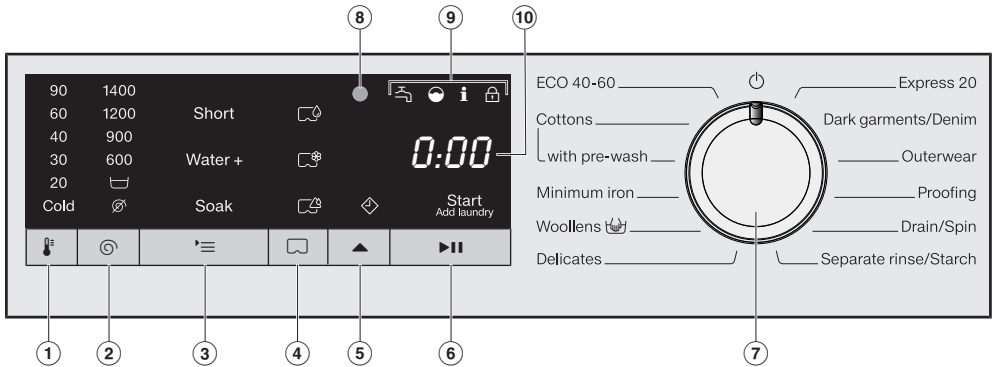

Control panel



- ① **🌡 sensor (temperature)**
for selecting the temperature
- ② **🌀 sensor (spin speed)**
for selecting the spin speed
- ③ **☰ sensor (Extras)**
for selecting Extras
- ④ **🗨 sensor (CapDosing)**
for activating detergent dispensing via a capsule
- ⑤ **▲ sensor (Delay start)**
for activating the Delay start function. With Delay start you can delay the start of a programme. The start of the programme can be delayed from 30 minutes up to a maximum of 24 hours. This allows you to make use of night-time economy electricity rates, for example.

- ⑥ **▶|| sensor (Start/Add laundry)**
 - Ⓐ The programme can be started as soon as *Start/Add laundry* is flashing on and off. Touching the ▶|| sensor starts the selected programme. *Start/Add laundry* lights up constantly.
 - Ⓑ Once the programme has been started, the ▶|| sensor allows you to add laundry.
- ⑦ **Programme selector**
For selecting programmes and for switching off the appliance. The washing machine is switched on by selecting a programme, and switched off by turning the programme selector to the ⏻ position.
- ⑧ **Optical interface**
For service technicians.

9 Indicator lights

-  lights up if there are faults with the water inlet and drainage
-  lights up if excess detergent was used
-  lights up as a reminder about hygiene information
-  The *Add laundry* function cannot be selected



10 Time display

After the programme has started, the programme duration will appear in the display in hours and minutes. When Delay start is being used, the programme duration will appear after the Delay start time has elapsed.

How the sensors work

The sensors control the values located above them.



The ①, ②, ③, ④, ⑤ and ⑥ sensors react to fingertip contact.

When a programme is selected, values are preset for the  and  sensors. Each touch of the sensor decreases the value. After the smallest value is reached, the display returns to the maximum value.

How the sensors work

The sensors control the values located above them.

The ①, ②, ③, ④, ⑤ and ⑥ sensors react to fingertip contact.

When a programme is selected, values are preset for the  and  sensors. Each touch of the sensor decreases the value. After the smallest value is reached, the display returns to the maximum value.

Caring for the environment

Disposal of the packing material

The transport and protective packaging has been selected from materials which are environmentally friendly for disposal, and can normally be recycled.

Recycling the packaging reduces the use of raw materials in the manufacturing process and also reduces the amount of waste in landfill sites. Ensure that any plastic wrappings, bags etc. are disposed of safely and kept out of the reach of babies and young children. Danger of suffocation.

Disposing of your old appliance

Electrical and electronic appliances often contain valuable materials. They also contain specific materials, compounds and components, which were essential for their correct function and safety. These could be hazardous to human health and to the environment if disposed of with your domestic waste or if handled incorrectly. Please do not, therefore, dispose of your old appliance with your household waste.



Please dispose of it at your local community waste collection / recycling centre for electrical and electronic appliances. You are also responsible for deleting any personal data that may be stored on the appliance prior to disposal. Please ensure that your old appliance poses no risk to children while being stored prior to disposal.

Before using for the first time

 Damage resulting from incorrect installation and connection.

Installing and connecting the washing machine incorrectly will cause serious damage to property. See "Installation".

Removing the open-end spanner

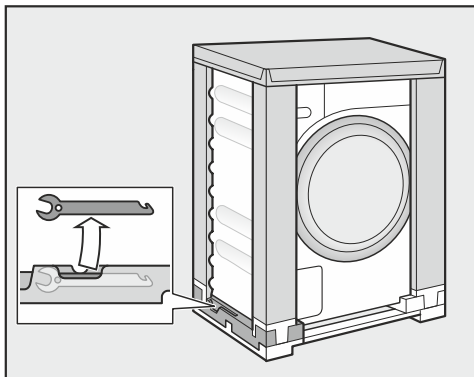

- Take out the open-end spanner for removing the transit bars from the bottom left of the transport packaging.

This washing machine has undergone a complete functional test at the factory and there will be some residual water in the drum from this process.

Remove the drain hose elbow from the drum

An elbow piece for the drain hose is stored in the drum.

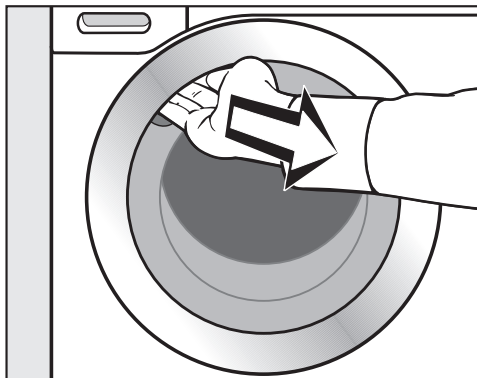

- Reach under the door grip and pull the door open.
- Remove the elbow piece.

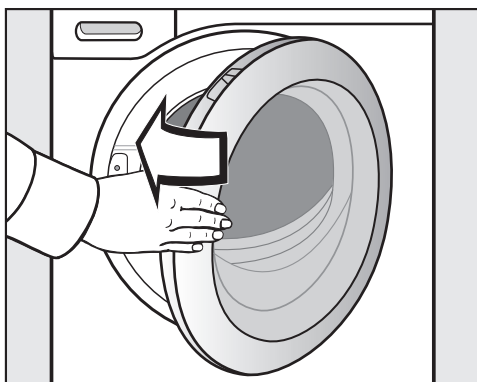

- Shut the door with a gentle swing.

Before using for the first time

Removing the protective foil and advertising stickers

■ Remove:

- the protective foil from the door (if present).
- any advertising stickers from the front and the lid.

Please do not remove any labels (e.g. the data plate) which are visible when you open the door.

Running the first programme

■ Turn on the tap.

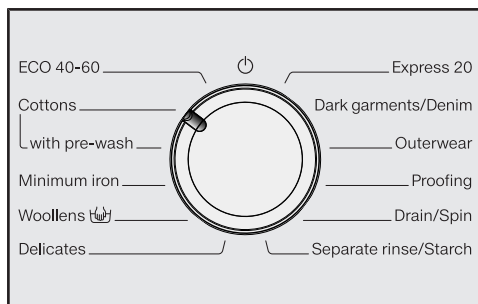

■ Turn the programme selector to the *Cottons* position.

The washing machine is now switched on and the temperature *40* and spin speed *1400* light up.

■ Touch the ►|| sensor.

The programme will start.

Opening the door at the end of the programme

The door remains locked during the Anti-crease phase. The indicators light up for the first 15 minutes.

■ Turn the programme selector to the  position.

-U- appears in the time display and the  indicator light goes out.

The door will unlock.

Useful tip: After the Anti-crease phase, the washing machine will have switched off and the door unlocked automatically.

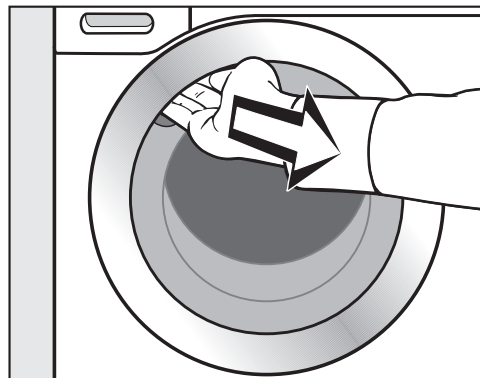

■ Reach under the door grip and pull the door open.



Useful tip: For safety reasons, close the door when the washing machine is not in use. Otherwise there is a danger of objects being placed inadvertently in the drum. If these remain unnoticed and were washed in the next load, they could damage the laundry. An open door is also a danger to pets and children.

The appliance is now ready for use.

Washing environmentally and economically

Energy and water consumption

- To get the most out of your machine, load the maximum dry load size for the wash programme you are using. This will keep the energy and water consumption to a minimum in relation to the size of the load.
- Programmes that are more efficient with regard to energy and water consumption generally have a longer running time. By extending the programme running time, the wash temperature that is actually reached can be reduced while still providing the same wash results.

For example, the Cottons  programme has a longer running time than the Cottons 40°C or 60°C programme, but the Cottons  programme is more efficient in terms of energy and water consumption.

- Use the Express 20 programme for small, lightly soiled loads.
- Modern detergents make it possible to wash at lower temperatures (e.g. 20°C). Using lower temperature settings will save energy.

Hygiene in the washing machine

Washing at low temperatures and/or using liquid detergents can cause bacteria and odours to build up in the washing machine. Miele therefore recommends cleaning the washing machine once every month.

When the  indicator light appears in the control panel, the washing machine must be cleaned.

Information about subsequent tumble drying

The spin speed selected affects the residual moisture in the laundry and the sound emissions of the washing machine.

The higher the spin speed, the lower the residual moisture in the laundry. However, the sound emissions of the washing machine will increase.

Select the highest possible spin speed for the wash programme to save energy in the subsequent tumble dryer cycle.

Detergent consumption

- Do not exceed the amounts of detergent recommended by the manufacturer on the packaging.
- Adjust the dosage to the degree of soiling of the laundry.
- Reduce the amount of detergent with smaller loads (approx. $\frac{1}{3}$ less than the amount recommended can be used when washing a half load).

1. Preparing the laundry

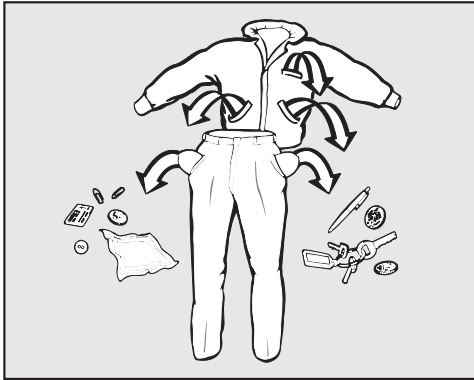

- Empty all pockets.

⚠ Damage due to foreign objects. Nails, coins, paper clips, and so on can cause damage to garments and components in the machine. Check the laundry before washing and remove any foreign objects.

Sorting the laundry

- Sort the laundry by colour and by care label. Most garments have a textile care label in the collar or side seam.

Useful tip: Dark textiles often contain excess dye and should be washed separately several times before being included in a mixed load. Always wash white and coloured items separately.

Pre-treating stains

- Badly soiled areas and stains should be cleaned as soon as possible, preferably whilst still fresh. Spillages should be carefully dabbed off using a soft, colourfast cloth. Do not rub.

Useful tip: Please refer to the Miele website or Miele@mobile App for more information on stain removal.

⚠ Damage due to solvent-based cleaning agents. Cleaning agents containing benzene, stain remover, etc., can damage plastic parts. When pre-treating garments, make sure that any plastic parts (e.g. buttons) do not come into contact with cleaning agent.

⚠ Risk of explosion due to solvent-based cleaning agents. If solvent-based cleaning agents are used, an explosive mixture can form. Never use solvent-based cleaning agents in the washing machine.

General tips

- Curtains: Remove lead weights first or place in a laundry bag.
- Underwiring and collar stiffeners: Any loose wiring in bras, shirt collar stiffeners, etc. should be removed or sewn in.
- Close any zips, attach Velcro fasteners, fasten hooks and eyes etc. before washing.
- Fasten duvet covers and pillow cases to prevent small items from being rolled up inside them.

Do not wash any items in this machine which are specified by the manufacturer as **not washable** on the care label (☒ symbol).

2. Loading the washing machine

Opening the door



- Reach under the door grip and pull the door open.

Check the drum for pets or foreign objects before loading it with laundry.

The most efficient use of energy and water is achieved when a full load is washed. However, do not overload as this reduces cleaning efficiency and causes creases.

- Unfold the laundry and load loosely in the drum.

Mixing both large and small items gives better wash results and also helps distribute the load evenly during spinning.

Useful tip: Please note the maximum load for the different wash programmes.

Closing the door

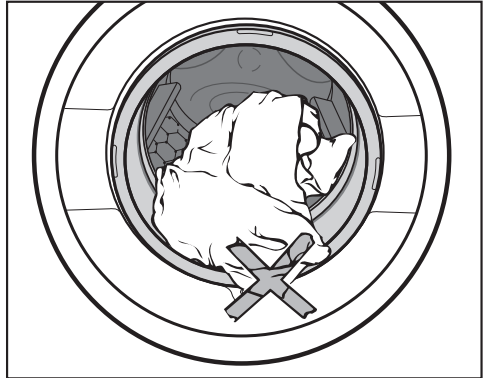

- Make sure that no items are caught between the door and the seal.

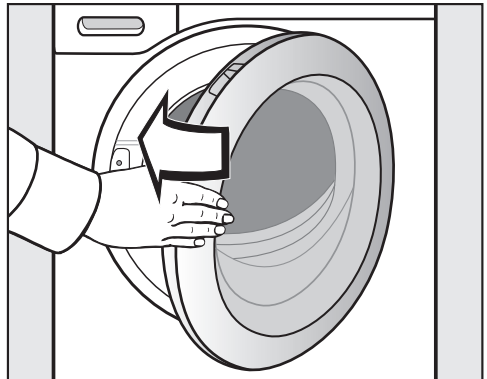

- Shut the door with a gentle swing.

3. Selecting a programme

Programme selection

The washing machine is switched on by turning the programme selector to a wash programme.

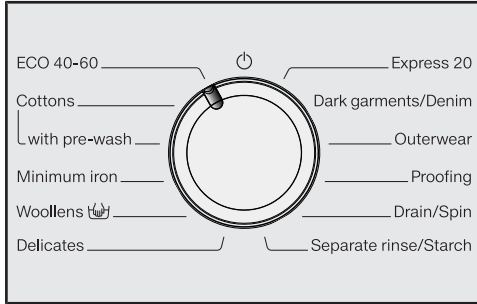

- Turn the programme selector to the required programme.

The estimated wash time is shown in the time display and the preset temperature and spin speed light up.

Selecting the temperature and spin speed

The wash programme's preset temperature and spin speed light up brightly.

The temperatures reached in the washing machine may differ from the selected temperatures. The combination of energy input and washing time achieves an optimum washing result.

90	1400	
60	1200	
40	900	
30	600	
20		
Cold		

- Touch the sensor to change the preset temperature. Each touch of the sensor decreases the value. After the smallest value is reached, the display jumps to the maximum value.
- Touch the sensor to change the preset spin speed. Each touch of the sensor decreases the value. After the smallest value is reached, the display jumps to the maximum value.

3. Selecting a programme

Selecting Extras

In some programmes, you can combine 2 Extras.

In other programmes, you can only select 1 Extra or there are no available Extras.



■ Touch the '≡' sensor:

- **Once:** the *Short* Extra is selected and lights up.
- **2 times:** the *Water +* Extra is selected and lights up.
- **3 times:** the *Soak* Extra is selected and lights up.
- **4 times:** the *Short* and *Water +* Extras are selected and light up.
- **5 times:** the *Water +* and *Soak* Extras are selected and light up.
- **6 times:** all the Extras are deselected.

Please refer to “Extras” for more information.

4. Adding detergent

Detergent dispenser drawer

Any detergent suitable for automatic front loading washing machines can be used with this appliance. Please observe the instructions for use and dosage on the detergent packaging.

Filling with detergent

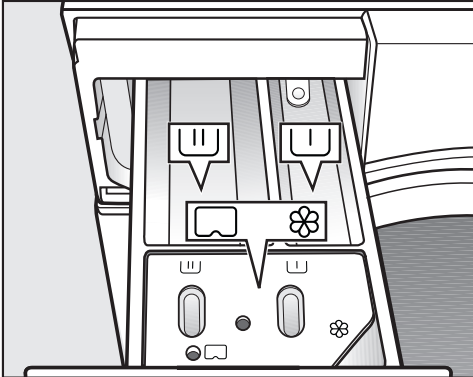

- Pull out the detergent drawer and add detergents to the compartments.

U U Detergent for the pre-wash (divide the total recommended amount as follows: add $\frac{1}{3}$ to compartment U U and $\frac{2}{3}$ to compartment U U)

U U Detergent for the main wash and soaking

⊗ Fabric softener, liquid starch, or U capsules

See “Detergent” for further information.

Adding fabric softener

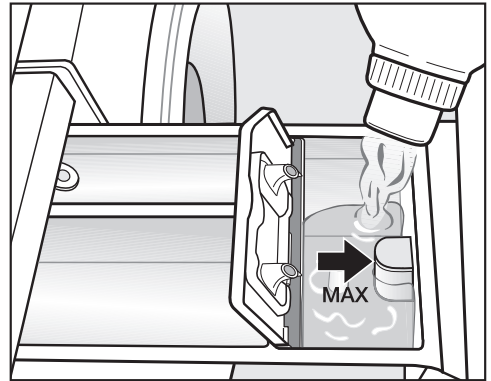

- Add fabric softener or liquid starch to the ⊗ compartment. **Do not exceed the maximum level mark.**

It will be automatically dispensed in the final rinse. At the end of the programme a small amount of water remains in the fabric softener ⊗ compartment.

Starch can make the siphon tube sticky.

If starching frequently, thoroughly clean the dispenser compartment, especially the siphon tube, regularly.

4. Adding detergent

Tips on dosing

Adjust the detergent dosage to the level of soiling of the laundry and the size of the load. Reduce the amount of detergent with smaller loads (e.g. reduce the amount of detergent by $\frac{1}{3}$ when washing a half load).

Too little detergent results in:

- laundry not getting properly clean and with time it may become grey and hard to the touch.
- a build-up of mould in the washing machine.
- grease not being completely removed from the laundry.
- limescale deposits on the heater elements.

Too much detergent results in:

- poor wash, rinse, and spin results.
- a higher water consumption as an extra rinse cycle is automatically activated.
- a greater burden on the environment.

Using liquid detergent with a pre-wash

Liquid detergent cannot be used for the main wash if the pre-wash has been selected.

Use powder detergent for the main wash.

Using detergent tablets or pods

Always put detergent tablets or pods directly in the drum with the laundry. They cannot be added via the detergent dispenser drawer.

See “Detergent” for further information on detergents and dosage.

4. Adding detergent

CapDosing

Three different types of capsule are available:

- ☼ = Fabric care (e.g. fabric softener)
- ☼☼ = Additives (e.g. booster)
- ☼☼☼ = Detergent (for the main wash only)

Each capsule contains the correct amount for one wash cycle.

You can order the capsules online at shop.miele.com (depending on country) or from Miele (see the end of this booklet for contact details).

⚠ Capsules pose a health risk. The ingredients of capsules can be hazardous to health if they are swallowed or come into contact with skin. Keep capsules out of the reach of children.

Activating CapDosing

- Touch the ☼ sensor:
 - **Once:** the ☼☼ symbol is selected and lights up.
 - **2 times:** the ☼☼☼ symbol is selected and lights up.
 - **3 times:** the ☼☼☼☼ symbol is selected and lights up.
 - **4 times:** CapDosing is switched off.

Inserting a capsule

- Open the detergent dispenser drawer.

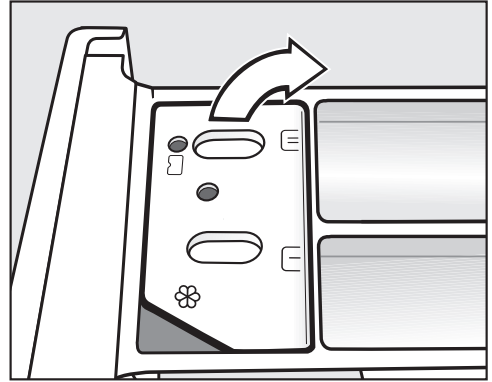

- Open the lid of the ☼☼☼☼ compartment.

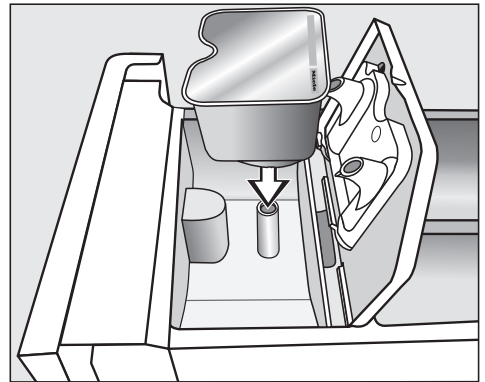

- Press the capsule in firmly.

4. Adding detergent

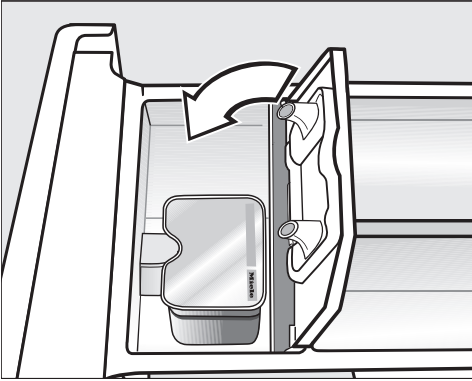

The wash programme will dispense the contents of the capsule at the correct time.

Water intake to the ☼ compartment is solely via the capsule.

No additional fabric softener may be added to the ☼ compartment when using a capsule.

- Close the lid and press it firmly shut.
- Close the detergent dispenser drawer.

- Remove the empty capsule at the end of the programme.

For technical reasons a small amount of water will remain in the capsule.

The capsule is opened by the act of inserting it in the detergent dispenser drawer. The contents can run out of the capsule if you then remove it from the drawer before it is used. In this case, dispose of the capsule and do not re-use it.

5. Starting the programme

Starting a programme



- Touch the ▶|| sensor.

The door will lock and the programme will start.

If a Delay start time has been selected, this counts down in the time display. At the end of the Delay start time or immediately after the programme has started, the programme duration will appear in the time display.

Switching the indicators on and off

The indicators dim automatically after 15 minutes.

You can reactivate the indicators:

- Turn the programme selector.



The indicators are switched on again. If you do not reset the programme selector to the previously selected programme, the -D- symbol will light up in the time display.

To prevent the programme from being cancelled, do **not** turn the programme selector to the ⏻ position.

Adding laundry during a programme sequence (AddLoad)

Laundry can be added or removed at any time, provided that the  symbol is not illuminated in the display.

- Touch the ▶|| sensor.

Rotating bars  ...  ...  are shown in the time display.

If the word *Add* appears in the time display, the door can be opened.

- Open the door. Add or remove laundry.
- Close the door.
- Touch the ▶|| sensor.

The wash programme will continue.

Laundry cannot be added or removed if:

- The suds temperature is above 55°C
- The water inside the drum is above a certain level

6. At the end of the programme

Opening the door and removing the laundry

The door remains locked during the Anti-crease phase. The indicators light up for the first 15 minutes.

0:00 appears in the time display.

- Turn the programme selector to the  position.

The  indicator light will go out.

The door will unlock.

Useful tip: After the Anti-crease phase, the door will unlock automatically.

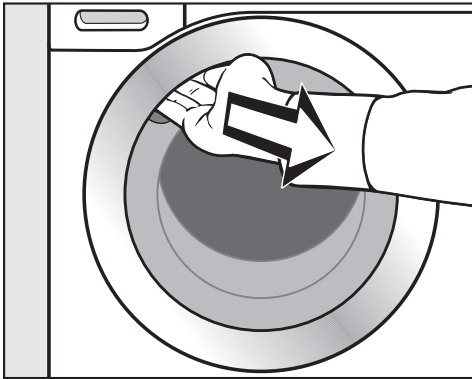

- Reach under the door grip and pull the door open.
- Remove the laundry.

Items left in the drum could discolour other items in the next wash or become discoloured themselves. Check that all items have been removed from the drum.

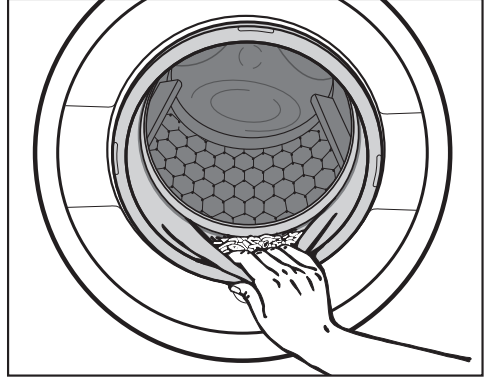

- Check the folds in the door seal for any small articles, e.g. buttons, which might be lodged there.

Useful tip: For safety reasons, close the door when the washing machine is not in use. Otherwise there is a danger of objects being placed inadvertently in the drum. If these remain unnoticed and were washed in the next load, they could damage the laundry. An open door is also a danger to pets and children.

- If applicable, remove the used capsule from the detergent dispenser drawer.

Useful tip: Leave the detergent dispenser drawer slightly open to allow it to dry.

Spinning

Final spin speed in wash programmes

When a programme is selected, the sensor for the optimum spin speed for that programme will be brightly lit up in the control panel.

A faster spin speed can be selected for certain wash programmes.



The highest selectable spin speed is indicated in the table.

Programme	rpm
ECO 40-60	1400
Cottons	1400
Minimum iron	1200
Woolens 	1200
Delicates	900
Express 20	1200
Dark garments/Denim	1200
Outerwear	900
Proofing	1200
Drain/Spin	1400
Separate rinse/Starch	1200

Rinse and interim spin

There is a spin after the main wash and between the rinses. A reduction in the final spin speed will also reduce the interim spin speed. If a spin speed of less than 700 rpm is selected for the *Cottons* programme, an additional rinse is introduced.

Deselecting final spin (Rinse hold)

- Touch the  sensor repeatedly until the  indicator (Rinse hold) lights up.



The laundry is not spun after the final rinse and remains in the rinse water. This helps prevent creasing if the laundry is not going to be removed from the drum immediately after the end of the programme.

Ending a programme with a spin cycle

The indicator with the ideal spin speed lights up. You can change the spin speed with the  sensor.



- Touch the  sensor.

Ending a programme without a spin cycle

- Touch the  sensor repeatedly until the  indicator (without spin) lights up.

- Touch the  sensor.

Deselecting the interim spin and the final spin

- Touch the  sensor repeatedly until the  indicator (without spin) lights up.

After the last rinse, the water will be pumped away and the Anti-crease phase will switch on.

In some programmes an additional rinse is introduced with this setting.

With Delay start you can delay the start of a programme from 30 minutes up to a maximum of 24 hours. This allows you to make use of night-time economy electricity rates, for example.

Selecting Delay start

Delay start is not possible in the *Drain/Spin* and *Proofing* programmes.

- Select the programme required.

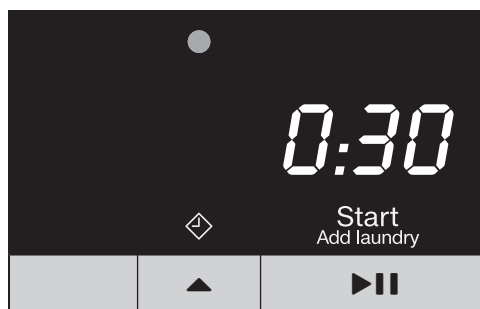

- Touch the ▲ sensor.

The ◊ symbol lights up brightly and the first 30 minutes of the Delay start time appear in the time display.

- Touch the ▲ sensor repeatedly until the required Delay start time lights up in the time display.

- For below 3 hours, the Delay start time changes in increments of 30 minutes.
- For more than 3 hours, the Delay start time changes in increments of 1 hour.

Useful tip: If you touch and hold the ▲ sensor, the time automatically counts up to 24 hours.

Starting Delay start

- Touch the ►|| sensor.

The Delay start process starts and counts down in the time display.

Changing or cancelling a started Delay start time

If the selected Delay start function has started, it is no longer possible to change the time.

- Turn the programme selector to the ⏻ position.
- Turn the programme selector to any programme.

Rotating bars [] ... [] ... [] are shown in the time display.

The door lock is released.

- Select a programme and a new Delay start time if required.

Programme chart

ECO 40-60		Max. load 7.0 kg
Items	For normally soiled cotton garments	
Notes	A laundry load consisting of mixed cottons that are intended for washing at 40°C or 60°C can be washed in the same wash cycle.	
<p>Information for customers:</p> <p>You cannot normally select any temperatures or Extras for the <i>ECO 40-60</i> wash programme.</p>		
<p>Note for test institutes:</p> <p>For energy labelling programme according to AS/NZS 2040.1 & AS/NZS 2040.2 change the following settings:</p> <p>Temperatures 60 and 40 light up in the temperature display.</p> <ul style="list-style-type: none"> - Touch the temperature sensor  2 times for the test programme. Only 40 lights up in the display. (refer to www.energyrating.gov.au website for consumption data). <p>The detergent must be added via the detergent dispenser drawer.</p>		
Cottons		Cold to 90°C
Max. load 7.0 kg		
Items	Cottons, linens or cotton mix fabrics, e.g. table linen, towelling, underwear, T-shirts etc.	
Notes	<p>Where particularly high levels of hygiene are required, please select a temperature of 60°C or higher.</p> <p>If you want to select a pre-wash programme, turn the programme selector to <i>Pre-wash</i>.</p>	

Programme chart

Minimum iron		Cold to 60°C	Max. load 3.5 kg
Items	Synthetic, mixed fibre and easy care cotton.		
Notes	Reduce the spin speed for fabric that creases easily.		
Woollens 		Cold to 40°C	Max. load 2.0 kg
Items	Machine-washable or hand-washable wool or wool blend fabric. If the care label does not specify a temperature, wash using the cold setting.		
Notes	Reduce the spin speed for fabrics that crease easily.		
Delicates		Cold to 40°C	Max. load 2.0 kg
Items	Delicate garments made from synthetic fibre, mixed fibre, rayon and viscose. Curtains specified as machine-washable by the manufacturer.		
Notes	<ul style="list-style-type: none"> - Dust in curtains usually means that a programme with pre-wash is advisable. - For items which crease easily, deselect the spin. 		
Express 20		Cold to 40°C	Max. load 3.5 kg
Items	Cotton garments that have hardly been worn or are only very lightly soiled.		
Notes	The <i>Short Extra</i> is activated automatically.		
Dark garments/ Denim		Cold to 60°C	Max. load 3.0 kg
Items	Black and dark garments made from cotton, mixed fibres and denim.		
Notes	<ul style="list-style-type: none"> - Wash inside out. - Denim often contains excess dye and may run during the first few washes. Wash light and coloured items separately. 		

Programme chart

Outerwear		Cold to 40°C	Max. load 2.5 kg
Items	Performance outerwear (e.g. jackets and trousers) made from membrane fabric such as Gore-Tex®, SYMPATEX®, WINDSTOPPER®, etc.		
Notes	<ul style="list-style-type: none"> - Close any zips and Velcro fasteners before washing. - Do not use fabric softener. - If required, these items can also be reproofed using the <i>Proofing</i> programme. Reproofing after each wash cycle is not recommended. 		
Proofing		40°C	Max. load 2.5 kg
Items	Treating microfibre fabric, ski wear or table linen made from mainly synthetic fibres to provide a finish that is resistant to water and dirt.		
Notes	<ul style="list-style-type: none"> - The items should be freshly laundered and spun or dried before proofing. - For best results, the items should be heat-treated afterwards. This can be achieved by drying them in the tumble dryer or by ironing them. 		
Drain/Spin			-
Notes	<ul style="list-style-type: none"> - Drain only: Set spin speed to . - Make sure you select the appropriate spin speed. 		
Separate rinse/Starch			Max. load 7.0 kg
Items	<ul style="list-style-type: none"> - For rinsing hand-washed items. - For starching table cloths, serviettes and workwear. 		
Notes	<ul style="list-style-type: none"> - Reduce the spin speed for fabrics that crease easily. - Laundry that is to be starched should be washed but not treated with fabric softener. - Items will be rinsed very effectively with 2 rinses by activating the <i>Water + Extra</i>. 		

You can use the Extras sensor to augment the wash programmes.

Use the ►☰ sensor to select or deselect Extras.

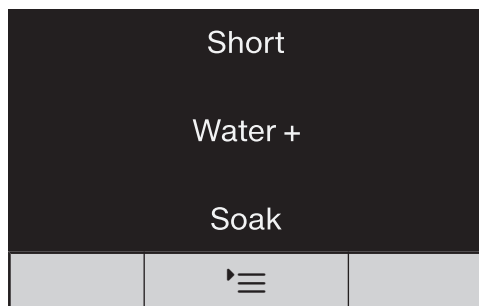

■ Touch the ►☰ sensor:

- **Once:** the *Short* Extra is selected and lights up.
- **2 times:** the *Water +* Extra is selected and lights up.
- **3 times:** the *Soak* Extra is selected and lights up.
- **4 times:** the *Short* and *Water +* Extras are selected and light up.
- **5 times:** the *Water +* and *Soak* Extras are selected and light up.
- **6 times:** all the Extras are deselected.

Short

For light soiling with no visible staining.

The wash duration is reduced.

Water +

The water level in the main wash and the rinse cycles is increased. A second rinse cycle is carried out in the *Separate rinse/Starch* programme.

You can select other functions for the *Water +* sensor. These are described under "Programmable functions".

Soak

For cleaning heavily soiled and stained items with protein stains.

- A duration of between 30 minutes and 2 hours can be programmed in 30-minute increments for the soak process.
- The factory default setting is 30 minutes.

See "Programmable functions – Soak" for instructions on how to programme a different soak period.

Pre-wash

For laundry with large amounts of dirt, e.g. dust and sand.

Extras

The following Extras can be selected in addition to the programme





	Short	Water +	Soak	Pre-wash
ECO 40-60	-	-	-	-
Cottons	●	●	●	●
Minimum iron	●	●	●	-
Woollens 	-	-	-	-
Delicates	●	●	●	-
Express 20	✓	-	-	-
Dark garments/Denim	●	●	●	-
Outerwear	●	●	●	-
Proofing	-	-	-	-
Separate rinse/Starch	-	●	-	-

● = can be selected







✓ = activated automatically



- = cannot be selected





Garment care label symbols





Washing	
The figure quoted in the symbol is the maximum temperature at which the garment can be washed. The number of bars under the symbol indicates the level of agitation permitted.	
	No bar under the symbol = normal agitation
	One bar under the symbol = reduced agitation
	Two bars under the symbol = much reduced agitation
	Hand wash (If no temperature is specified, use the lowest temperature or cold)
	Do not wash



Programme selection examples

Programme	Garment care label symbols
ECO 40-60	
Cottons	
Minimum iron	
Delicates	
Woolens 	
Express 20	





















Drying	
The number of dots indicates the drying temperature.	
	Normal temperature
	Low temperature
	Do not tumble dry

Ironing	
The number of dots indicates the ironing temperature.	
	approx. 200°C
	approx. 150°C
	approx. 110°C
	Do not steam iron garments carrying this symbol as this could cause irreversible damage.
	Do not iron



Professional cleaning	
	Dry clean only. The letters indicate the type of cleaning agent required.
	
	Professional Wet Clean only
	Do not dry clean

Bleaching	
	Any oxidising bleaching agent can be used
	Only use an oxygen based bleach or a non-chlorine bleach
	Do not bleach

Programme sequence

	Main wash		Rinse		Spin
	Water level	Wash rhythm	Water level	Rinses	
ECO 40-60		(A)		2-3 ²	✓
Cottons		(A)		2-5 ^{1,2,3}	✓
Minimum iron		(B)		2-4 ^{2,3}	✓
Woolens 		(E)		2	✓
Delicates		(C)		2-4 ^{2,3}	✓
Express 20		(A)		1	✓
Dark garments/Denim		(B)		3-5 ^{2,3}	✓
Outerwear		(C)		3-4 ³	✓
Proofing	-	(B)		1	✓
Drain/Spin	-	-	-	-	✓
Separate rinse/Starch		(B)		0-1 ⁵	✓

Please see the next page for a description of the symbols.

-  = low water level
 = medium water level
 = high water level
Ⓐ = intensive rhythm
Ⓑ = normal rhythm
Ⓒ = sensitive rhythm
Ⓔ = handwash rhythm
✓ = carried out
– = not carried out

This washing machine has fully electronic controls with automatic load control. The washing machine takes in the right amount of water required for the programme depending on the amount of laundry and its absorbency rate.

The programme sequences outlined in the chart are based on the basic programme with a full load.

Special features in the programme sequence

Anti-crease:

At the end of the programme the drum continues to turn at intervals for up to 30 minutes to help prevent creasing.

Exception: There is no Anti-crease phase in the *Woolens*  programme. The door can be opened at any time during the Anti-crease phase.

- ¹ If a temperature of 60°C or higher is selected, two rinses are carried out. If a temperature of less than 60°C is selected, three rinses are carried out.
- ² An additional rinse is carried out if:
 - there is too much foam in the drum.
 - a spin speed lower than 700 rpm has been selected.
- ³ An additional rinse is carried out if:
 - the *Water + Extra* has been selected and the options *U2* or *U3* have been activated in Programmable functions.
- ⁵ An additional rinse is carried out if:
 - the *Water + Extra* has been selected.

Changing the programme sequence

Changing the programme (safety lock)



It is not possible to change the programme, the temperature, the spin speed or the selected Extras after the programme has started. This prevents the appliance being operated unintentionally, e.g. by children.

If the washing machine is switched off during active programme operation, the standby function does not switch the washing machine off completely after 15 minutes. Safety functions continue to be active because there may still be water inside the drum.

Cancelling a programme

You can cancel a programme at any time after it has started.

- Turn the programme selector to the  position.
- Turn the programme selector to any position.

Rotating bars  ...  ...  are shown in the time display.

The water is pumped away and the door lock is released.

Selecting a new programme

- Turn the programme selector to the required programme.
- Check that there is still sufficient detergent in the detergent drawer. Add more detergent if necessary.
- Touch the  sensor.

The correct detergent

All detergents produced for automatic front loading washing machines are suitable. Follow the manufacturer's instructions and dosage recommendations on the packaging.

The right amount to dispense will depend on the following:

- The soiling level of the laundry.
- The quantity of laundry.
- The water hardness level. Check with your local water authority if you do not know the water hardness level in your area.

Detergent dispensing aids

Use dispensing aids (e.g. balls) if these are supplied with the detergent, particularly when using liquid detergent.

Refill packs of detergent

When purchasing detergent, buy refill packs wherever possible. This helps reduce the amount of waste packaging.

Fabric softeners and liquid starch

Fabric softeners

make garments soft to handle and help prevent static cling when tumble drying.

Fabric shapers

are synthetic starches and give an even stiffer hold.

Starch







stiffens and gives body to items of laundry, e.g. shirts, tablecloths and bed linen.

Detergent

Using fabric softener or starch separately

Prepare the starch in accordance with the manufacturer's instructions on the packaging.

Useful tip: When adding fabric softener, activate the *Water + Extra*.

- Add fabric softener to the  compartment or insert the appropriate capsule.
- Add liquid starch to the  compartment and powder or viscous starch to the  compartment.
- Select the *Separate rinse/Starch* programme.
- Change the spin speed if necessary.
- Use the  sensor to activate the  symbol if using a capsule.
- Touch the  sensor.

Colour run and dye removers/dyes

 Damage due to colour run/dye removers.





Colour run and dye removers can cause corrosion in the washing machine.

Do not use colour run or dye removers in this washing machine.

Dyes suitable for use in domestic washing machines can be used. However, please note that the salt used in the dyeing process can cause corrosion to stainless steel components in the machine if you use dye frequently. Always observe the manufacturer's instructions carefully.

Miele detergents

Miele detergents have been specially designed for everyday use in Miele washing machines. See “Detergents and care products” for more information about these detergents.

	Miele detergents		Miele capsules		
	UltraWhite	UltraColor			
ECO 40-60	✓	✓	-	✓	✓
Cottons	✓	✓	-	✓	✓
Minimum iron	-	✓	-	✓	✓
Woolens 	-	-	✓	-	-
Delicates	-	✓	✓	✓	-
Express 20	-	✓	-	✓	-
Dark garments/Denim	-	✓	✓	✓	-
Outerwear	-	-	✓	-	-
Separate rinse/Starch	-/-	-/-	-/-	✓/-	-/-

✓ recommended

- not recommended



Specialist detergents (e.g. WoolCare)



Fabric care (e.g. fabric softener)



Additive (e.g. booster)

Detergent

The recommendations apply to the temperature ranges given in the Programme chart.

	Universal	Colour	Delicates and woollens	Special
	detergent			
ECO 40-60	✓	✓	-	-
Cottons	✓	✓	-	-
Minimum iron	-	✓	-	-
Woollens 	-	-	✓	✓
Delicates	-	-	✓	-
Express 20	-	✓ ¹	-	-
Dark garments/Denim	-	✓ ¹	-	✓
Outerwear	-	-	✓	✓

- ✓ recommended 1 Liquid detergent
- not recommended 2 Powder detergent

External casing and fascia panel

⚠ Risk of electric shock!
Mains voltage is present when the washing machine is switched off. Disconnect the machine from the electricity supply before cleaning or maintenance.

⚠ Risk of damage due to ingress of water.
The pressure of a water jet can cause water to get into the washing machine, resulting in damage to components.
Do not spray the washing machine with a water jet or high pressure hose.

- Clean the casing and control panel with a mild cleaning agent or soap and water and dry both with a soft cloth.
- The drum can be cleaned using a suitable stainless steel cleaning agent following the manufacturer's instructions on the packaging.

⚠ Damage caused by cleaning agents.
Solvent based cleaning agents, abrasive cleaners, glass cleaners or multi-purpose cleaning agents can cause damage to plastic surfaces and other parts.
Do not use any of these cleaning agents.

Cleaning the detergent dispenser drawer

Washing at low temperatures and the use of liquid detergent can lead to a build-up of mould and bacteria in the detergent dispenser drawer.

- For hygiene reasons, clean the entire drawer at regular intervals.

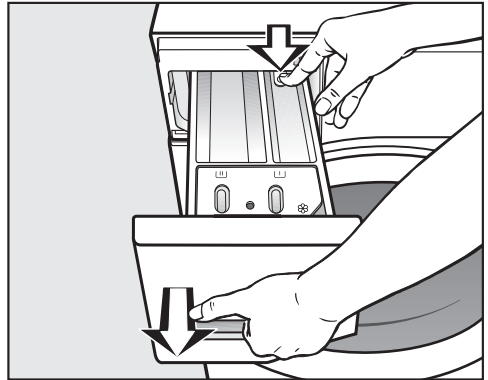

Removing the detergent dispenser drawer





- Pull out the detergent dispenser drawer until a resistance is felt. Press down the release button and at the same time pull the drawer right out of the machine.
- Clean the detergent drawer with warm water.

Cleaning and care

Cleaning the siphon and the compartment channel

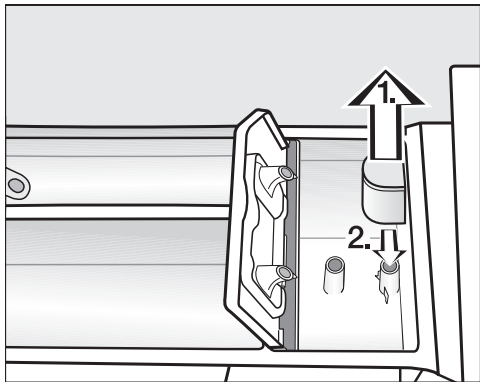
Liquid starch results in clogging. If clogged, the siphon in the   compartment will not work and the compartment can overflow. Clean the siphon particularly thoroughly after using liquid starch a few times.



1. Remove the siphon from the  compartment and clean under warm running water. Clean the siphon tube in the same way.
2. Refit the siphon.

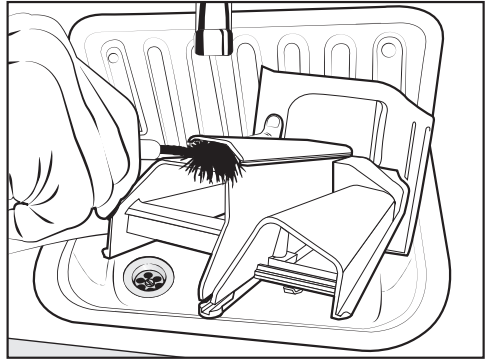

- Clean the fabric softener channel using a brush and warm water.

Cleaning the detergent dispenser drawer housing

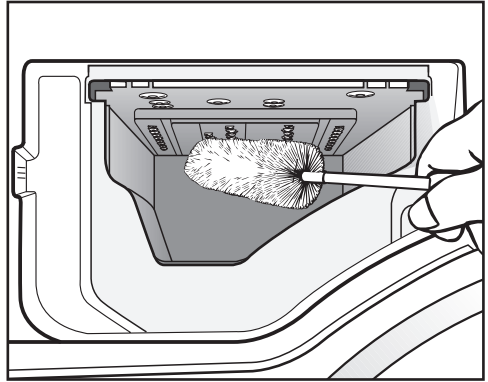

- Use a bottle brush to remove detergent residues and limescale from the jets inside the detergent dispenser drawer compartment.
- Replace the detergent dispenser drawer.

Useful tip: Leave the detergent dispenser drawer slightly open to allow it to dry.

Hygiene info (Cleaning the drum)

Washing at low temperatures and/or using liquid detergent can cause bacteria and unpleasant odours to build up in the washing machine. Use the *Cottons* 90 °C programme to clean the washing machine. Clean the drum at the latest when the **i** indicator light lights up and **!** appears in the time display.

Cleaning the water inlet filter

The washing machine has 2 filters to protect the inlet valve. Check these filters every 6 months or so. Perform this check more often if there are frequent interruptions to the external water supply.

Cleaning the filter in the inlet hose

- First turn off the tap.
- Unscrew the inlet hose.

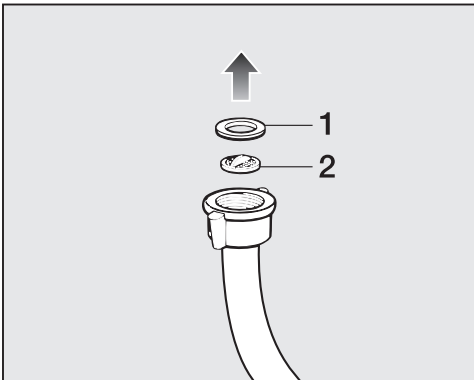

- Remove the rubber seal **1** from the recess.
- Using pointed pliers, take hold of the plastic filter bar **2** and remove the plastic filter.

- Clean the filter and the seal.
- Reassemble the filter and seal in the reverse order and reconnect the hose.

Cleaning the filter in the inlet valve

- Using pliers, carefully loosen the ribbed plastic nut (seal) on the inlet valve and unscrew it.

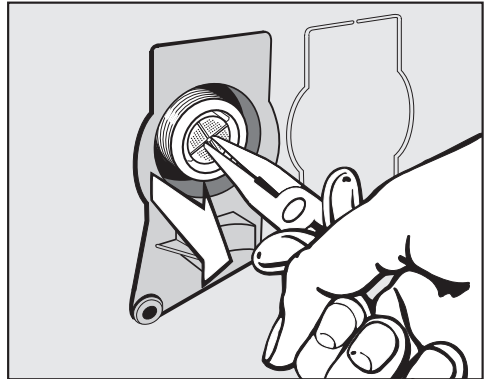

- Use pointed pliers to withdraw the plastic filter by the bar (see illustration).
- Clean the filter and the plastic nut (seal).
- Put the filter and plastic nut (seal) back in the reverse order and reconnect the hose.

The filters must be put back in place after cleaning.

- Turn on the tap.

Make sure there is no water leaking from the connections.

Problem solving guide



With the help of the following guide, minor faults in the performance of the appliance, some of which may result from incorrect operation, can be remedied without contacting Miele. This will save you time and money because you won't need a service call.

Please note that a call-out charge will be applied to unnecessary service visits where the problem could have been rectified as described in these operating instructions.

The programme does not start

Problem	Possible cause and remedy
The control panel remains dark.	There is no power to the machine. <ul style="list-style-type: none">■ Check whether the mains plug is plugged in and switched on.■ Check whether the circuit breaker has tripped.
	The washing machine has switched off automatically to save energy. <ul style="list-style-type: none">■ Turn the programme selector to switch the washing machine back on.
F and 34 alternately appear in the time display.	The door is not closed properly. The door lock could not engage. <ul style="list-style-type: none">■ Close the door again.■ Start the programme again. If the fault message appears again, contact Miele.

The programme is cancelled and a fault indicator light lights up in the control panel.

Problem	Possible cause and remedy
The fault indicator light  lights up, F and // appear alternately in the time display and the buzzer sounds.	<p>The water outlet is blocked or restricted. The drain hose has been fixed too high.</p> <ul style="list-style-type: none"> ■ Clean the drain filter and the pump. ■ The maximum drain height is 1 m.
The fault indicator light  lights up, F and 10 appear alternately in the time display and the buzzer sounds.	<p>The water inlet is blocked or restricted.</p> <ul style="list-style-type: none"> ■ Check whether the tap is turned on properly. ■ Check whether the inlet hose is kinked. ■ Check whether there is sufficient water pressure.
	<p>The filter in the water inlet is blocked.</p> <ul style="list-style-type: none"> ■ Clean the filter.
The fault indicator light  lights up, F and 138 appear alternately in the time display and the buzzer sounds.	<p>The water protection system has reacted.</p> <ul style="list-style-type: none"> ■ Turn off the tap. ■ Call Miele.
F and XXX appear alternately in the time display and the buzzer sounds.	<p>There is a fault.</p> <ul style="list-style-type: none"> ■ Disconnect the washing machine from the electricity supply. Switch off at the wall and withdraw the plug from the socket, or switch off the mains circuit breaker. ■ Wait at least 2 minutes before reconnecting the washing machine to the electricity supply. ■ Then switch the washing machine on again. ■ Restart the programme. If the fault message appears again, contact Miele.

Problem solving guide

During the programme, a symbol appears in the time display

Message	Possible cause and remedy
-U- lights up	The programme selector was moved to a different position after the programme had started. <ul style="list-style-type: none">■ Turn the programme selector back to the original position.

At the end of the programme, an indicator light lights up in the control panel



Problem	Possible cause and remedy
The indicator light  lights up.	Excessive foam has built up during washing. <ul style="list-style-type: none">■ Use less detergent next time and follow the manufacturer's instructions on dosage given on the packaging.
The i indicator light lights up and ! appears in the time display.	A wash programme using a temperature above 60°C has not been run for a long time. <ul style="list-style-type: none">■ Run the <i>Cottons</i> 90°C programme using Miele IntenseClean machine cleaner or a universal powder detergent. <p>This will clean the washing machine and prevent a build-up of bacteria and odours.</p>

General problems with the washing machine

Problem	Possible cause and remedy
<p>The washing machine smells.</p>	<p>The i indicator light was ignored. A wash programme using a temperature above 60°C has not been run for a long time.</p> <ul style="list-style-type: none"> ■ In order to prevent bacteria and unpleasant odours building up in the washing machine, run the <i>Cottons</i> 90°C programme using Miele IntenseClean machine cleaner or a universal powder detergent. <p>The detergent dispenser drawer was left closed after washing.</p> <ul style="list-style-type: none"> ■ Leave the detergent dispenser drawer slightly open to allow it to dry.
<p>The machine shakes during the spin cycle.</p>	<p>The machine feet are not level.</p> <ul style="list-style-type: none"> ■ Level the machine and adjust the feet correctly.
<p>The laundry has not been spun properly and the laundry is still wet.</p>	<p>The machine detected an imbalance during the final spin and reduced the spin speed automatically.</p> <ul style="list-style-type: none"> ■ Include both large and small items in the load as this will give better distribution.
<p>The pump makes strange noises.</p>	<p>This is not a fault. These slurping noises occur at the end of the pump sequence as a normal part of operation.</p>
<p>Large amounts of detergent residue remain in the detergent dispenser drawer.</p>	<p>The water pressure is too low.</p> <ul style="list-style-type: none"> ■ Clean the filter in the water inlet. ■ It may be useful to select the <i>Water + Extra</i>. <p>Powder detergent used with water softeners can be sticky.</p> <ul style="list-style-type: none"> ■ Clean the detergent dispenser drawer and in future add washing powder and then add the water softener.

Problem solving guide

General problems with the washing machine

Problem	Possible cause and remedy
Fabric softener is not completely dispensed or too much water remains in the  compartment.	<p>The siphon tube is not correctly positioned, or is clogged up.</p> <ul style="list-style-type: none">■ Clean the siphon (see “Cleaning and care - Cleaning the detergent dispenser drawer”).
At the end of the programme there is still liquid in the capsule.	<p>The small pipe in the detergent dispenser drawer onto which the capsule is placed is blocked.</p> <ul style="list-style-type: none">■ Clean the small pipe.
	<p>This is not a fault. For technical reasons, a small amount of water will remain in the capsule.</p>
There is water next to the capsule in the  compartment.	<p>CapDosing has not been activated.</p> <ul style="list-style-type: none">■ Make sure that you remember to activate CapDosing with the  sensor the next time you insert a capsule.
	<p>An empty capsule was not removed at the end of the last wash programme.</p> <ul style="list-style-type: none">■ Remove and dispose of the empty capsule at the end of each programme.
	<p>The small pipe in the detergent dispenser drawer onto which the capsule is placed is blocked.</p> <ul style="list-style-type: none">■ Clean the small pipe.

An unsatisfactory wash result

Problem	Possible cause and remedy
<p>Liquid detergent does not give the required result.</p>	<p>Liquid detergents usually contain no bleaching agents. They do not remove fruit, coffee and tea stains.</p> <ul style="list-style-type: none"> ■ Use a general purpose powder detergent containing a bleaching agent. ■ Use the appropriate capsule or add stain removers to the  compartment. ■ Never put stain removers and liquid detergent together in the dispenser drawer.
<p>Grey, greasy particles cling to washed laundry.</p>	<p>Insufficient amounts of detergent were used to break down the particles of grease in heavily soiled laundry.</p> <ul style="list-style-type: none"> ■ Use more detergent or liquid detergent. ■ Before washing the next load, run a <i>Cottons 60°C</i> programme with powder detergent but without a load.
<p>White residues which look like powder detergent are seen on dark textiles after washing.</p>	<p>The detergent contained compounds (zeolites) to aid water softening which are not soluble in water. These have ended up on the laundry.</p> <ul style="list-style-type: none"> ■ Try and brush off the residues with a soft brush once the laundry is dry. ■ Wash dark textiles using a detergent which does not contain zeolites. Liquid detergents usually do not contain zeolites. ■ Use the <i>Dark garments/Denim</i> programme.

Problem solving guide

The door will not open

Problem	Possible cause and remedy
The door cannot be pulled open during a programme.	The drum is locked during a programme. ■ Follow the instructions in "5. Starting the programme – Adding laundry during a programme sequence".
After the programme is cancelled, flashing bars <i>l j</i>...<i>l j</i>...<i>l j</i>... appear in the time display.	For safety reasons, the door cannot be opened if the suds temperature is higher than 55°C. ■ Wait until the temperature in the drum has decreased and the bars have stopped flashing in the display.
<i>F</i> and <i>35</i> alternately appear in the time display.	The door lock has jammed. ■ Call Miele.

Opening the door in the event of a blocked drain outlet and/ or power cut

- Switch off the washing machine.



- Open the drain pump access panel.

Blocked drain outlet

If the drain outlet is blocked, a larger quantity of water can remain in the washing machine.

 Risk of scalding due to hot suds. Escaping suds will be hot if laundry has been washed at high temperatures!
Carefully allow all suds to drain off.

Procedure for draining the machine

When removing the drain filter, do not remove it completely.

- Place a suitable container under the access panel, e.g. a universal oven tray.

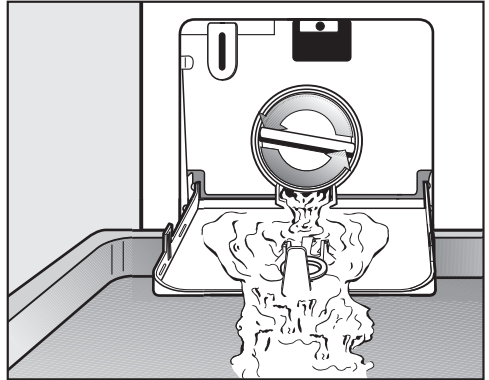

- Slowly and carefully unscrew the filter to let the water out. Be careful not to release too much water at once. If the flow of water is too strong, some water can seep into the washing machine base and activate the water protection system. This will prevent the washing machine from functioning.
- Tighten the drain filter back up again if you need to interrupt the flow of water.

Once the flow of water ceases:

Problem solving guide

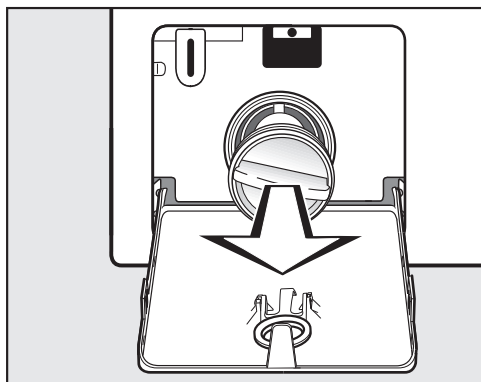

- Remove the drain filter completely.

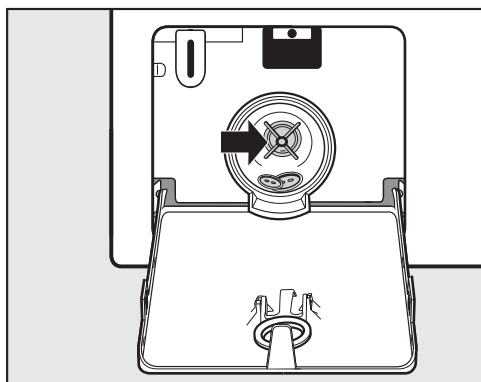

- Clean the drain filter thoroughly.
- Remove any foreign objects (e.g., buttons, coins etc.) and clean the interior. Turn the impeller by hand to check that it rotates freely.
- Replace the drain filter correctly and tighten it securely.
- Close the drain pump access panel.

 Risk of water damage.

Make sure the drain filter is securely tightened. Otherwise there is a risk of water leakage during use.

Replace the drain filter correctly and tighten it securely.

Opening the door

 Danger of injury due to rotating drum!

Reaching into a moving drum is extremely dangerous. Danger of injury!

Always make sure that the drum is stationary before reaching in to remove laundry.

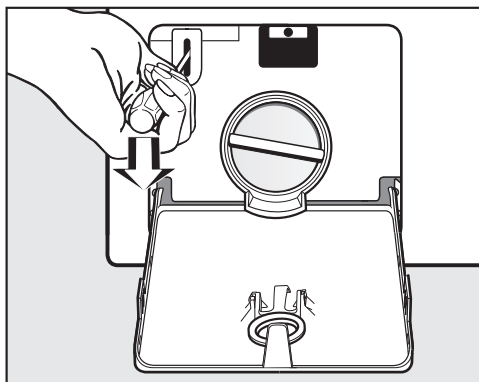

- Use a screwdriver to unlock the door of the machine as shown.
- Pull open the door.

Contact in case of fault

In the event of any faults which you cannot remedy yourself, please contact Miele.

You can book a Miele customer service call-out online at www.miele.com.au/service or www.miele.co.nz/service.

Contact information for Miele can be found at the end of this booklet.

Please quote the model and serial number of your appliance when contacting Miele. This information can be found on the data plate.

The data plate is found above the porthole glass when the door is opened.

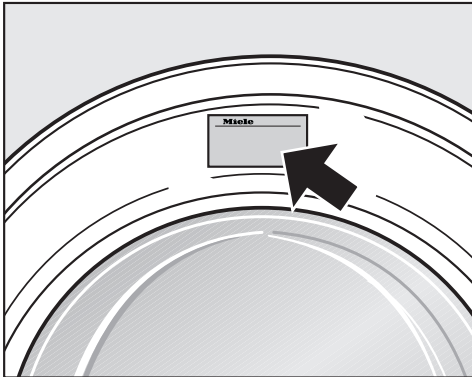

Optional accessories

Optional spare parts and accessories for this washing machine are available from Miele.

Warranty

The manufacturer's warranty for this appliance is 2 years.

For further information, please refer to your warranty booklet.

Installation

Front view



- ① Inlet hose (tested to withstand pressures up to 7000 kPa)
- ② Electrical connection
- ③ Flexible drain hose (with detachable swivel elbow)
- ④ Control panel

- ⑤ Detergent dispenser drawer
- ⑥ Door
- ⑦ Access to filter, pump and emergency release
- ⑧ Four height-adjustable feet

Rear view

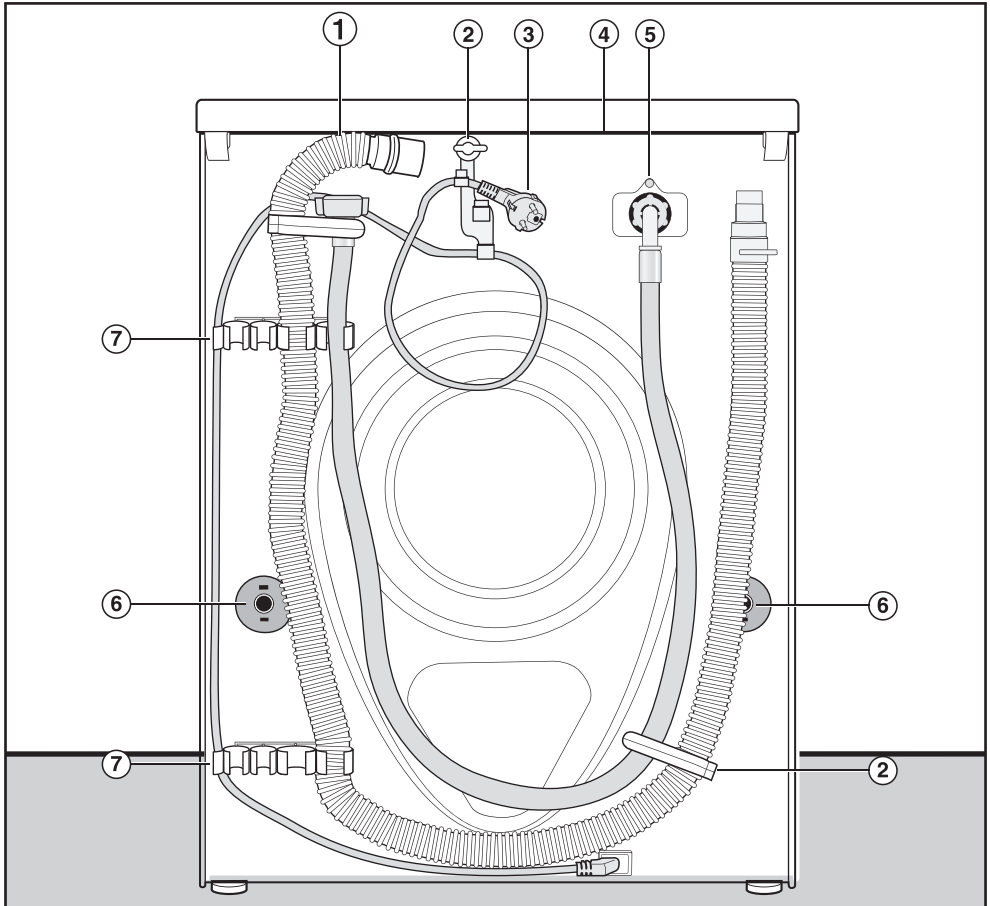

- ① Drain hose
- ② Transport clips for inlet and drain hoses and mains connection cable
- ③ Electrical connection
- ④ Protruding lid for holding when moving the machine
- ⑤ Inlet hose (tested to withstand pressures up to 7000 kPa)
- ⑥ Safety caps for transit bars
- ⑦ Transport clips for inlet and drain hoses and for storing transit bars when not in use

Installation

Installation surface

A concrete floor is the most suitable installation surface. It is far less prone to vibration during the spin cycle than wooden floorboards or a carpeted surface.

Please note:

- The machine must be level and securely positioned.
- To avoid vibrations during spinning, the machine should not be installed on soft floor coverings.

If installing on a wooden joist floor:

- Install the machine on a plywood base (at least 59 x 52 x 3 cm). The base should span several joists and be bolted to the joists and not only to the floorboards. Check for the presence of pipes and cables first.

Useful tip: If possible, install the machine in a corner. This is usually the most stable part of the floor.

Transporting the washing machine to its installation site

 Danger of injury due to unsecured lid.

Make sure the fixings at the back of the lid are secure. They may become brittle due to external circumstances. There is a danger of the lid being pulled off when carrying the appliance.

Before carrying the appliance, check that the lid is secure where it protrudes at the back.

- Carry the washing machine by the front feet and by the lid where it protrudes at the back of the appliance.

Removing the transit bars

Removing the left transit bar

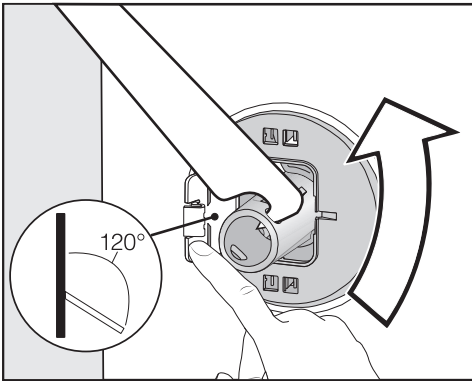

- Push the flap outwards and turn the transit bar 90° using the enclosed spanner.

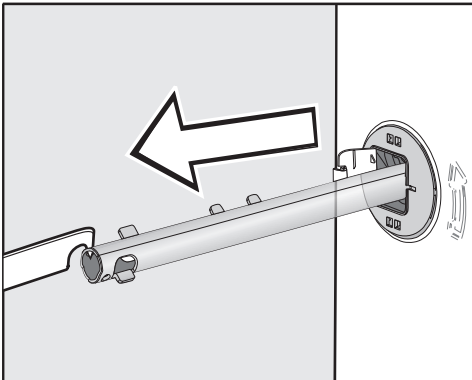

- Then pull the transit bar out.

Removing the right transit bar

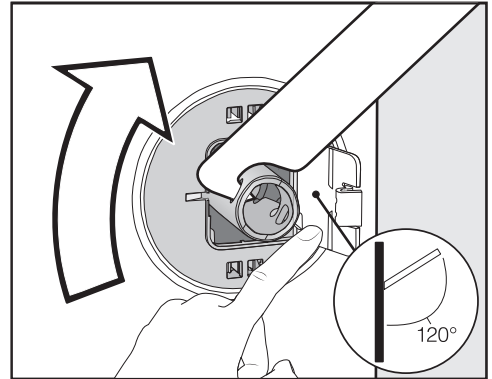

- Push the flap outwards and turn the transit bar 90° using the enclosed spanner.

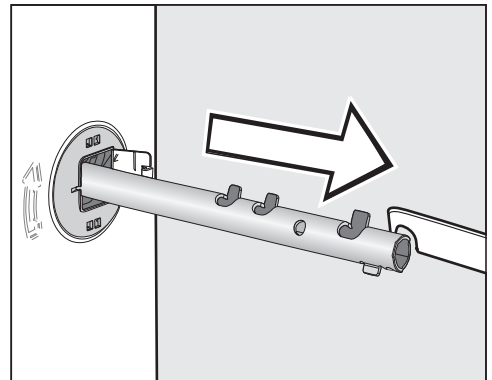

- Then pull the transit bar out.

Installation

Covering the holes

 Risk of injury from sharp edges!
There is a risk of injury from reaching into holes that are not covered.
To avoid the risk of injury, the holes for the transit bars must be covered after the transit bars have been removed.

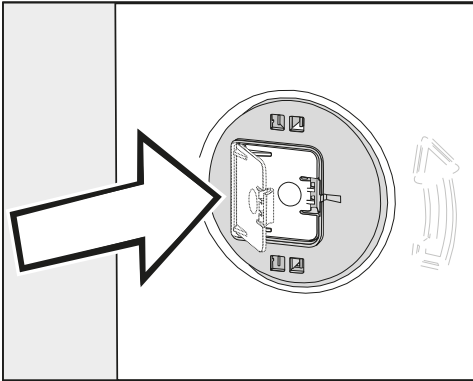

- Press the flaps firmly shut until they click into place.

Securing the transit bars

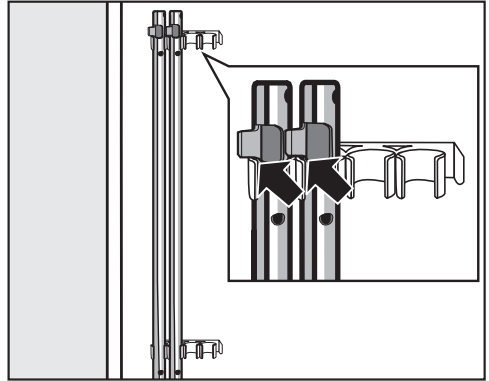

- Secure the transit bars to the back of the washing machine. Make sure that the top catch is located above the holder.

 Risk of damage from incorrect transport.

The washing machine may become damaged if moved without the transit bars in place.

Keep the transit bars in a safe place. Fit them again if the machine is to be moved (e.g. when moving house).

Fitting the transit bars

Opening the flaps



- Push against the catch with a pointed object, e.g. a narrow screwdriver.

The flap will open.

Fitting the transit bars

- Install the transit bars in reverse order to their removal.

Useful tip: If you lift the drum slightly, the transit bars can be pushed in more easily.

Installation

Levelling the machine

The washing machine must stand perfectly level on all four feet to ensure safe and proper operation.

Incorrect installation may increase electricity and water consumption and may cause the machine to move about.

Screwing out and adjusting the feet

The four adjustable screw feet are used for levelling the washing machine. All four feet are screwed in when the appliance is delivered.

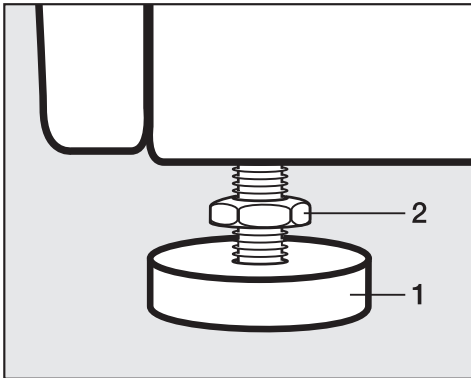

- Using the spanner supplied, turn counter nut **2** in a clockwise direction. Then turn counter nut **2** together with foot **1** to unscrew.

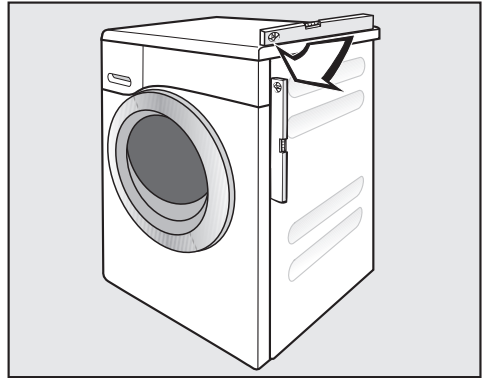

- Use a spirit level to check that the washing machine is standing level.
- Hold foot **1** securely with a pipe wrench. Turn counter nut **2** again using the spanner supplied until it sits firmly up against the housing.

 Risk of damage due to incorrectly aligned washing machine.

There is a danger of the washing machine moving about if the feet are not secured.

Turn all four counter nuts for the feet until they sit firmly up against the housing. Please also check this for the feet which did not need adjustment.

Installing under a continuous worktop

⚠ Risk of electric shock due to exposed cables.

There is a risk of coming into contact with live parts while the lid is removed.

The fitting of cover plates and stacking kits must only be undertaken by qualified and competent persons, in accordance with the instructions supplied with the kit.

- A special building under conversion kit* is required. The machine lid must be replaced by a cover plate. To ensure electrical safety, the cover plate must be fitted.*

- N.B.*

If you wish to push your machine under a worktop and there is space to do this **without removing the lid**, the conversion kit is not necessary. Otherwise the conversion kit is essential.

- Connections for electricity, water and drainage should be installed in such a way that they remain accessible when the machine is in place.

Fitting instructions are supplied with the conversion kit.

Washer and dryer stack

A Miele tumble dryer can be stacked with the washing machine. The appropriate "WTV" stacking kit* to match your tumble dryer is required.

All parts marked * are available from Miele.

Please note:

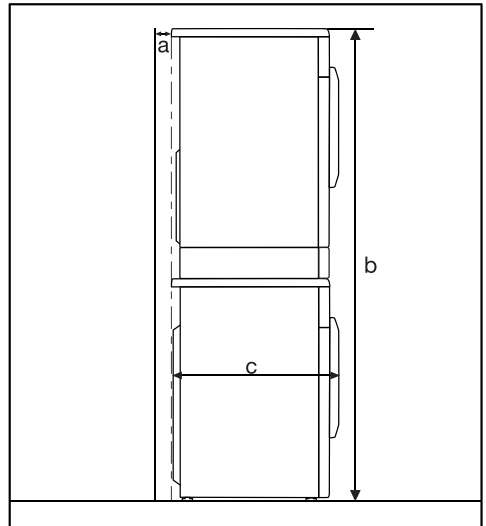

a = at least 2 cm

b = WTV without drawer: 172 cm
WTV with drawer: 181 cm

c = 64 cm

Installation

The Miele water protection system

The Miele water protection system protects all parts of the washing machine and surrounds from water damage.

The system consists of three main components:

- the inlet hose
- the electronic unit and drainage and overflow protection
- the drain hose

Inlet hose

- Protection against bursting
The inlet hose is tested to withstand pressures up to 7000 kPa.

Electronic unit and washing machine housing

- Sump: Any leaking water is collected in a sump in the base of the machine. A float switches off the water inlet valves, preventing any more water from flowing into the machine and water in the suds container is pumped away.
- Overflow protection: This prevents the washing machine taking in too much water. If the water level exceeds a certain level, the drain pump switches on and pumps the excess water away in a controlled way.

Drain hose

The drain hose is protected by a ventilation system which prevents the washing machine from being emptied completely.

Connection to the water supply

 Health risk and risk of damage due to contaminated mains water. The quality of the water used must correspond to the drinking water specification of the country in which the washing machine is being operated. Always connect the washing machine to potable water.

The washing machine must be connected to a mains water supply in accordance with current local and national safety regulations.

The water connection pressure needs to be between 100 kPa (1 bar) and 1000 kPa (10 bar). If the water connection pressure exceeds 1000 kPa, a pressure reducing valve must be installed.

A tap with a 3/4 inch threaded union is required for the connection.

The connection point is subject to mains water pressure. Turn on the tap slowly and check for leaks. Correct the position of the washer and union if necessary.

The washing machine is not suitable for connection to a hot water supply.

Maintenance

Only use a genuine Miele hose should you ever need a replacement. These are tested to withstand pressures up to 7000 kPa.



A filter is located in the open end of the inlet hose and another in the intake point to protect the inlet valve. The filters must remain in place, and be replaced after cleaning.

Hose extension

Longer hoses 2.5 m or 4.0 m in length are available from Miele as optional accessories (depending on country).

Installation

Drainage

The suds are drained through a drain pump with a 1 m delivery head. For the water to drain freely, the hose must be installed free of kinks.

If required, the hose can be extended to a length of up to 5 m.

For a delivery head of more than 1 m (up to a max. of 1.8 m) a replacement drain pump will need to be fitted.

Please contact Miele for advice.

For a delivery head of 1.8 m the hose can be extended to a length of up to 2.5 m.

The necessary parts can be purchased from Miele.

Drain hose connection options

1. Directed into a laundry trough or tub or into the sud-saver pipe of a laundry trough or tub.

Please note:

- Hook the hose over the edge and secure it.
- Make sure that the water can drain away freely without hindrance. Otherwise there is a risk of water overflowing or of some of the drained water being sucked back into the machine.

2. Connected securely to a trapped waste pipe.
3. Connected securely to a floor drain (gully).

Please note:

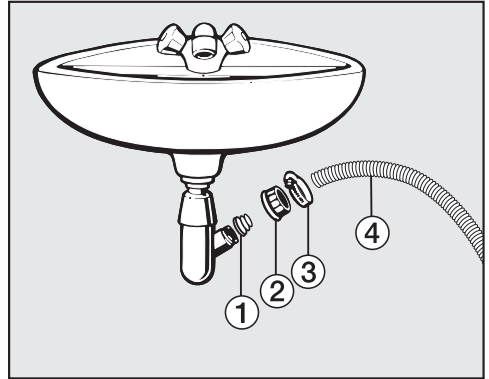

- ① Adapter
- ② Nut
- ③ Hose clip
- ④ End of the hose

- Fit the adapter ① to the sink drain outlet using the nut ②.
- Attach the end of the hose ④ to the adapter ①.
- Use a screwdriver to tighten the hose clip ③ up close to the nut.

Electrical connection

The washing machine is supplied with a mains cable with moulded plug ready for connection to a switched socket.

The socket must be easily accessible after the machine has been installed. If the switch is not accessible after installation an additional means of disconnection must be provided for all poles.



Risk of fire from overheating!

Connecting the washing machine to a multi-socket plug adapter or to an extension lead can overload the cable.

Do not use an extension lead or multi-socket plug adapter.

All electrical work must be carried out by a suitably qualified and competent person, in strict accordance with national and local safety regulations. For extra safety, it is advisable to install a residual current device (RCD) with a trip current of 30 mA. Ensure power is not supplied to the appliance until after the installation has been completed. Connection should be made via a suitable switched socket.

If the connection cable is damaged, it must only be replaced with a specific connection cable of the same type (available from Miele) in order to avoid a hazard. For safety reasons, such replacement may only be carried out by a suitably qualified and competent technician or Miele.

The data plate indicates the nominal power consumption and the appropriate fuse rating. Compare the specifications on the data plate with those of the mains electricity supply.

If in any doubt, consult a qualified electrician.

Do not connect the washing machine solely to a stand-alone inverter such as those used with an autonomous energy source, e.g. solar power. When the washing machine is switched on, power surges could result in a safety switch-off. This could damage the electronics.

The machine must not be used with so-called energy-saving devices either. These reduce the amount of energy supplied to the machine, causing it to overheat.

WARNING: THIS APPLIANCE MUST BE EARTHED

Technical data

Height	850 mm
Width	596 mm
Depth	636 mm
Depth with door open	1054 mm
Height for building under	820 (+8/-2) mm
Width for building under	600 mm
Depth for building under	600 mm
Weight	Approx. 85 kg
Capacity	7.0 kg dry laundry
Supply voltage	see data plate
Rated load	see data plate
Fuse rating	see data plate
Minimum water flow pressure	100 kPa (1 bar)
Maximum water flow pressure	1000 kPa (10 bar)
Water inlet hose length	1.60 m
Drain hose length	1.50 m
Mains connection cable length	2.00 m
Drain pump head height max.	1.00 m
Drain pump length max.	5.00 m
LEDs	Class 1
Test certifications awarded	see data plate
Power consumption when switched off	0.30 W

Programmes	Load kg	Energy kWh	Water Litres	Duration h:min	Temperature ¹ °C	Residual moisture %	Speed rpm
Cottons	60	1.20	50	2:29	54	53	1400
	20	0.35	69	2:39	24	53	1400
Minimum iron	30	0.45	52	1:59	33	30	1200
Express 20 ²	40	0.34	30	0:20	27	60	1200
Woolens 	30	0.23	35	0:39	-	-	1200

1 Maximum laundry temperature reached in main wash.

2 Short Extra activated

Information for customers:

Consumption data can vary from the nominal values listed depending on water pressure, water hardness, water inlet temperature, room temperature, type and volume of load, fluctuations in the electricity supply and any Extras selected.

Programmable functions

The programmable functions are used to alter the machine's electronics to suit changing requirements. Programmable functions can be altered at any time.

Opening the programming level

Programming is carried out in 8 steps (1, 2, 3 ... 8) using the sensors.

Before you begin, ensure the following:

- The washing machine is switched on (the programme selector is pointing to a wash programme).
- The washing machine door is open.

1 Touch the ►|| sensor and hold it down while carrying out steps 2 and 3.

2 Close the washing machine door.

Wait until *Start/Add laundry* lights up constantly ...

3 ... and then release the ►|| sensor.

P13 will light up in the time display.

Choosing and selecting programmable functions

The number of the programmable function will appear in the time display as *P* and a number: e.g. *P13*.

- 4 Touch the ▲ sensor to select the other programmable functions one by one:

Programmable functions	
<i>P13</i>	Keypad tone
<i>P14</i>	PIN Code
<i>P22</i>	Indicator switch-off status
<i>P24</i>	Memory
<i>P26</i>	Longer pre-wash Cottons
<i>P27</i>	Soak duration
<i>P28</i>	Gentle action
<i>P29</i>	Reduce temperature
<i>P30</i>	Water plus
<i>P31</i>	Water plus level
<i>P32</i>	Maximum rinse level
<i>P33</i>	Suds cooling
<i>P34</i>	Anti-crease
<i>P49</i>	Low water pressure

- Confirm the selected programmable function by touching the ►|| sensor.

Editing and saving the programmable function

You can switch a programmable function on or off or select different options.

- 6 Touch the ▲ sensor to switch the programmable function on/off or to select an option:

Programmable function	Available options				
	-00	-01	-02	-03	-04
P13	●	✓			
P14	✓	●			
P22	✓	●			
P24	✓	●			
P26	✓	●	●	●	
P27	✓	●	●	●	
P28	✓	●			
P29	✓	●			
P30		✓	●	●	
P31		✓	●	●	●
P32	✓	●			
P33	✓	●			
P34	✓	●			
P49	✓	●			

- = can be selected
- ✓ = factory default setting

- 7 Touch the ► sensor to confirm your selection.

The number of the programmable function, e.g. P13, will light up again.

Exiting the programming level

- 8 Turn the programme selector to ⏻.

The settings have been changed. You can alter the settings again at any time.

P13 Keypad tone

Each touch of a sensor is confirmed with an audible tone.

Options

- 00 = Keypad tone is switched off
- 01 = Keypad tone is switched on
(factory default setting)

Programmable functions

P14 PIN Code

The PIN code prevents the washing machine being used without your knowledge.

When the code has been activated, you have to enter a code after switching the washing machine on. Otherwise the washing machine cannot be operated.

Options

-00 = PIN code is switched off
(factory default setting)

-01 = PIN code is switched on

Using the washing machine with a PIN code

The code is **125** and cannot be altered.

- Switch on the washing machine.

The time display shows 0__ and 0 flashes to prompt you to enter the code.

- Touch the ▲ sensor.

__ / appears in the time display.

- Confirm the number with the ►|| sensor.

The first number has been saved and you can now enter the second number using the ▲ sensor.

- Enter the second and third numbers and confirm the numbers with the ►|| sensor.

The lock function is deactivated. A wash programme can now be selected and started.

P22 Indicator switch-off status

The indicators will switch off after 10 minutes to save energy.

Options

-00 = Off **(factory default setting)**
The indicators will remain lit up while the washing machine is switched on.

-01 = On
The indicators will switch off after 10 minutes if the programme is started.

However, the indicators will remain lit up for 10 minutes after a Delay start time has elapsed, after the end of a programme or at the end of the Anti-crease phase.

P24 Memory

The washing machine will save the last settings (temperature, spin speed and some of the Extras) selected for a programme after the programme has started.

When the programme is chosen again, the saved settings will appear in the display.

Options

- 00 = Memory is switched off
(factory default setting)
- 01 = Memory is switched on

P25 Longer pre-wash Cottons

If you require a longer pre-wash you can extend the pre-wash time.

Options

- 00 = **No** increase in the pre-wash time
(factory default setting)
- 01 = **+ 6 minutes** increase in the pre-wash time
- 02 = **+ 9 minutes** increase in the pre-wash time
- 03 = **+ 12 minutes** increase in the pre-wash time

P27 Soak duration

You can set a duration for the soak process of between 30 minutes and 2 hours.

A duration can be selected in 30-minute increments. When the *Soak Extra* is selected, the laundry will be soaked for the duration selected.

Options

- 00 = **30 minutes** soak duration
(factory default setting)
- 01 = **1 hour** soak duration
- 02 = **1 hour 30 minutes** soak duration
- 03 = **2 hours** soak duration

P28 Gentle action

With gentle action activated, drum agitation is reduced. In this way, lightly soiled items can be washed more gently.

Gentle action can be activated for the *Cottons* and the *Minimum iron* programmes.

Options

- 00 = Gentle action is switched off
(factory default setting)
- 01 = Gentle action is switched on

Programmable functions

P29 Reduce temperature

At high altitudes water has a lower boiling point. Miele recommends activating the Reduce temperature setting at altitudes of or above 2000 m to prevent water from boiling. The max. temperature is reduced to 80°C, even if a higher temperature is selected.

Options

- 00 = The Reduce temperature setting is switched off (**factory default setting**)
- 01 = The Reduce temperature setting is switched on

P30 Water plus

You can determine the amount of water used if the *Water + Extra* is selected.

Options

- 01 = More water is used in the wash and rinse stages (**factory default setting**)
- 02 = An extra rinse is carried out
- 03 = The water level in the wash and rinse stages is increased and an extra rinse is carried out

P31 Water plus level

There are three different water levels which can be selected by activating the *Water + Extra*.

Options

- 01 = No higher water level (**factory default setting**)
- 02 = Water level increased by 1 level when washing and rinsing
- 03 = Water level increased by 2 levels when washing and rinsing
- 04 = Water level increased by 3 levels when washing and rinsing

P32 Maximum rinse level

The water level in the rinse can be permanently set to the highest value.

This function is important for allergy sufferers as it achieves excellent rinse results. The water consumption will be increased.

Options

- 00 = Maximum rinse level is switched off (**factory default setting**)
- 01 = Maximum rinse level is switched on

P33 Suds cooling

When this is activated, additional water flows into the drum at the end of the main wash to cool the suds down. Hot suds can damage plastic drainage pipes.

Suds cooling takes place when a Cottons programme with a temperature of 70°C or higher is selected.

Suds cooling should be activated:

- to prevent the danger of scalding if the drain hose is hooked over the edge of a laundry tub or trough.
- where the drainage pipes are rated less than 70°C.

Options

- 00 = Suds cooling is switched off **(factory default setting)**
- 01 = Suds cooling is switched on

P34 Anti-crease

The Anti-crease function helps prevent creasing if laundry is not going to be removed immediately after the end of the programme.

At the end of the programme, the drum continues to turn at intervals for up to 30 min. The door can be opened at any time during the Anti-crease phase.

Options

- 00 = The Anti-crease function is switched off **(factory default setting)**
- 01 = The Anti-crease function is switched on

P49 Low water pressure

If the water pressure is below 100 kPa (1 bar), the washing machine cancels the programme and the  fault message appears.

If the water pressure cannot be increased, activating this function will prevent the programme from being cancelled.

Options

- 00 = Low water pressure is switched off **(factory default setting)**
- 01 = Low water pressure is switched on

Detergents and care products

Detergent, fabric care, additives and machine care products are available for this machine. All the products have been designed for Miele appliances.

These and many other useful products can be ordered via the internet at shop.miele.com (depending on country) or from Miele (see end of this booklet for contact details).

Detergent

UltraWhite (powder detergent)

- Best results at 20/30/40/60/95°C
- Radiant white laundry thanks to powerful formula with active oxygen
- Excellent stain removal even at low temperatures

UltraColor (liquid detergent)

- Best wash results at 20/30/40/60°C
- With colour-protection formula for brilliant colours
- Excellent stain removal even at low temperatures
- Also available as a powder detergent

WoolCare delicates detergent (liquid detergent)

- For wool, silks and delicates
- Special care complex based on wheat protein and with colour-protection formula
- Best wash results at 20/30/40°C

UltraDark (liquid detergent)

- For black and dark textiles
- With special colour-protection formula
- Anti-pilling effect protects your garments from discolouration
- Excellent stain removal even at low temperatures

Sensitive Skin (powder detergent)

- High quality detergent formulated for people with sensitive skin
- Contains no dyes and preservatives
- Most suitable for white or light coloured textiles

Specialist detergents

These specialist detergents are available as convenient single-use capsules.

Caps Sport

- For synthetic fabrics
- Neutralises odours thanks to built-in odour absorber
- Prevents static charge in clothes
- Retains the shape and breathability of synthetic fabrics

Caps DownCare

- For down-filled items
- Retains the elasticity and breathability of downs
- Lanolin for effective cleaning and gentle care
- Feathers do not stick together and stay fluffy

Caps WoolCare

- Woollens and delicates detergent
- Special care complex with wheat proteins
- Fibre protection technology to prevent felting
- Colour protection formula for gentle cleaning

Caps CottonRepair

- Special detergent for cotton fabrics
- Visibly renews fabric with just one wash
- Special Miele formula with Novozymes technology
- Removes pilling and renews colour intensity and brightness
- Depending on fabric do not use more than 1–2 times per year

Detergents and care products

Fabric care

These fabric care products are available as convenient single-use capsules.

Caps Fabric Softener

- Fabric softener for freshly scented laundry
- Pure and thorough cleanliness with a fresh scent
- For cuddly soft laundry
- Prevents static charge in clothes

Additive

The additive is available as a convenient single-use capsule.

Caps Booster

- Highly effective stain remover
- Enzyme technology to help remove stubborn stains
- Suitable for whites and colours
- For excellent wash results even at low temperatures

Machine care products

Descaling agent

- Removes heavy limescale deposits
- Mild and gentle with natural citric acid
- Gentle on heater elements, drum and other components

IntenseClean

- For hygienic cleanliness in washing machines
- Removes grease, bacteria and unpleasant odours
- Effective thorough cleaning

Miele Australia Pty. Ltd.

ACN 005 635 398
ABN 96 005 635 398

Miele Head Office Melbourne:

1 Gilbert Park Drive
Knoxfield, VIC 3180

Miele Experience Centre Doncaster:

1136/7 Doncaster Shopping Centre
619 Doncaster Rd, Doncaster, VIC 3108

Miele Experience Centre South Melbourne:

206-210 Coventry Street
South Melbourne, VIC 3205

Miele Experience Centre and Office Sydney:

3 Skyline Place
Frenchs Forest, NSW 2086

Miele Experience Centre and Office Brisbane:

Tenancy 4C, 63 Skyring Terrace
Newstead, QLD 4006

Miele Experience Centre Gold Coast:

131 Ferry Road
Southport, QLD 4215

Miele Experience Centre and Office Adelaide:

83-85 Sir Donald Bradman Drive
Hilton, SA 5033

Miele Experience Centre and Office Perth:

205-207 Stirling Highway
Claremont, WA 6010

1300 464 353 (1300 4 MIELE)

www.miele.com.au

Miele New Zealand Limited

IRD 98 463 631

**Miele Experience Centre
and Head Office Auckland:**

8 College Hill
Freemans Bay, Auckland 1011

**Miele Experience Centre
Wellington:**

183 Featherston Street
Wellington 6011

0800 464 353 (0800 4 MIELE)

www.miele.co.nz

**Miele Global Headquarters
Germany**

Miele & Cie. KG

Carl-Miele-Straße 29
33332 Gütersloh
Federal Republic of Germany

WCA 020

en-AU, NZ



M.-Nr. 11 637 110 / 02