

# Nikon

DIGITAL CAMERA

# Z 8

## User's Manual

En

- Read this document thoroughly before using the camera.
- To ensure proper use of the camera, be sure to read "For Your Safety" (page 8).
- After reading this document, keep it readily accessible for future reference.



Scan for detailed operating instructions.

nikon reference guide Z 8



# Before You Begin

## The Z 8 User's Manual and Reference Guide

In addition to this *User's Manual*, a *Reference Guide* is available for your camera.

### The User's Manual (This Document)

The *User's Manual* describes basic camera operations.



### The Reference Guide

Camera features and operations are detailed in a *Reference Guide*, a supplement to the *User's Manual*. The *Reference Guide* can be viewed on computers, smartphones, and tablets.



#### View the *Reference Guide* (Web Edition):



<https://onlinemanual.nikonimglib.com/z8/en/>



#### Download the *Reference Guide* (PDF Edition):



---

### Using Lenses

For more information on using lenses, consult lens documentation available from the Nikon Download Center.

---

### Z 8 Model Name: N2120

## The Nikon Download Center

Documentation for digital cameras, NIKKOR lenses, and flash units is available from the Nikon Download Center, as are firmware updates and NX Studio and other software.

<https://downloadcenter.nikonimglib.com/>



## Downloading Nikon Software

### ● Computer Software

Nikon software is available from the Nikon Download Center.

**NX Studio:** View and edit photos and videos shot with Nikon digital cameras.

### ● Smart Device Apps

Smart device apps are available from the Apple App Store® and on Google Play™.

**SnapBridge:** Download photos and videos to your smart device via a wireless connection.

---

### Tip: Nikon User Support

Should you need technical support, we offer a number of options.

- **For users in the U.S.A.:** <https://www.nikonusa.com/>
  - **For users in Canada:** <https://www.nikon.ca/>
  - **For users in Mexico:** <https://www.nikon.com.mx/>
  - **For users in Latin America:** <https://www.nikonamericalatina.com/>
  - **For users in Europe:** <https://www.europe-nikon.com/support>
  - **For users in Asia, Oceania, the Middle East, and Africa:**  
<https://www.nikon-asia.com/>
-

## Package Contents

Be sure all items listed here were included with your camera.

- Camera body

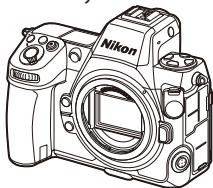



- BS-1 accessory shoe cover (comes attached to camera)
  - DK-33 rubber eyecup (comes attached to camera)
  - BF-N1 body cap
  - EN-EL15c rechargeable Li-ion battery with terminal cover
  - MH-25a battery charger (comes with either an AC wall adapter or power cable of a type and shape that varies with the country or region of sale)
  - HDMI/USB cable clip
  - AN-DC26 strap
  - UC-E24 USB cable
  - *User's Manual*
  - Warranty (printed on the back cover of this manual)
- Memory cards are sold separately.

# About This Document

## Symbols

This document employs the following symbols. Use them to help locate the information you need.

	This icon marks notes, information that should be read before using this product.
Tip	This icon marks tips, additional information you may find helpful when using this product.
	This icon marks references to other sections in this document.

## Conventions

- This camera uses CFexpress (Type B), XQD, SD, SDHC, and SDXC memory cards. Memory cards of all types are referred to throughout this document as “memory cards”. Where it is necessary to distinguish between the different types, the terms “CFexpress memory card”, “XQD memory card”, and “SD memory card” may be used.
- Throughout this document, battery chargers are referred to as “battery chargers” or “chargers”.
- Throughout this document, the display in camera monitor and viewfinder during shooting is referred to as the “shooting display”. In most cases, the illustrations show the monitor.
- Throughout this document, smartphones and tablets are referred to as “smart devices”.
- Throughout this document, “FX format” and “FX” are used in reference to an angle of view equivalent to that of a 35 mm format (“full frame”) camera and “DX format” and “DX” to an angle of view equivalent to that of an APS-C camera.
- Throughout this document, the term “default settings” is used to refer to the settings in effect at shipment. The explanations in this document assume that default settings are used.

# Table of Contents

## **Before You Begin** **2**

---

The Z 8 <i>User's Manual and Reference Guide</i> .....	2
Downloading Documentation and Software .....	3
The Nikon Download Center .....	3
Downloading Nikon Software .....	3
Package Contents .....	4
About This Document .....	5
Symbols .....	5
Conventions .....	5
For Your Safety .....	8
Notices .....	14

## **Parts of the Camera** **18**

---

Camera Body .....	18
-------------------	----

## **First Steps** **23**

---

Attaching the Strap .....	23
Charging the Battery .....	24
The Battery Charger .....	24
Optional Charging AC Adapters: Charging .....	26
Inserting the Battery .....	29
Removing the Battery .....	29
Battery Level .....	30
Inserting Memory Cards .....	31
Removing Memory Cards .....	33
Attaching a Lens .....	34
Detaching Lenses .....	35
Camera Setup .....	36

## **Basic Photography and Playback** **39**

---

Taking Photographs .....	39
Recording Videos .....	43
Playback.....	46

## **Troubleshooting** **47**

---

Before Contacting Customer Support.....	47
---	----

## **Technical Notes** **48**

---

Caring for the Camera .....	48
Long-Term Storage .....	48
Caring for the Camera and Battery: Cautions .....	49
Cautions: Using the Camera.....	49
Cautions: Using Batteries .....	54
Cautions: Using the Charger .....	57
Trademarks and Licenses .....	58
Notices .....	60
Bluetooth and Wi-Fi (Wireless LAN).....	63
Warranty Terms - Nikon Europe Service Warranty.....	71

## For Your Safety

To prevent damage to property or injury to yourself or to others, read "For Your Safety" in its entirety before using this product.

After reading these safety instructions, keep them readily accessible for future reference.

 **DANGER:** Failure to observe the precautions marked with this icon carries a high risk of death or severe injury.

 **WARNING:** Failure to observe the precautions marked with this icon could result in death or severe injury.

 **CAUTION:** Failure to observe the precautions marked with this icon could result in injury or property damage.

### **WARNING**

#### **Do not use while walking or operating a vehicle.**

Failure to observe this precaution could result in accidents or other injury.

#### **Do not disassemble or modify this product. Do not touch internal parts that become exposed as the result of a fall or other accident.**

Failure to observe these precautions could result in electric shock or other injury.

#### **Should you notice any abnormalities such as the product producing smoke, heat, or unusual odors, immediately disconnect the battery or power source.**

Continued operation could result in fire, burns or other injury.



 **WARNING**

**Keep dry. Do not handle with wet hands. Do not handle the plug with wet hands.**

Failure to observe these precautions could result in fire or electric shock.

---

**Do not let your skin remain in prolonged contact with this product while it is on or plugged in.**

Failure to observe this precaution could result in low-temperature burns.

---

**Do not use this product in the presence of flammable dust or gas such as propane, gasoline or aerosols.**

Failure to observe this precaution could result in explosion or fire.

---

**Do not directly view the sun or other bright light source through the lens.**

Failure to observe this precaution could result in visual impairment.

---

**Do not aim the flash or AF-assist illuminator at the operator of a motor vehicle.**

Failure to observe this precaution could result in accidents.

---

**Keep this product out of reach of children.**

Failure to observe this precaution could result in injury or product malfunction. In addition, note that small parts constitute a choking hazard. Should a child swallow any part of this product, seek immediate medical attention.

---

**Do not entangle, wrap or twist the straps around your neck.**

Failure to observe this precaution could result in accidents.

---

## **WARNING**

**Do not use batteries, chargers, or AC adapters not specifically designated for use with this product. When using batteries, chargers, and AC adapters designated for use with this product, do not:**

- **Damage, modify, forcibly tug or bend the cords or cables, place them under heavy objects, or expose them to heat or flame.**
- **Use travel converters or adapters designed to convert from one voltage to another or with DC-to-AC inverters.**

Failure to observe these precautions could result in fire or electric shock.

---

**Do not handle the plug when charging the product or using the AC adapter during thunderstorms.**

Failure to observe this precaution could result in electric shock.

---

**Dust on or near the metal parts of the plug should be removed with a dry cloth.**

Continued use could result in fire.

---

**Do not handle with bare hands in locations exposed to extremely high or low temperatures.**

Failure to observe this precaution could result in burns or frostbite.

---

## **CAUTION**

**Do not leave the lens pointed at the sun or other strong light sources.**

Light focused by the lens could cause fire or damage to product's internal parts. When shooting backlit subjects, keep the sun well out of the frame. Sunlight focused into the camera when the sun is close to the frame could cause fire.

---

 **CAUTION**

**Turn this product off when its use is prohibited. Disable wireless features when the use of wireless equipment is prohibited.**

The radio-frequency emissions produced by this product could interfere with equipment onboard aircraft or in hospitals or other medical facilities.

**Remove the battery and disconnect the AC adapter if this product will not be used for an extended period.**

Failure to observe this precaution could result in fire or product malfunction.

**Do not fire the flash in contact with or in close proximity to the skin or objects.**

Failure to observe this precaution could result in burns or fire.

**Do not leave the product where it will be exposed to extremely high temperatures, for an extended period such as in an enclosed automobile or in direct sunlight.**

Failure to observe this precaution could result in fire or product malfunction.

**Do not look directly at the AF-assist illuminator.**

Failure to observe this precaution could have adverse effects on vision.

**Do not transport cameras or lenses with tripods or similar accessories attached.**

Failure to observe this precaution could result in injury or product malfunction.

**Do not touch the camera or memory cards when a high-temperature warning is displayed in the monitor or viewfinder.**



The camera and memory cards will be hot, potentially causing burns or causing the cards or battery to be dropped and damaged when removed.

 **CAUTION**

**Keep the product at least 5 cm (2.0 in.) from pacemakers and other medical devices.**

Medical devices in close proximity could be affected by the magnet or magnets in the product.

 **DANGER (Batteries)**

**Do not mishandle batteries.**

Failure to observe the following precautions could result in the batteries leaking, overheating, rupturing, or catching fire:

- Use only rechargeable batteries approved for use in this product.
- Do not expose batteries to flame or excessive heat.
- Do not disassemble.
- Do not short-circuit the terminals by touching them to necklaces, hairpins, or other metal objects.
- Do not expose batteries or the products in which they are inserted to powerful physical shocks.
- Do not step on batteries, pierce them with nails, or strike them with hammers.

**Charge only as indicated.**

Failure to observe this precaution could result in the batteries leaking, overheating, rupturing, or catching fire.

**If battery liquid comes into contact with the eyes, rinse with plenty of clean water and seek immediate medical attention.**

Delaying action could result in eye injuries.

**Follow the instructions of airline personnel.**

Batteries left unattended at high altitudes in an unpressurized environment may leak, overheat, rupture, or catch fire.

**⚠ WARNING (Batteries)**

**Keep batteries out of reach of children.**

Should a child swallow a battery, seek immediate medical attention.

---

**Keep batteries out of reach of household pets and other animals.**

The batteries could leak, overheat, rupture, or catch fire if bitten, chewed, or otherwise damaged by animals.

---

**Do not immerse batteries in water or expose to rain.**

Failure to observe this precaution could result in fire or product malfunction. Immediately dry the product with a towel or similar object should it become wet.

---

**Discontinue use immediately should you notice any changes in the batteries, such as discoloration or deformation. Cease charging EN-EL15c rechargeable batteries if they do not charge in the specified period of time.**

Failure to observe these precautions could result in the batteries leaking, overheating, rupturing, or catching fire.

---

**When batteries are no longer needed, insulate the terminals with tape.**

Overheating, rupture, or fire may result should metal objects come into contact with the terminals.

---

**If battery liquid comes into contact with a person's skin or clothing, immediately rinse the affected area with plenty of clean water.**

Failure to observe this precaution could result in skin irritation.

---

## Notices

- No part of the documentation included with this product may be reproduced, transmitted, transcribed, stored in a retrieval system, or translated into any language in any form, by any means, without Nikon's prior written permission.
- Nikon reserves the right to change the appearance and specifications of the hardware and software described in this documentation at any time and without prior notice.
- Nikon will not be held liable for any damages resulting from the use of this product.
- While every effort has been made to ensure that the information in this documentation is accurate and complete, we would appreciate it were you to bring any errors or omissions to the attention of the Nikon representative in your area (address provided separately).

### ● **Notice Concerning Prohibition of Copying or Reproduction**

Note that simply being in possession of material that has been digitally copied or reproduced by means of a scanner, digital camera, or other device may be punishable by law.

#### ● **Items prohibited by law from being copied or reproduced**

Do not copy or reproduce paper money, coins, securities, government bonds, or local government bonds, even if such copies or reproductions are stamped "Sample".

The copying or reproduction of paper money, coins, or securities which are circulated in a foreign country is prohibited.

Unless the prior permission of the government has been obtained, the copying or reproduction of unused postage stamps or post cards issued by the government is prohibited.

The copying or reproduction of stamps issued by the government and of certified documents stipulated by law is prohibited.

- **Cautions on certain copies and reproductions**

The government has issued cautions on copies or reproductions of securities issued by private companies (shares, bills, checks, gift certificates, etc.), commuter passes, or coupon tickets, except when a minimum of necessary copies are to be provided for business use by a company. Also, do not copy or reproduce passports issued by the government, licenses issued by public agencies and private groups, ID cards, and tickets, such as passes and meal coupons.

- **Comply with copyright notices**

Under copyright law, photographs or recordings of copyrighted works made with the camera cannot be used without the permission of the copyright holder. Exceptions apply to personal use, but note that even personal use may be restricted in the case of photographs or recordings of exhibits or live performances.

- **Use Only Nikon Brand Electronic Accessories**

Nikon cameras include complex electronic circuitry. Only Nikon brand electronic accessories (including lenses, chargers, batteries, AC adapters, and flash accessories) certified by Nikon specifically for use with this Nikon digital camera are engineered and proven to operate within the operational and safety requirements of this electronic circuitry.

The use of non-Nikon electronic accessories could damage the camera and may void your Nikon warranty. The use of third-party rechargeable Li-ion batteries not bearing the Nikon holographic seal shown at right could interfere with normal operation of the camera or result in the batteries overheating, igniting, rupturing, or leaking.



For more information about Nikon brand accessories, contact a local authorized Nikon dealer.

## ● **Memory Cards**

- Memory cards may be hot after use. Observe due caution when removing memory cards from the camera.
- Do not perform the following operations during formatting or while data are being recorded, deleted, or copied to a computer or other device. Failure to observe these precautions could result in loss of data or in damage to the camera or card.
  - Do not remove or insert memory cards.
  - Do not turn the camera off.
  - Do not remove the battery.
  - Do not disconnect AC adapters.
- Do not touch the card terminals with your fingers or metal objects.
- Do not use excessive force when handling memory cards. Failure to observe this precaution could damage the card.
- Do not bend or drop memory cards or subject them to strong physical shocks.
- Do not expose memory cards to water, heat, or direct sunlight.
- Do not format memory cards in a computer.



---

### ✔ **Before Taking Important Pictures**

Before taking pictures on important occasions (such as at weddings or before taking the camera on a trip), take a test shot to ensure that the camera is functioning normally. Nikon will not be held liable for damages or lost profits that may result from product malfunction.

### ✔ **Life-Long Learning**

As part of Nikon's "Life-Long Learning" commitment to ongoing product support and education, continually-updated information is available on-line at the following sites:

- **For users in the U.S.A.:** <https://www.nikonusa.com/>
- **For users in Canada:** <https://www.nikon.ca/>
- **For users in Mexico:** <https://www.nikon.com.mx/>
- **For users in Latin America:**  
<https://www.nikonamericalatina.com/>
- **For users in Europe:** <https://www.europe-nikon.com/support/>
- **For users in Asia, Oceania, the Middle East, and Africa:**  
<https://www.nikon-asia.com/>

Visit these sites to keep up-to-date with the latest product information, tips, answers to frequently-asked questions (FAQs), and general advice on digital imaging and photography. Additional information may be available from the Nikon representative in your area. See the following URL for contact information:

<https://imaging.nikon.com/>

---

# Parts of the Camera

## Camera Body

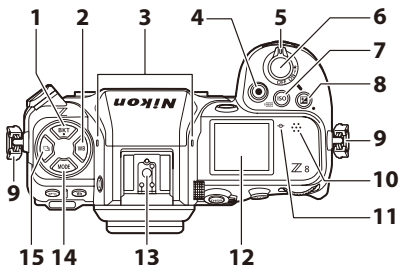

- |   |  |
|---|--|
| <b>1</b> BKT button ( <b>BKT</b> )  | <b>9</b> Eyelet for camera strap                   |
| <b>2</b> WB button ( <b>WB</b> )  | <b>10</b> Speaker                                  |
| <b>3</b> Stereo microphone  | <b>11</b> Focal plane mark ( $\ominus$ )           |
| <b>4</b> Video-record button  | <b>12</b> Control panel                            |
| <b>5</b> Power switch   | <b>13</b> Accessory shoe (for optional flash unit) |
| <b>6</b> Shutter-release button   | <b>14</b> MODE button ( <b>MODE</b> )              |
| <b>7</b> ISO sensitivity button ( <b>ISO</b> )<br>FORMAT button ( <b>FORMAT</b> ) | <b>15</b> Release mode button ( <b>☐</b> )         |
| <b>8</b> Exposure compensation button ( <b>±</b> )                                |  |

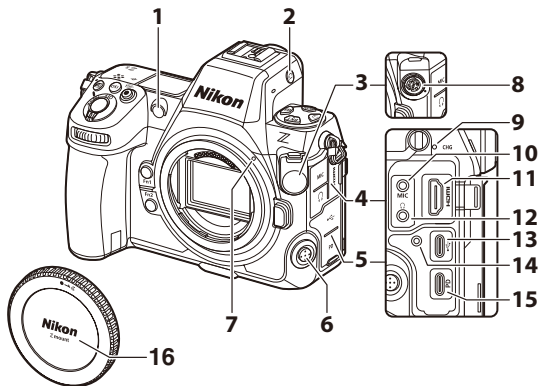

- |  |  |
|--|--|
| <p><b>1</b> AF-assist illuminator<br/>Red-eye reduction lamp<br/>Self-timer lamp</p> <p><b>2</b> Monitor mode button (I/O)</p> <p><b>3</b> Ten-pin remote terminal cover</p> <p><b>4</b> Cover for microphone,<br/>headphone, and HDMI<br/>connectors</p> <p><b>5</b> USB connector cover</p> <p><b>6</b> Focus-mode button</p> <p><b>7</b> Lens mounting mark</p> <p><b>8</b> Ten-pin remote terminal</p> | <p><b>9</b> Charge lamp</p> <p><b>10</b> Connector for external<br/>microphone</p> <p><b>11</b> HDMI connector</p> <p><b>12</b> Headphone connector</p> <p><b>13</b> USB data connector</p> <p><b>14</b> Threaded hole for HDMI/USB<br/>cable clip</p> <p><b>15</b> USB Power Delivery connector</p> <p><b>16</b> Body cap</p> |
|--|--|

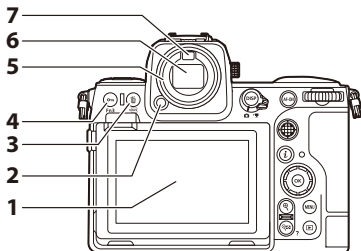

**1** Monitor

**2** Eyepiece release

**3** Delete button (🗑️)

FORMAT button (FORMAT)

**4** Protect button (🔑)

Fn3 button (Fn3)

**5** Rubber eyecup

**6** Viewfinder

**7** Eye sensor

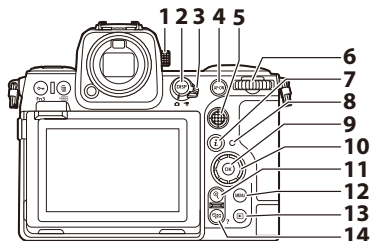

- |                                     |   |
|-------------------------------------|---|
| <b>1</b> Diopter adjustment control | <b>9</b> OK button (OK)                           |
| <b>2</b> DISP button (DISP)         | <b>10</b> Multi selector                          |
| <b>3</b> Photo/video selector       | <b>11</b> Playback zoom in button (⏪)             |
| <b>4</b> AF-ON button (AF-ON)       | <b>12</b> MENU button (MENU)                      |
| <b>5</b> Sub-selector               | <b>13</b> Playback button (▶)                     |
| <b>6</b> Main command dial          | <b>14</b> Playback zoom out/thumbnails button (⏩) |
| <b>7</b> "i" button (i)             | Help button (?)                                   |
| <b>8</b> Memory card access lamp    |   |

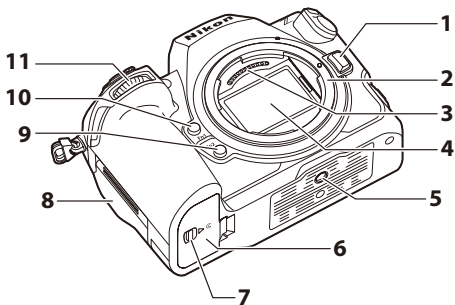

- |                                |                                      |
|--------------------------------|--------------------------------------|
| <b>1</b> Lens release button   | <b>7</b> Battery chamber cover latch |
| <b>2</b> Lens mount            | <b>8</b> Memory card slot cover      |
| <b>3</b> CPU contacts          | <b>9</b> Fn2 button (Fn2)            |
| <b>4</b> Image sensor          | <b>10</b> Fn1 button (Fn1)           |
| <b>5</b> Tripod socket         | <b>11</b> Sub-command dial           |
| <b>6</b> Battery chamber cover |                                      |

# First Steps

## Attaching the Strap

To attach a strap, follow the steps below.

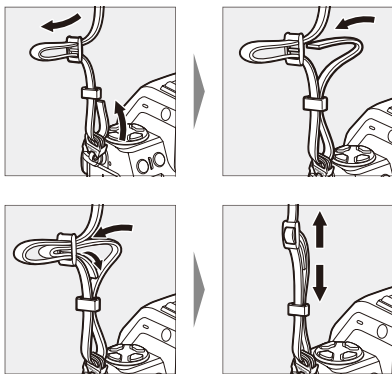

## Charging the Battery

Charge the supplied EN-EL15c battery before use.

### ✔ Caution: The Battery and Charger

Read and follow the warnings and cautions in "For Your Safety" (□8) and "Caring for the Camera and Battery: Cautions" (□49).

## The Battery Charger

Depending on the country or region, the charger comes with either an AC wall adapter or a power cable.

- **AC wall adapter:** After inserting the AC wall adapter into the charger AC inlet (①), slide the AC wall adapter latch as shown (②) and rotate the adapter 90° to fix it in place (③). Insert the battery and plug the charger in.

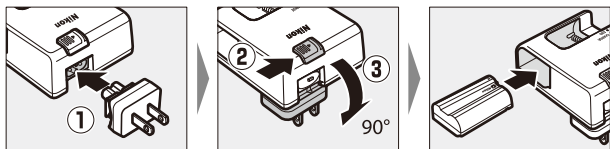

- **Power cable:** After connecting the power cable with the plug in the orientation shown, insert the battery and plug the cable in.

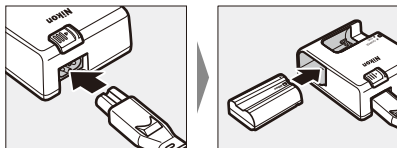



- An exhausted battery will fully charge in about 2 hours and 35 minutes.

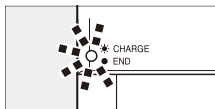

Battery charging  
(flashes)

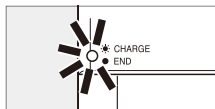

Charging complete  
(steady)

---

### ☑ If the CHARGE Lamp Flashes Rapidly

If the **CHARGE** lamp flashes rapidly (8 times a second):

- **The battery was not inserted correctly:** Unplug the charger and remove and reinsert the battery.
- **The ambient temperature is too hot or too cold:** Use the battery charger at temperatures within the designated temperature range (0–40 °C/+32–104 °F).

If the problem persists, unplug the charger and end charging. Bring the battery and charger to a Nikon-authorized service representative.

---

## **Optional Charging AC Adapters: Charging**

When inserted in the camera, the battery can be charged using an optional EH-7P charging AC adapter.

- An exhausted battery will fully charge in about 2 hours and 40 minutes.
- When charging is complete, unplug the charging AC adapter and disconnect it from the camera.

### **■ Charging**

After confirming that the camera is off, connect the charging AC adapter (①) to the camera's USB Power Delivery connector (②) and plug the adapter in. The battery will charge while the camera is off. Keep the plug straight during insertion and removal.

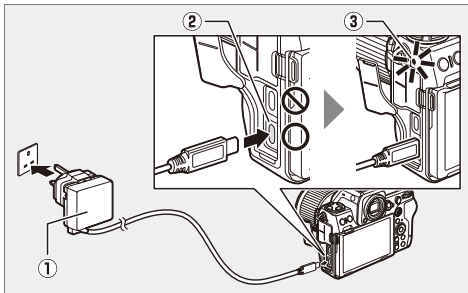

- The camera charge lamp (③) lights amber while charging is in progress. The lamp turns off when charging is complete.
- The battery will also charge when the camera is on, provided that the standby timer is off.
- The shape of the plug varies with the country or region of purchase.

---

**✔ Cautions: The Charging AC Adapter**

- The battery will not charge if the charging AC adapter is connected to the camera's USB data connector.
  - The charging AC adapter can be used only with EN-EL15c and EN-EL15b batteries. EN-EL15a batteries can be charged using an MH-25a battery charger.
  - Charging errors caused by, for example, elevated camera temperatures or attempts to charge an EN-EL15a are indicated by the charge lamp flashing rapidly for about 30 seconds before turning off.
  - After the charge lamp turns off, we recommend that you turn the camera on (or activate the standby timer) and confirm that the battery is charged.
- 

**Tip: The Charging AC Adapter: Power Delivery**

If **[ON]** is selected for **[USB power delivery]** in the setup menu, the charging AC adapter will supply power to the camera when the camera is on.

- Connect the charging AC adapter to the camera's USB Power Delivery connector. The adapter will not supply power to the camera when connected via the USB data connector.
- Power will only be supplied to the camera when the battery is inserted.
- The battery will not charge while the camera is powered by an outside power source.

**Tip: Computer USB Power Delivery and Battery Charging**

Computers will supply current to power the camera or charge the battery only via an optional UC-E25 USB cable (which has Type C connectors at both ends) connected to a built-in Type C USB port on the computer.

- The supplied UC-E24 USB cable (which connects to the camera via a Type C connector and to USB devices via a Type A connector) cannot be used for this purpose.
  - Connect the USB cable to the camera's USB Power Delivery connector. The computer will not supply power to the camera when connected via the USB data connector.
  - Depending on the model and product specifications, some computers will not supply current to power the camera or charge the battery.
-

## Inserting the Battery

- Turn the camera off before inserting or removing the battery.
- Using the battery to keep the orange battery latch pressed to one side, slide the battery into the battery chamber until the latch locks it in place.

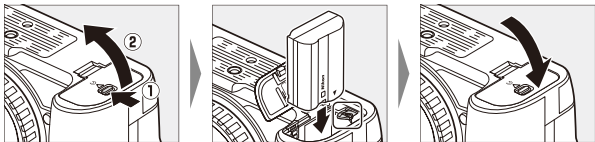

## Removing the Battery

To remove the battery, turn the camera off and open the battery chamber cover. Press the battery latch in the direction shown by the arrow to release the battery and then remove the battery by hand.

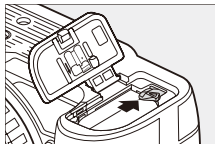

## Battery Level

- The battery level is shown in the shooting display and control panel while the camera is on.







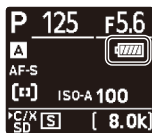

Monitor



Viewfinder



Control panel

- The battery level display changes as the battery level diminishes, from  through , , , and . When the battery level falls to , suspend shooting and charge the battery or ready a spare battery.
- If the message [**Shutter release disabled. Recharge battery.**] is displayed, charge or exchange the battery.

---

### The Standby Timer

The camera uses a standby timer to help reduce the drain on the battery. If no operations are performed for about 30 seconds, the standby timer will expire and the monitor, viewfinder, and control panel will turn off. A few seconds prior to turning off, the monitor and viewfinder will dim. They can be reactivated by pressing the shutter-release button halfway. The length of time before the standby timer expires automatically can be selected using Custom Setting c3 [**Power off delay**] > [**Standby timer**].

---

## Inserting Memory Cards

The camera is equipped with two memory card slots: a slot that takes one CFexpress or XQD memory card (①) and another that takes one SD memory card (②), for a total of two cards, one of each type.

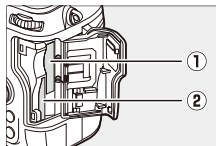

- Turn the camera off before inserting or removing memory cards.
- Holding the memory card in the orientation shown, slide it straight into the slot until it clicks into place.
  - **CFexpress and XQD memory cards:**

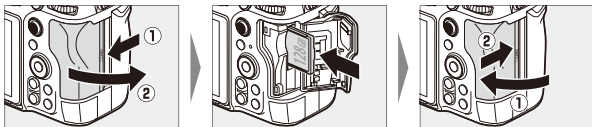

- **SD memory cards:**

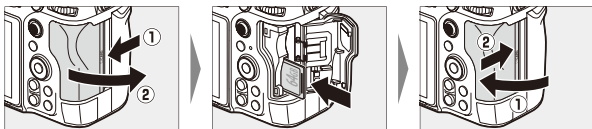

- If this is the first time the card will be used in the camera, format it using [**Format memory card**] in the setup menu.

### Tip: Number of Exposures Remaining

- The shooting display and control panel show the number of photographs that can be taken at current settings.
- Values over 1000 are rounded down to the nearest hundred. For example, values between 8000 and 8099 are shown as 8.0 k.
- If no memory cards are inserted, an [-E-] indicator will be displayed.



### Tip: The Write Protect Switch

- SD memory cards are equipped with a write-protect switch. Sliding the switch to the “lock” position write-protects the card, protecting the data it contains.

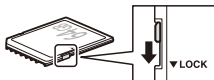

- A “---” indicator and a [Card] warning appear in the shooting display when a write-protected card is inserted.
- If you attempt to release the shutter while a write-protected card is inserted, a warning will be displayed and no picture will be recorded. Unlock the memory card before attempting to take or delete pictures.

### Tip: Slot Icons

The location of the current picture is shown by an icon at the bottom left corner of the playback display.

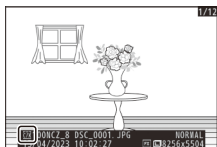



## Removing Memory Cards

After confirming that the memory card access lamp is off, turn the camera off, open the memory card slot cover, and press the card in to eject it (①). The card can then be removed by hand (②).

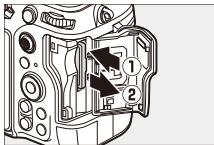

### Memory Card High-Temperature Warning

As indicated in the label inside the memory card slot cover, memory cards may become hot while inserted in the camera. Wait for any high-temperature warnings to clear from the shooting display before handling the camera and memory cards.

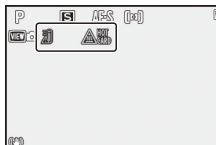
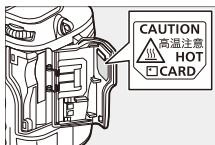

## Attaching a Lens

- The camera can be used with Z mount lenses. For more information on lenses, see the lens documentation available from the Nikon Download Center.
- The lens generally used in this document for illustrative purposes is a NIKKOR Z 50mm f/1.8 S.
- Be careful to prevent dust entering the camera.
- Confirm that the camera is off before attaching the lens.
  - Remove the camera body cap (①, ②) and rear lens cap (③, ④).

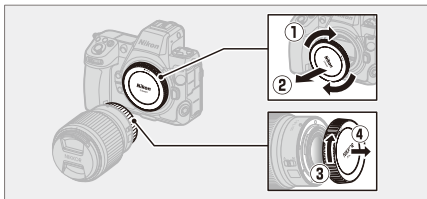

- Align the mounting marks on the camera (⑤) and lens (⑥). Do not touch the image sensor or lens contacts.

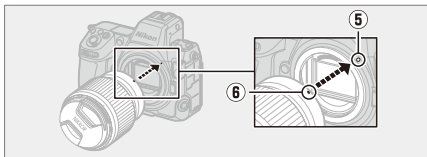

- Rotate the lens as shown until it clicks into place (7).



- Remove the front lens cap before taking pictures.

---

### **✓ F Mount Lenses**

- Be sure to attach an FTZ II or FTZ mount adapter (available separately) to the camera before using F mount lenses.
  - Attempting to attach F mount lenses directly to the camera could damage the lens or image sensor.
- 

### **Detaching Lenses**

- After turning the camera off, press and hold the lens release button (1) while turning the lens in the direction shown (2).
- After removing the lens, reattach the lens caps and camera body cap.

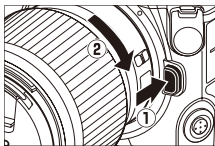



# Camera Setup

Turn the camera on, choose a language, and set the clock. Before using the camera for the first time, follow the steps below to choose a language and time zone and set the clock so that the correct time and date will be recorded with any pictures you take.

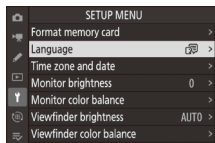
- 1 Press MENU, and in the setup menu highlight [Language] and press .**



- 2 Select a language.**

Press  or  to highlight the desired language and press  (the languages available vary with the country or region in which the camera was originally purchased).

- 3 Highlight [Time zone and date] and press .**

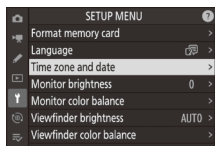

## 4 Choose a time zone.

- Select **[Time zone]** in the **[Time zone and date]** display.
- The display lists selected cities in the chosen zone and the difference between the time in the chosen zone and UTC.
- Highlight a time zone in the **[Time zone]** display and press **OK**.

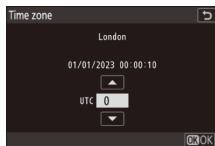

## 5 Turn daylight saving time on or off.

- Select **[Daylight saving time]** in the **[Time zone and date]** display.
- Select **[ON]** (daylight saving time on) or **[OFF]** (daylight saving time off).
- Selecting **[ON]** advances the clock one hour; to undo the effect, select **[OFF]**.

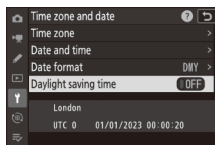

## 6 Set the clock.

- Select **[Date and time]** in the **[Time zone and date]** display.
- Press **OK** after using the multi selector to set the clock to the date and time in the selected time zone in the **[Date and time]** display (note that the camera uses a 24-hour clock).

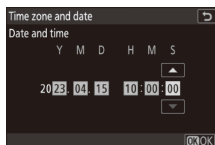

## 7 Choose a date format.

- Select **[Date format]** in the **[Time zone and date]** display.
- Highlight the desired date (year, month, and day) display order and press **OK**.

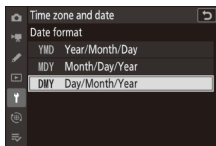

## 8 Exit the menus.

Lightly press the shutter-release button halfway to exit to shooting mode.



---

### ☑ The ☺ Icon

A flashing ☺ icon in the shooting display indicates that the camera clock has been reset. The date and time recorded with new photographs will not be correct; use the **[Time zone and date]** > **[Date and time]** option in the setup menu to set the clock to the correct time and date. The camera clock is powered by an independent clock battery. The clock battery charges when the main battery is inserted in the camera. It takes about 2 days to charge. Once charged, it will power the clock for about a month.

---

# Basic Photography and Playback

## Taking Photographs

The basic steps involved in taking photographs are described below.

### ✔ Lenses with Retractable Barrels

Lenses with retractable barrels must be extended before use. Rotate the zoom ring as shown until the lens clicks into place in the extended position.

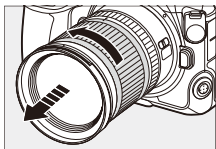

- 1** Select photo mode by rotating the photo/video selector to .

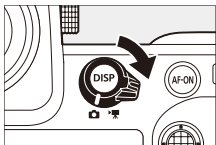

## 2 Ready the camera.

Holding the handgrip in your right hand and cradling the camera body or lens with your left, bring your elbows in against the sides of your chest.



Landscape (wide)  
orientation



Portrait (tall)  
orientation

## 3 Frame the photograph.

Position the main subject near the center of the frame.

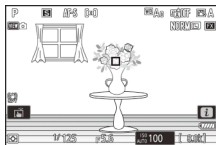



**4 To focus, press the shutter-release button halfway (i.e., lightly press the shutter-release button, stopping when it is pressed halfway).**

- The focus point will be displayed in green when the subject is in focus. If the camera is unable to focus, the focus point will flash red.
- The AF-assist illuminator may light to assist the focus operation if the subject is poorly lit.
- You can also focus by pressing the **AF-ON** button.

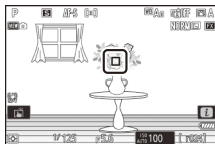

---

**☑ The AF-Assist Illuminator**

Do not obstruct the AF-assist illuminator while it is lit.

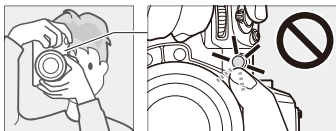

- 5** Without lifting your finger from the shutter-release button, press the button the rest of the way down to take the picture.



---

**✔ The Memory Card Access Lamp**

The memory card access lamp will light while the photograph is being recorded. *Do not remove the memory card or battery.*

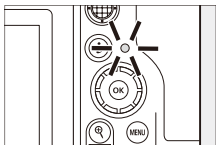

---

**Tip: The Touch Shutter**

You can also take a photograph by touching the monitor. Touch your subject to focus and lift your finger to release the shutter.

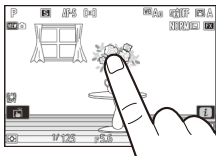

# Recording Videos

The basic steps involved in recording videos are described below.

## 1 Select video mode by rotating the photo/video selector to .

Note that optional flash units cannot be used when the camera is in video mode.

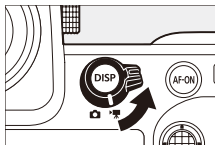

## 2 Press the video-record button to start recording.

- A recording indicator will be displayed and the borders of the shooting display will turn red. The display also shows the time remaining, or in other words the approximate amount of new footage that can be recorded to the memory card.

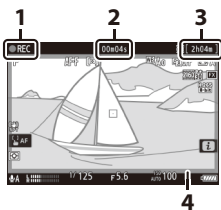
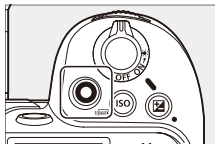

- 1 Recording indicator
- 2 Video recording time (length of footage recorded)
- 3 Available recording time
- 4 Recording indicator (red border)

- The camera can be refocused during recording by pressing the **AF-ON** button.
- Sound is recorded via the built-in microphone. Do not cover the microphone during recording.
- You can also focus by tapping your subject in the monitor.

### 3 Press the video-record button again to end recording.

---

#### ✔ The Memory Card Access Lamp

The memory card access lamp will light while the video is being recorded. *Do not remove the memory card or battery.*

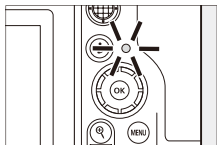

#### ✔ The Icon

A  icon indicates that videos cannot be recorded.

### ✔ Cautions: Recording Videos

- Video recording will end automatically if:
  - the maximum length is reached,
  - the battery is exhausted,
  - you choose a different shooting mode,
  - you switch modes using the photo/video selector,
  - the lens is removed, or
  - the camera's internal temperature rises.
- Sounds made by the camera may be audible in footage recorded:
  - during autofocus,
  - during vibration reduction, or
  - when power aperture is used.

### ✔ High-Temperature Warnings

During video recording, the camera or memory cards may become hot and a high-temperature warning or memory card high-temperature warning may appear in the shooting display. Wait for the camera to cool and the warnings to clear from the display before handling the camera, battery, or memory cards.



---



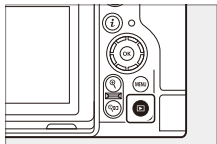

## Playback

Press the  button to view photos and videos in the monitor or viewfinder after shooting.

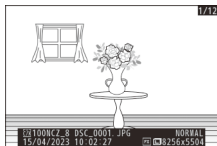

- Press  or  or flick left or right to view additional pictures.



- Videos are indicated by a  icon at the top left corner of the display. Tap the  icon in the display or press the  button to start playback.

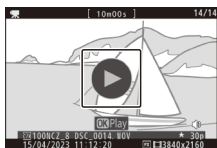

- To end playback and return to shooting mode, press the shutter-release button halfway.

# Troubleshooting

## Before Contacting Customer Support

You may be able to resolve any issues with the camera by following the steps below. Check this list before consulting your retailer or Nikon-authorized service representative.

### **1 Check the list of common problems.**

Common problems and solutions are listed in the troubleshooting section of the *Reference Guide*.

### **2 Turn the camera off and remove the battery, then wait about a minute, re-insert the battery and turn the camera on.**

☑ The camera may continue to write data to the memory card after shooting. Wait at least a minute before removing the battery.

### **3 Search Nikon websites.**

- For support information and answers to frequently asked questions, visit the website for your country or region (□17).
- To download the latest firmware for your camera, visit: <https://downloadcenter.nikonimglib.com/>

### **4 Consult a Nikon-authorized service representative.**

# Technical Notes

## Caring for the Camera

### Long-Term Storage

Remove the battery if the product will not be used for an extended period. Before removing the battery, confirm that the camera is off.

Do not store the camera in locations that:

- are poorly ventilated or subject to humidities of over 60%,
- are next to equipment that produces strong electromagnetic fields, such as televisions or radios, or
- are exposed to temperatures above 50 °C (122 °F) or below –20 °C (–4 °F).



## Cautions: Using the Camera

### ● **Do Not Drop**

Do not drop the camera or lens or subject them to blows. The product may malfunction if subjected to strong shocks or vibration.

### ● **Keep Dry**

Keep the camera dry. Rusting of the internal mechanism caused by water inside the camera can not only be expensive to repair but can in fact cause irreparable damage.

### ● **Avoid Sudden Changes in Temperature**

Taking the camera from a warm to a cold environment or *vice versa* may cause damaging condensation inside and outside the camera. Place the camera in a sealed bag or plastic case before taking it across a temperature boundary. The camera can be taken from the bag or case once it has had time to adjust to the new temperature.

### ● **Keep Away from Strong Magnetic Fields**

Static charges or the magnetic fields produced by equipment such as radio transmitters could interfere with the monitor, corrupt data stored on the memory card, or affect the product's internal circuitry.

### ● **Keep Credit Cards and Other Such Magnetic Storage Devices Away from the Camera and Lens**

Data stored on the device could be corrupted.

### ● **Do Not Leave the Lens Pointed at the Sun**

Do not leave the lens pointed at the sun or other bright light source. Intense light may damage the image sensor or cause fading or "burn in". Photographs taken with the camera may exhibit a white blur effect.

### ● Lasers and Other Bright Light Sources

Do not direct lasers or other extremely bright light sources toward the lens, as this could damage the camera's image sensor.

### ● Cleaning

When cleaning the camera body, use a blower to gently remove dust and lint, then wipe gently with a soft, dry cloth. After using the camera at the beach or seaside, wipe off any sand or salt using a cloth lightly dampened in fresh water and then dry the camera thoroughly. In rare instances, static electricity may cause the LCD displays to light up or go dark; this does not indicate a malfunction. The display will soon return to normal.

### ● Cleaning the Lens and Viewfinder

These glass elements are easily damaged: remove dust and lint with a blower. If using an aerosol blower, keep the can vertical to prevent the discharge of liquid that could damage glass elements. To remove fingerprints and other stains from the lens, apply a small amount of lens cleaner to a soft cloth and wipe the lens carefully.

### ● Do Not Touch the Image Sensor

Under no circumstances should you exert pressure on the image sensor, poke it with cleaning tools, or subject it to powerful air currents from a blower. These actions could scratch or otherwise damage the sensor.

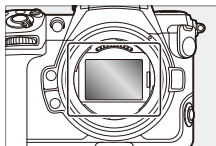

### ● Do Not Touch the Sensor Shield

If [**Sensor shield closes**] is selected for [**Sensor shield behavior at power off**] in the setup menu, the sensor shield in front of the image sensor will close when the camera turns off. Never pierce or apply pressure to the sensor shield. Failure to observe this precaution could scratch or otherwise damage the shield.

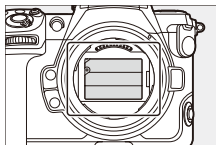

### ● The Lens Contacts

Keep the lens contacts clean. Avoid touching them with your fingers.

### ● Store in a Well-Ventilated Area

To prevent mold or mildew, store the camera in a dry, well-ventilated area. Do not store the camera with naphtha or camphor moth balls, next to equipment that produces strong electromagnetic fields, or where it will be exposed to extremely high temperatures, for example near a heater or in an enclosed vehicle on a hot day. Failure to observe these precautions could result in product malfunction.

### ● Long-Term Storage

To prevent damage caused for example by leaking battery fluid, remove the battery if the product will not be used for an extended period. Store the camera in a plastic bag containing a desiccant. Do not, however, store the leather camera case in a plastic bag, as this may cause the material to deteriorate. Store the battery in a cool, dry place. Note that desiccant gradually loses its capacity to absorb moisture and should be replaced at regular intervals. To prevent mold or mildew, take the camera out of storage at least once a month, insert the battery, and release the shutter a few times.

## ● **Turn the Product Off Before Removing or Disconnecting the Power Source**

Removing or disconnecting the power source while the camera is on could damage the product. Particular care should be taken not to remove or disconnect the power source while pictures are being recorded or deleted.

## ● **Monitor/Viewfinder**

- The monitor and viewfinder are constructed with extremely high precision; at least 99.99% of pixels are effective, with no more than 0.01% being missing or defective. Hence while these displays may contain pixels that are always lit (white, red, blue, or green) or always off (black), this is not a malfunction. Pictures recorded with the device are unaffected. Your understanding is requested.
- Pictures in the monitor may be difficult to see in a bright light.
- Do not apply pressure to the monitor. It could malfunction or suffer damage. Dust or lint can be removed with a blower. Stains can be removed by wiping the monitor lightly with a soft cloth or chamois leather. Should the monitor break, care should be taken to avoid injury from broken glass. Be careful that liquid crystal from the monitor does not touch the skin or enter the eyes or mouth.
- Should you experience any of the following symptoms while framing shots in the viewfinder, discontinue use until your condition improves:
  - nausea, eye pain, eye fatigue,
  - dizziness, headache, stiffness in your neck or shoulders,
  - queasiness or loss of hand-eye coordination, or
  - motion sickness.
- The display may rapidly flicker on and off during burst photography. Watching the flickering display could cause you to feel unwell. Discontinue use until your condition improves.

### ● **Bright Lights and Back-Lit Subjects**

Noise in the form of lines may in rare cases appear in pictures that include bright lights or back-lit subjects.

### ● **Camera Shooting and Playback Displays**

When [HLG] is selected for tone mode, the shooting and playback displays in the camera monitor and viewfinder may include “noise” in the form of randomly-spaced bright pixels, fog, or lines or may fail to accurately reproduce highlights and highly-saturated colors. In addition, abrupt tone discontinuities may be visible in the camera monitor or viewfinder when photos are displayed full-frame, although the photos themselves are unaffected. For accurate tone reproduction, use monitors, computers, operating systems, applications, and other equipment compatible with HLG.

---

### ✔ **Cautions: Disposing of Data Storage Devices**

Please note that deleting pictures or formatting memory cards or other data storage devices does not completely erase the original image data. Deleted files can sometimes be recovered from discarded storage devices using commercially available software, potentially resulting in the malicious use of personal image data. Ensuring the privacy of such data is the user’s responsibility.

Before discarding a data storage device or transferring ownership to another person, erase all data using commercial deletion software, or format the device and then completely refill it with pictures containing no private information (for example, pictures of empty sky). Care should be taken to avoid injury when physically destroying data storage devices.

Before discarding the camera or transferring ownership to another person, you should also use the [**Reset all settings**] item in the camera setup menu to delete network settings and other personal information.

---

## **Cautions: Using Batteries**

### **● Precautions for Use**

- If improperly handled, batteries may rupture or leak, causing the product to corrode. Observe the following precautions when handling batteries:
  - Turn the product off before replacing the battery.
  - Batteries may be hot after extended use.
  - Keep the battery terminals clean.
  - Use only batteries approved for use in this equipment.
  - Do not short or disassemble batteries or expose them to flame or excessive heat.
  - Replace the terminal cover when the battery is not inserted in the camera or charger.
- If the battery is hot, for example immediately after use, wait for it to cool before charging. Attempting to charge the battery while its internal temperature is elevated will impair battery performance, and the battery may not charge or charge only partially.
- If the battery will not be used for some time, remove it from the camera and store it in a cool, dry location with an ambient temperature of 15 °C to 25 °C (59 °F to 77 °F). Avoid hot or extremely cold locations.
- Batteries in long-term storage should be charged to about 50% at least once a year. Do not charge the battery to 100% before returning it to storage. A fully-exhausted battery will charge to around 50% in about half the time needed to charge it to 100%.

- Remove the battery from the camera or charger when not in use. The camera and charger draw minute amounts of charge even when off and could draw the battery down to the point that it will no longer function.
- Do not use the battery at ambient temperatures below  $-10^{\circ}\text{C}$  ( $14^{\circ}\text{F}$ ) or above  $40^{\circ}\text{C}$  ( $104^{\circ}\text{F}$ ). Failure to observe this precaution could damage the battery or impair its performance. Charge the battery indoors at ambient temperatures of  $5^{\circ}\text{C}$ – $35^{\circ}\text{C}$  ( $41^{\circ}\text{F}$ – $95^{\circ}\text{F}$ ). The battery will not charge if its temperature is below  $0^{\circ}\text{C}$  ( $32^{\circ}\text{F}$ ) or above  $60^{\circ}\text{C}$  ( $140^{\circ}\text{F}$ ).
- Capacity may be reduced and charging times increase at battery temperatures from  $0^{\circ}\text{C}$  ( $32^{\circ}\text{F}$ ) to  $15^{\circ}\text{C}$  ( $59^{\circ}\text{F}$ ) and from  $45^{\circ}\text{C}$  ( $113^{\circ}\text{F}$ ) to  $60^{\circ}\text{C}$  ( $140^{\circ}\text{F}$ ).
- Batteries in general exhibit a drop in capacity at low ambient temperatures. Even fresh batteries charged at temperatures under about  $5^{\circ}\text{C}$  ( $41^{\circ}\text{F}$ ) may show a temporary increase from "0" to "1" in the setup menu [**Battery info**] age display, but the display will return to normal once the battery has been recharged at a temperature of about  $20^{\circ}\text{C}$  ( $68^{\circ}\text{F}$ ) or higher.
- Battery capacity drops at low temperatures. The change in capacity with temperature is reflected in the camera battery-level display. As a result, the battery display may show a drop in capacity as the temperature drops, even if the battery is fully charged.
- Batteries may be hot after use. Observe due caution when removing batteries from the camera.

### ● **Charge Batteries Before Use**

Charge the battery before use. The supplied battery is not fully charged at shipment.

### ● **Ready Spare Batteries**

Before taking photographs, ready a spare battery and keep it fully charged. Depending on your location, it may be difficult to purchase replacement batteries on short notice.

### ● **Have Fully-Charged Spare Batteries Ready on Cold Days**

Partially-charged batteries may not function on cold days. In cold weather, charge one battery before use and keep another in a warm place, ready to be exchanged as necessary. Once warmed, cold batteries may recover some of their charge.

### ● **Battery Level**

- Turning the camera on or off repeatedly when the battery is fully discharged will shorten battery life. Batteries that have been fully discharged must be charged before use.
- A marked drop in the time a fully charged battery retains its charge when used at room temperature indicates that it requires replacement. Purchase a new rechargeable battery.

### ● **Do Not Attempt to Charge Fully-Charged Batteries**

Continuing to charge the battery after it is fully charged can impair battery performance.

### ● **Recycling Used Batteries**

Recycle rechargeable batteries in accord with local regulations, being sure to first insulate the terminals with tape.



## **Cautions: Using the Charger**

- Do not move the charger or touch the battery during charging; failure to observe this precaution could in very rare instances result in the charger showing that charging is complete when the battery is only partially charged. Remove and reinsert the battery to begin charging again.
- Do not short the charger terminals. Failure to observe this precaution could result in overheating and damage to the charger.
- Unplug the charger when it is not in use.
- Use the MH-25a with compatible batteries only.
- Do not use chargers with damage that leaves the interior exposed or that produce unusual sounds when used.
- The symbols on this product represent the following:  
~ AC, --- DC,  Class II equipment (the construction of the product is double-insulated)

## Trademarks and Licenses

- CFexpress is a trademark of the CompactFlash Association in the United States and other countries.
- NVM Express is a trademark or registered trademark of NVM Express Inc.
- XQD is a trademark of Sony Corporation.
- The SD, SDHC, and SDXC logos are trademarks of SD-3C, LLC.
- Windows is either a registered trademark or a trademark of Microsoft Corporation in the United States and/or other countries.
- Apple®, App Store®, the Apple logos, iPhone®, iPad®, Mac, and macOS are trademarks of Apple Inc. registered in the U.S. and/or other countries.
- Android, Google Play and the Google Play logo are trademarks of Google LLC. The Android robot is reproduced or modified from work created and shared by Google and used according to terms described in the Creative Commons 3.0 Attribution License.
- IOS is a trademark or registered trademark of Cisco Systems, Inc., in the United States and/or other countries and is used under license.
- HDMI, the HDMI logo and High-Definition Multimedia Interface are trademarks or registered trademarks of HDMI Licensing, LLC.

**HDMI**

- The Bluetooth® word mark and logo are registered trademarks owned by Bluetooth SIG, Inc., and any use of such marks by Nikon is under license.
- Wi-Fi and the Wi-Fi logo are trademarks or registered trademarks of the Wi-Fi Alliance.
- Powered by intoPIX technology.



- All other trade names mentioned in this document or the other documentation provided with your Nikon product are trademarks or registered trademarks of their respective holders.
- Use of the Made for Apple badge means that an accessory has been designed to connect specifically to the Apple products identified in the badge, and has been certified by the developer to meet Apple performance standards. Apple is not responsible for the operation of this device or its compliance with safety and regulatory standards. Please note that the use of this accessory with an Apple product may affect wireless performance.
- This product includes software developed by the OpenSSL Project for use in the OpenSSL Toolkit.
- The software for this product includes open-source software copyrighted by third parties. The terms of the licenses for this open-source software may be found in the *Reference Guide*.  
<https://downloadcenter.nikonimglib.com/>

## Notices

### ● Notices for Customers in the U.S.A.

#### The Battery Charger

### **IMPORTANT SAFETY INSTRUCTIONS—SAVE THESE INSTRUCTIONS**

### **DANGER—TO REDUCE THE RISK OF FIRE OR ELECTRIC SHOCK, CAREFULLY FOLLOW THESE INSTRUCTIONS**

For connection to a supply not in the U.S.A., use an attachment plug adapter of the proper configuration for the power outlet if needed.

This power unit is intended to be correctly oriented in a vertical or floor mount position.

### **Federal Communications Commission (FCC) Radio Frequency Interference Statement**

This equipment has been tested and found to comply with the limits for a Class B digital device, pursuant to Part 15 of the FCC rules.

These limits are designed to provide reasonable protection against harmful interference in a residential installation. This equipment generates, uses, and can radiate radio frequency energy and, if not installed and used in accordance with the instructions, may cause harmful interference to radio communications. However, there is no guarantee that interference will not occur in a particular installation. If this equipment does cause harmful interference to radio or television reception, which can be determined by turning the equipment off and on, the user is encouraged to try to correct the interference by one or more of the following measures:

- Reorient or relocate the receiving antenna.
- Increase the separation between the equipment and receiver.
- Connect the equipment into an outlet on a circuit different from that to which the receiver is connected.
- Consult the dealer or an experienced radio/television technician for help.

## CAUTIONS

### *Modifications*

The FCC requires the user to be notified that any changes or modifications made to this device that are not expressly approved by Nikon Corporation may void the user's authority to operate the equipment.



**Nikon**  
Z 8

### *Interface Cables*

Use the interface cables sold or provided by Nikon for your equipment. Using other interface cables may exceed the limits of Class B Part 15 of the FCC rules.

Nikon Inc., 1300 Walt Whitman Road, Melville, New York 11747-3064, U.S.A.

Tel.: 631-547-4200

### ● **Power Cable**

At voltages over AC 125 V (U.S.A. only): The power cable must be rated for the voltage in use, be at least AWG no. 18 gauge, and have SVG insulation or better with a NEMA 6P-15 plug rated for AC 250 V 15 A.

### ● **Notice for Customers in Canada**

CAN ICES-003(B) / NMB-003(B)

## ● Notices for Customers in Europe

**CAUTION:** RISK OF EXPLOSION IF BATTERY IS REPLACED BY AN INCORRECT TYPE. DISPOSE OF USED BATTERIES ACCORDING TO THE INSTRUCTIONS.

This symbol indicates that electrical and electronic equipment is to be collected separately. The following apply only to users in European countries:

- This product is designated for separate collection at an appropriate collection point. Do not dispose of as household waste.
- Separate collection and recycling helps conserve natural resources and prevent negative consequences for human health and the environment that might result from incorrect disposal.
- For more information, contact the retailer or the local authorities in charge of waste management.



This symbol on the battery indicates that the battery is to be collected separately. The following apply only to users in European countries:

- All batteries, whether marked with this symbol or not, are designated for separate collection at an appropriate collection point. Do not dispose of as household waste.
- For more information, contact the retailer or the local authorities in charge of waste management.



## Bluetooth and Wi-Fi (Wireless LAN)

This product is controlled by the United States Export Administration Regulations (EAR). The permission of the United States government is not required for export to countries other than the following, which as of this writing are subject to embargo or special controls: Cuba, Iran, North Korea, Sudan, and Syria (list subject to change).

The use of wireless devices may be prohibited in some countries or regions. Familiarize yourself with and obey all applicable local regulations.

The Bluetooth transmitter in this device operates in the 2.4 GHz band.

### ● **Notice for Customers in the U.S.A. and Canada**

This device complies with part 15 of FCC Rules and Innovation, Science and Economic Development Canada's licence-exempt RSSs. Operation is subject to the following two conditions: (1) this device may not cause harmful interference, and (2) this device must accept any interference received, including interference that may cause undesired operation.

### **FCC WARNING**

The FCC requires the user to be notified that any changes or modifications made to this device that are not expressly approved by Nikon Corporation may void the user's authority to operate the equipment.

### **Compliance with FCC requirement 15.407(c)**

Data transmission is always initiated by software, which is then passed down through the MAC, through the digital and analog baseband, and finally to the RF chip. Several special packets are initiated by the MAC. These are the only ways the digital baseband portion will turn on the RF transmitter, which it then turns off at the end of the packet. Therefore, the transmitter will be on only while one of the aforementioned packets is being transmitted. In other words, this device automatically discontinues transmission in case of either absence of information to transmit or operational failure.

Frequency Tolerance:  $\pm 20$  ppm

### **FCC Radio Frequency Interference Statement**

Note: This equipment has been tested and found to comply with the limits for a Class B digital device, pursuant to part 15 of the FCC Rules. These limits are designed to provide reasonable protection against harmful interference in a residential installation. This equipment generates, uses and can radiate radio frequency energy and, if not installed and used in accordance with the instructions, may cause harmful interference to radio communications. However, there is no guarantee that interference will not occur in a particular installation. If this equipment does cause harmful interference to radio or television reception, which can be determined by turning the equipment off and on, the user is encouraged to try to correct the interference by one or more of the following measures:

- Reorient or relocate the receiving antenna.
- Increase the separation between the equipment and receiver.
- Connect the equipment into an outlet on a circuit different from that to which the receiver is connected.
- Consult the dealer or an experienced radio/TV technician for help.



**Co-location**

This transmitter must not be co-located or operated in conjunction with any other antenna or transmitter.

Nikon Inc., 1300 Walt Whitman Road, Melville, New York 11747-3064, U.S.A.

Tel.: 631-547-4200

**FCC/ISED RF Exposure Statement**

The available scientific evidence does not show that any health problems are associated with using low power wireless devices. There is no proof, however, that these low power wireless devices are absolutely safe. Low power Wireless devices emit low levels of radio frequency energy (RF) in the microwave range while being used. Whereas high levels of RF can produce health effects (by heating tissue), exposure of low-level RF that does not produce heating effects causes no known adverse health effects. Many studies of low-level RF exposures have not found any biological effects. Some studies have suggested that some biological effects might occur, but such findings have not been confirmed by additional research. This product has been tested and found to comply with FCC/ISED radiation exposure limits set forth for an uncontrolled environment and meets the FCC radio frequency (RF) Exposure Guidelines and RSS-102 of the ISED radio frequency (RF) Exposure rules. Please refer to the SAR test report that was uploaded to FCC website.

## **Compliance with RSS-247 Issue 2 §6.4**

Data transmission is always initiated by software, which is then passed down through the MAC, through the digital and analog baseband, and finally to the RF chip. Several special packets are initiated by the MAC. These are the only ways the digital baseband portion will turn on the RF transmitter, which it then turns off at the end of the packet. Therefore, the transmitter will be on only while one of the aforementioned packets is being transmitted. In other words, this device automatically discontinues transmission in case of either absence of information to transmit or operational failure.

### **● Notice for Customers in Canada**

For indoor use only (5150–5250 MHz).

### **● Notice for Customers in Europe and in Countries Complying with the Radio Equipment Directive**

Hereby, Nikon Corporation declares that the radio equipment type Z 8 is in compliance with Directive 2014/53/EU.



The full text of the EU declaration of conformity is available at the following internet address:

[https://imaging.nikon.com/support/pdf/DoC\\_N2120.pdf](https://imaging.nikon.com/support/pdf/DoC_N2120.pdf)

For this radio equipment, 5150–5350 MHz band is restricted to indoor operations only. This restriction on putting into service or of the requirement for authorization of use applies in AT, BE, BG, CY, CZ, DK, EE, FI, FR, DE, EL, MK, IE, IT, LV, LT, LU, MT, NL, PL, PT, RO, SK, LI, HU, SI, ES, SE, UK (NI), IS, ME, NO, CH, TR, HR and RS.

## Wi-Fi

- Operating frequency:
  - Europe (excluding the countries listed below), Israel, and Turkey: 2412–2472 MHz (channel 13) and 5180–5825 MHz (5180–5700 MHz and 5745–5825 MHz)
  - Russia, Belarus, Kazakhstan, and Ukraine: 2412–2462 MHz (channel 11) and 5180–5320 MHz
  - Australia, New Zealand, and the Republic of Fiji: 2412–2462 MHz (channel 11) and 5180–5825 MHz (5180–5580 MHz, 5660–5700 MHz, and 5745–5825 MHz)
  - U.S.A., Canada, and Mexico: 2412–2462 MHz (channel 11) and 5180–5825 MHz (5180–5240 MHz, 5500–5580 MHz, 5660–5700 MHz, and 5745–5825 MHz)
  - Other countries in the Americas: 2412–2462 MHz (channel 11) and 5180–5805 MHz (5180–5240 MHz and 5745–5805 MHz)
  - Asia (other than Turkey, Kazakhstan, Taiwan, Bangladesh, Pakistan, and India), and New Caledonia: 2412–2462 MHz (channel 11) and 5745–5805 MHz
  - India: 2412–2472 MHz (channel 13) and 5180–5825 MHz (5180–5320 MHz and 5745–5825 MHz)
  - Africa, the Middle East (other than Israel), Taiwan, Bangladesh, Pakistan, and Bolivia: 2412–2462 MHz (channel 11)
- Maximum output power (EIRP):
  - 2.4 GHz band: 1.4 dBm
  - 5 GHz band (5180–5320 MHz): 10.8 dBm
  - 5 GHz band (5500–5825 MHz): 7.8 dBm

## Bluetooth

- Operating frequency:
  - Bluetooth: 2402–2480 MHz
  - Bluetooth Low Energy: 2402–2480 MHz
- Maximum output power (EIRP):
  - Bluetooth: –4.1 dBm
  - Bluetooth Low Energy: –5.6 dBm

## ● Notice for Customers in Europe Standby Power Consumption

Mode	Power consumption
Standby/off mode	Less than 0.5 W
Networked standby mode (Bluetooth connections)	Less than 2 W

## ● Notice for Customers in the UK

Hereby, Nikon Corporation declares that the radio equipment type Z 8 is in compliance with Radio Equipment Regulations 2017.



The full text of the UKCA declaration of conformity is available at the following internet address:

[https://imaging.nikon.com/support/pdf/UKCA\\_DoC\\_N2120.pdf](https://imaging.nikon.com/support/pdf/UKCA_DoC_N2120.pdf)

For this radio equipment, 5150–5350 MHz band is restricted to indoor operations only.

## Wi-Fi

- Operating frequency:
  - 2412–2472 MHz (channel 13) and 5180–5825 MHz (5180–5700 MHz and 5745–5825 MHz)
- Maximum output power (EIRP):
  - 2.4 GHz band: 1.4 dBm
  - 5 GHz band (5180–5320 MHz): 10.8 dBm
  - 5 GHz band (5500–5825 MHz): 7.8 dBm

## Bluetooth

- Operating frequency:
  - Bluetooth: 2402–2480 MHz
  - Bluetooth Low Energy: 2402–2480 MHz
- Maximum output power (EIRP):
  - Bluetooth: –4.1 dBm
  - Bluetooth Low Energy: –5.6 dBm

## ● Security

Although one of the benefits of this product is that it allows others to freely connect for the wireless exchange of data anywhere within its range, the following may occur if security is not enabled:

- Data theft: Malicious third-parties may intercept wireless transmissions to steal user IDs, passwords, and other personal information.
- Unauthorized access: Unauthorized users may gain access to the network and alter data or perform other malicious actions. Note that due to the design of wireless networks, specialized attacks may allow unauthorized access even when security is enabled.
- Unsecured networks: Connecting to open networks may result in unauthorized access. Use secure networks only.

---

### Tip: Conformity Marking

The standards with which the camera complies can be viewed using the [**Conformity marking**] option in the setup menu.

---

## Z 8 Model Name: N2120



A series of 20 horizontal lines for writing, spaced evenly down the page.

# Warranty Terms - Nikon Europe Service Warranty

Dear Nikon Customer,

We thank you for your purchasing this Nikon product. Should your Nikon product require warranty service, please contact the dealer from whom it was purchased or a member of our authorized service network within the sales territory of Nikon Europe B.V. (e.g. Europe/Russia/ others). See details under:

<https://www.europe-nikon.com/support>

In order to avoid any unnecessary inconvenience, we advise you to read the user manuals carefully before contacting the dealer or our authorized service network.

Your Nikon equipment is guaranteed against any manufacturing defects for one full year from the date of original purchase. If during this period of guarantee the product proves defective due to improper material or workmanship, our authorized service network within the sales territory of Nikon Europe B.V. will, without charge for labor and parts, repair the product in the terms and conditions set as below. Nikon reserves the right (at its sole discretion) to replace or repair the product.

- 1.** This warranty is only provided upon presentation of the completed warranty card and original invoice or purchase receipt indicating the date of purchase, product type and dealer's name, together with the product. Nikon reserves the right to refuse free-of-charge warranty service if the above documents cannot be presented or if the information contained in it is incomplete or illegible.

**2.** This warranty will not cover:

- necessary maintenance and repair or replacement of parts due to normal wear and tear.
- modifications to upgrade the product from its normal purpose as described in user manuals, without the prior written consent of Nikon.
- transport costs and all risks of transport relating directly or indirectly to the warranty of the products.
- any damage resulting from modifications or adjustments which may be made to the product, without the prior written consent of Nikon, in order to comply with local or national technical standards in force in any other country than the ones for which the product was originally designed and/or manufactured.

**3.** The warranty will not be applicable in the case of:

- damage caused by misuse including but not limited to failure to use the product for its normal purpose or according to the user instructions on the proper use and maintenance, and to installation or use of the product inconsistent with the safety standards in force in the country where it is used.
- damage caused by accidents including but not limited to lightning, water, fire, misuse or neglect.
- defacing, illegibility or removal of the model or serial number on the product.
- damage resulting from repairs or adjustments which have been conducted by unauthorized service organizations or persons.
- defects in any system into which the product is incorporated or with which it is used.



4. This service warranty does not affect the consumer's statutory rights under applicable national laws in force, nor the consumer's right against the dealer arising from their sales/purchase contract.

**Notice:** An overview of all authorized Nikon Service Stations can be found online by following this Link

(URL = <https://www.europe-nikon.com/service/>).

No reproduction in any form of this document, in whole or in part (except for brief quotation in critical articles or reviews), may be made without written authorization from NIKON CORPORATION.

Out of concern for the environment, Nikon is working to reduce its use of paper.

**NIKON CORPORATION**

---

© 2023 Nikon Corporation



6MO05911-02