

Noirot Spot Plus Digital Timer



Electric Convection Panel Heater

**Operating & Installation
Instructions**

**In Order To Qualify For Your
Lifetime Warranty**

Please Visit our Website and complete the Online Registration

www.noirotd.com.au

RECOMMENDATION FOR WALL INSTALLATION

This heater is sold ready for DIY installation, with Wall bracket and flexible cord supplied. To remove the wall bracket from the heater you need to push down on the spring loaded clips located at the top of the bracket. This can be done by using your fingers or, if preferred, a screwdriver (No: 1 Fig.1). Fit the wall bracket to the wall with suitable fixing method according to the surface you mount the heater on (not included). Place the heater on to the bracket and clip into position.

Note: To centre your appliance laterally on the wall, use the hole marked 2.

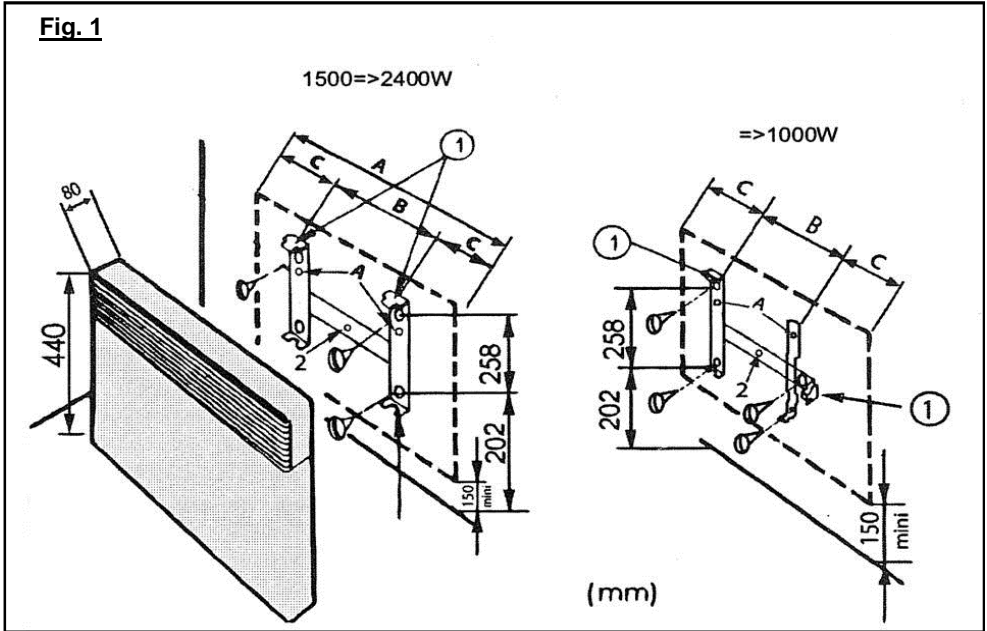

Model	Height	A	B	C
7358-3T	440	420	208	106
7358-5T	440	580	178	201
7358-7T	440	745	320	210
7358-8T	440	900	405	248

The heater must not be located immediately below a socket outlet (as per requirement of Clause 7.12 of AS/NZS 60335.2.30).

For maximum efficiency, this heater is to be wall mounted between a minimum height of 100mm and a maximum height of 150mm off the floor. This is to allow the necessary volume of air to flow freely through the vents. It is also important to allow a minimum of 100mm clearance at the top and sides of the heater and 500mm from the front (Fig. 2) so as not to force the air back into the heater and activate the Over Temperature Safety Thermal Cut-Out Switch.

WARNING: IN ORDER TO AVOID OVERHEATING, DO NOT COVER THE HEATER

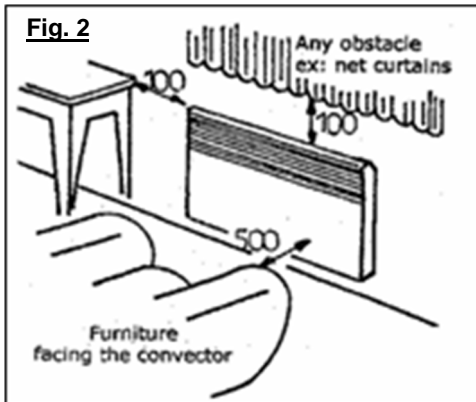

If the “Over Temperature Safety Thermal Cut-Out Switch” is activated, the heater will automatically switch off to limit the temperature to a safe value. To reset the thermal cut-out, simply switch the heater off, unplug it from the power point and remove the obstruction(s). Plug the heater back in and switch it on. The thermal cut-out switch will reset after a few minutes and the heater will function normally.

PANEL LOCATIONS

This heater is suitable for use in all rooms including Zone 2 in Bathrooms (Fig.3) in accordance with AS/NZS 3000: 2000 (Wiring Rules). Although this heater is double insulated and does not require earthing, **for use in the bathroom it must be located so that the controls cannot be touched by a person in the bath or shower.**

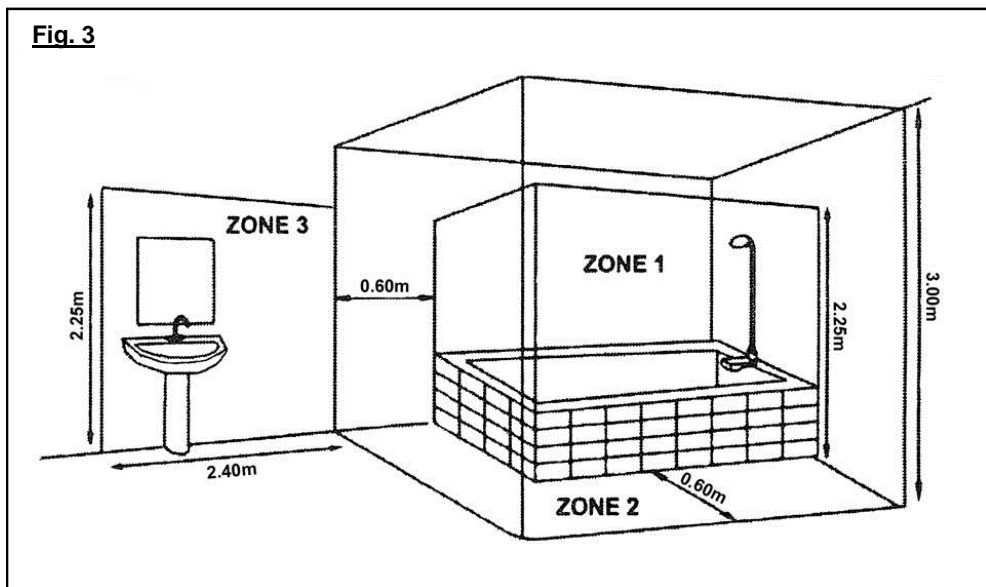

RECOMMENDATION FOR USE WITH CASTORS

This heater is tested and approved for use with the optional “Easy Glide Castors”. Please follow the fitting instructions (supplied with the castors) closely, ensuring the **BLACK CLIPS** are correctly installed. Note that once the **BLACK CLIPS** are fixed into position, the castors **CANNOT** be removed without breaking them.

WARNING: **DO NOT** use the heater on the floor without the “Easy Glide Castors”.

ELECTRICAL CONNECTION

This heater is fitted with an Australian Approved Flexible Cord and Plug. For wall-mounted installations connection can be either by plugging into an existing 10 amp power point (DIY) or direct wired by a Licensed Registered Electrical Contractor, who is required to issue a Certificate of Electrical Safety.

PLEASE NOTE: For safety reasons the Flexible Cord must not be modified or repaired in any way. If the Cord is damaged, it must be replaced by a Noirot appointed and approved service agent. If there are any concerns, contact Noirot Australia Pty Ltd on 1 300 664 768 before plugging it in.

IMPORTANT: **DO NOT** plug heater into a Power Board, Double Adaptor or Extension Lead.

USING YOUR HEATER FOR THE FIRST TIME

Remove the heater from its packaging (please dispose of packaging responsibly).

Contents should be as follows:

1. Heater
2. Wall bracket (pre-attached to the back of the heater)
3. Instructions for installation and use (8 page booklet)

Ensure the heater is correctly mounted on the wall or fitted to the castors prior to turning it on. Remove the white plastic protective covers from the plug pins and insert the plug into the wall socket.

This appliance is not intended for use by persons (including children) with reduced physical, sensory or mental capabilities, or lack of experience and knowledge, unless they have been given supervision or instruction concerning use of the appliance by a person responsible for their safety. Children should be supervised to ensure that they do not play with the appliance.



NOTE: When the heater is turned on for the first time, or after it has been off for a long period, such as during the summer months, you may experience a slight burning smell. This is quite common and should disappear after a few minutes. If it should persist, switch the heater off and have it inspected.

THE MR190 DIGITAL CONTROLLER



On/Standby: Press  to turn the heater **ON** or return it to **STANDBY** Mode



Mode Selector: The **MODE** button enables the heater to operate in the following 3 modes (shown by the different symbols along the bottom of the display):

Mode	Display	Description
TIMER		Heater operates only during heating periods
COMFORT		Heater operates continuously at the set temperature
FROST-PROTECTION		Heater operates continuously at 7°C (frost-protection)

MANUAL HEATER OPERATION

Ensure your heater is correctly installed or mounted on castors, plugged in and turned on at the power point on.

Press  to turn the heater ON and ensure the mode is set to COMFORT.

Use the  and  buttons to set the required room temperature. The temperature is increased or decreased in 0.5°C increments and ranges from 11°C to a maximum of 27°C.

The  symbol on the display indicates that the element is energised. Once the room temperature has stabilised, the heating element will cycle on and off to maintain the room temperature.

Press  to return the heater to STANDBY mode

SETTING THE TIME



Press the  button.

Press the  button for 2 seconds to enter the programming mode



The Day will now be blinking 

Press the  button again, this time for 3 seconds to enter the time setting mode

The Hour will now be flashing 

Use the  and  buttons to set the current hour, then press  to confirm

The Minutes will now be flashing.

Use the  and  buttons to set the current hour, then press  to confirm

The Day will now be flashing.

Set the current day (i.e. 1 for Monday, 2 for Tuesday, etc.), then press  to confirm.

The time and day are now set.

To display the current time during normal operation, briefly press the  button.



The time will be displayed for 3 seconds.

PROGRAMMING THE TIMER

It is possible to set up to 3 On/Standby periods per day using the timer mode. Each day can be programmed individually or all days can be programmed at once.



Press the  button for 2 seconds to enter the programming mode

The Day will now be blinking 

Use the  and  buttons scroll to the required day. Note that after Day 7, 'ALL' will be displayed. Use this setting to program every day.

Press the  button to confirm

Period 1 settings are now displayed

Use the  and  buttons to select the time that you want the heater is to turn **ON**.

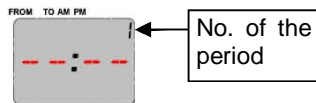

When a time is displayed a red triangle appears on the display below **FROM**



Press the  button to confirm

Use the  button to select the time that you want the heater is to return to **STANDBY**

The red triangle is now displayed below **TO**, indicating the time the heater is set to revert to **STANDBY** mode.





Press the  button to confirm

Period 2 settings are now displayed. Repeat the above steps for Period 1 to set the times that the heater is to turn **ON** and return to **STANDBY**.

If no more On/Standby periods are required for the day, continue to  press until the Day is again displayed.





Repeat the above steps for each day heating periods are required.

To exit to programming mode press  until the **DAY** is displayed. Press the  button until **EXIT** is displayed on the display.

Press the  button to confirm to exit programming



Briefly pressing the  button when the heater is in AUTO Mode will display the time left in a heating period or the lapsed time until the next heating period starts. **No Pr** is displayed if no more heating periods are programmed for that day.

Note: The temperature can be adjusted at any time during a heating period. Simply press the  or  buttons to adjust the room temperature.

CHILD LOCK

Press both the **+** and **-** buttons together until the  is displayed on the screen.

This indicates that the child lock is activated, disabling the buttons on the keypad.



To re-activate the keypad, press both **+** the **-** and buttons together until the key disappears

MAINTENANCE

Your Noirot Electric Panel Heater requires very little maintenance. To remove surface dust use a soft cloth; to remove marks use a damp cloth. Never use abrasives or metal scourers which could damage the polyester coating. It is recommended to periodically clean the air vents using the soft brush on your vacuum cleaner, as dense accumulation of dust will cause the heater to over-heat and trigger the safety thermal cut-out switch.

SPECIFICATIONS:

Model	Power (W)	Current (A)	Height	A	B	C
7358-3T	1000	4.2	440	420	208	106
7358-5T	1500	6.3	440	580	178	201
7358-7T	2000	8.3	440	745	320	210
7358-8T	2400	10.0	440	900	405	248

Please note: Heater temperature settings will vary from house to house according to the building type and its level of insulation. They will also vary from room to room, depending on factors such as room orientation (facing north or south) and window sizes. Items such as computers and lights (which generate heat) and people will also affect a room's temperature.

Running costs are not wholly governed by the temperature setting on the panel heater. The same maximum power is used to reach 11° or 27°. Where the energy efficiency and economy is obtained is in the sizing of the heater to the particular room where it is to be used. If the heater is sized correctly, then the thermostat will cycle on & off as required to maintain your comfort level, no matter where on the scale your comfort setting is.

WARRANTY REGISTRATION:

IMPORTANT: To validate your product warranty, you are required to do the following:

1. Register your product online at www.noirot.com.au, click on “Product Registration” and fill out the required fields.
2. You must also retain your receipt of purchase

WARRANTY CONDITIONS

Your Noirot Spot Plus electric panel heaters comes with a **LIFETIME WARRANTY**, therefore any replacement of faulty parts or repairs of any kind must be carried out by a qualified person and authorised by Noirot Australia Pty Ltd or their approved representative. Failure to do so will **VOID** the **WARRANTY**.

Noirot Australia Pty. Ltd. reserve the right to reject any warranty claim deemed to be false. Retailers must have warranty claims authorised by a representative of Noirot Australia.

If you believe your product to be faulty and under warranty you are required to do the following:

1. Return the product, at your expense, to the place of purchase for assessment by an authorised representative of Noirot Australia.
2. This may require leaving the product at the place of purchase.
3. If the product is deemed faulty and under warranty, the place of purchase of the product will order a replacement heater to which Noirot Australia, at our cost, will deliver the heater to the place of purchase.
4. The consumer will then be required, at their cost, to pick up the replacement heater from the place of purchase.
5. If the heater is faulty but not deemed to be under warranty, an explanation will be provided to the consumer and that the faulty heater can be picked up by the customer from the place of purchase.

Our goods come with guarantees that cannot be excluded under the Australian Consumer Law. You are entitled to a replacement or refund for a major failure and for compensation for any other reasonably foreseeable loss or damage. You are also entitled to have the goods repaired or replaced if the goods fail to be of acceptable quality and the failure does not amount to a major failure.

If you have any queries regarding your product or its warranty please contact:

Noirot Australia Pty Ltd

80-84 Burlington St
Oakleigh Victoria 3166
Australia

P: 1 300 664 768

E: sales@noirot.com.au

Noirot New Zealand Pty Ltd

19B Orbit Drive
Rosedale Auckland 0622
New Zealand

P: (09) 476-7981

E: sales@noirot.co.nz