

Panasonic®

Operation Instruction and Cook Book Microwave/Grill/Convection Oven Household Use Only

INVERTER



Model Number: **NN-CF770M**

Please read these instructions carefully before using this product, and save this manual for future use.

We are glad you have chosen to purchase a PANASONIC microwave oven. Before operating this oven, please read these instructions carefully and completely, and keep them for further reference.

If you have only used a microwave oven for reheating and defrosting, with Panasonic's Inverter Technology you can be reassured of excellent results when cooking a variety of foods, as the 'soft' penetration of microwave energy to the centre of food helps prevent over cooking on edges and surfaces. Foods can now be gently simmered without the concern of boil over.

After reading the introductory chapter, we are sure you will be able to master the basic techniques and thereby develop a firm understanding of your new oven. This book includes recipes from starters to desserts. After trying our recipes be sure to adapt your favourite recipes to microwave methods.

Start experimenting now, and enjoy the first class results you will achieve by using your new microwave oven.

Panasonic Australia Pty. Ltd.
Locked Bag 505
Frenchs Forest NSW 1640



PANASONIC NZ LTD
CUSTOMER CARE CENTRE
350 Te Irirangi Drive
East Tamaki, Auckland
Private Bag 14911
Panmure, Auckland

Phone: (09) 272-0178
Fax: (09) 272-0134

PANASONIC CONSUMER
COMPANY
Unit 10, Growthpoint Business
Park, Tonnetti Street, Halfway
House, Midrand 1686
P.O Box 1711, Halfway
House, 1685, South Africa
Customer Support Centre: 086 11 77 777
Fax: (011) 313-1706

The serial number of this product may be found at the left side of the control panel. You should note the model number and serial number of this oven in the space provided and retain this book as a permanent record of your purchase for future reference.

MODEL NUMBER _____

SERIAL NUMBER _____

DATE OF PURCHASE _____

Table of Contents

Before Operation

Safety Instructions.....	1
Installation and General Instructions.....	2
Microwaves and How They Work.....	3
Cookware and Utensils Guide	3-4
Feature Diagram	5
Control Panel	6
Display Window.....	6
Ingredient Conversion Chart	17

Operation and Hints

Let's Start to Use Your Oven	7
Operation Guide in the Display Window	7
To Set Clock.....	8
To Use Child Safety Lock.....	8
To Use Timer Button	21
To Cook	
by Micro Power and Time	9
on Grill by Time Setting.....	12
on Combination by Time Setting	13
on Convection by Time Setting	14-15
using the Recipe Store Button	16
using Auto Cook Buttons and Menus.....	18-20
To Reheat	
by Micro Power and Time	9
using Auto Reheat Button	17
To Defrost	
by Micro Power and Time	9-10
using Turbo Defrost Button	10-11
3-Stages Setting.....	16
Quick Guide to Operation	27-28

Maintenance

Before Requesting Service	22-23
Care of Your Oven	24
Technical Specifications.....	25
Panasonic Warranty.....	26

Cookbook

Microwave Recipe Preparation and Techniques	29-31
Reheat	32-34
Soups and Snacks.....	35-36
Fish and Shellfish.....	37-39
Poultry and Eggs.....	40-44
Meat	45-48
Vegetables and Legumes	49-53
Rice, Pasta and Noodles	54-57
Cakes, Desserts and Slices	58-64
Sauces and Extras.....	65-66
Bread and Pizza.....	67

Safety Instructions

Precautions to be taken when using Microwave Ovens for Heating foodstuffs

INSPECTION FOR DAMAGE. A microwave oven should only be used if an inspection confirms all of the following conditions:

1. The door fits squarely and securely and opens and closes smoothly.
2. The door hinges are in good condition.
3. The metal plates of a metal seal on the door are neither buckled nor deformed.
4. The door seals are neither covered with food nor have large burn marks.

PRECAUTIONS. Microwave radiation from microwave ovens can cause harmful effects if the following precautions are not taken:

1. Never tamper with or deactivate the interlocking devices on the door.
2. Never poke an object, particularly a metal object, through a grille or between the door and the oven while the oven is operating.
3. Never place saucepans, unopened cans or other heavy metal objects in the oven.
4. Do not let other metallic articles, e.g., fast food foil containers, touch the side of the oven.
5. Clean the oven cavity, the door and the seals with water and a mild detergent at regular intervals. Never use any form of abrasive cleaner that may scratch or scour surfaces around the door.
6. Always use the oven with the cookware recommended by the manufacturer.
7. Never operate the oven without a load (i.e., an absorbing material such as food or water) in the oven cavity unless specifically allowed in the manufacturer's literature.
8. For horizontally hinged doors, never rest heavy objects such as food containers on the door while it is open.
9. Do not place sealed containers in microwave ovens. Baby bottles fitted with a screw cap or a teat are considered to be sealed containers.
10. This appliance is not intended for use by persons (including children) with reduced physical, sensory or mental capabilities, or lack of experience and knowledge, unless they have been given supervision or instruction concerning use of the appliance by a person responsible for their safety.
11. Young children should be supervised to ensure that they do not play with the appliance.

Important Instructions

WARNING—To reduce the risk of burns, electric shock, fire, injury to persons or excessive microwave energy:

1. Read all instructions before using the microwave oven.
2. Some products such as whole eggs and sealed containers - (for example, closed glass jars **and sealed baby bottles with teat**) - may explode and should not be heated in the microwave oven.
3. Use this microwave oven only for its intended use as described in this manual.
4. As with any appliance, close supervision is necessary when used by children.
5. Do not operate this microwave oven if it is not working properly or if it has been damaged or dropped.

6. To reduce the risk of fire in the oven cavity:
 - (a) Do not overcook food. Carefully attend microwave oven if paper, plastic, or other combustible materials are placed inside the oven to facilitate cooking.
 - (b) Heating therapeutic wheat bags is not recommended. If heating, do not leave unattended and follow manufacturers' instructions carefully.
 - (c) Remove wire twist-ties from bags before placing bag in oven.
 - (d) If materials inside the oven should ignite, keep oven door closed, turn oven off at the wall switch, or shut off power at the fuse or circuit breaker panel.
 - (e) Never leave microwave unattended while cooking or reheating.
7. Failure to maintain the oven in a clean condition could lead to deterioration of the surface that could adversely affect the life of the appliance and possibly result in a hazardous situation.

Earthing Instructions

This microwave oven must be earthed. In the event of an electrical short circuit, earthing reduces the risk of electric shock by providing an escape wire for the electric current. This microwave oven is equipped with a cord having an earthing wire with an earthing plug. The plug must be plugged into an outlet that is properly installed and earthed. **WARNING**—Improper use of the earthing plug can result in a risk of electric shock.

WE CERTIFY THAT THIS MICROWAVE OVEN HAS BEEN INSPECTED AND COMPLIES WITH THE REQUIREMENTS OF REGULATION 3, SUBCLAUSE(2), OF THE MICROWAVE OVENS REGULATIONS 1982.

(This statement applicable only to New Zealand.)

We certify that this microwave oven has been inspected and complies with the safety requirements of government notice 466 of March 1981, and complies with the Radio Regulation of government notice 587 of March 1986.

(This statement applicable only to South Africa)

WARNING

- a) The door seals and door seal areas should be cleaned with a damp cloth. The appliance should be inspected for damage to the door seals and door seal areas and if these areas are damaged the appliance should not be operated until it has been repaired by a qualified service technician trained by the manufacturer.
- b) It is dangerous for anyone other than a qualified service technician trained by the manufacturer to perform repair services.
- c) If the supply cord of this appliance is damaged, it must be replaced by a qualified service technician with the special cord available only from the manufacturer.
- d) Before use, the user should check that whether the utensils are suitable for use in microwave ovens.
- e) Liquids or other foods must not be heated in sealed containers since they are liable to explode, at the same time it should avoid the boiling liquids splash.
- f) Only allow children to use the oven without supervision when adequate instructions have been given so that the child is able to use the oven in a safe way and understands the hazards of improper use.

Installation and General Instructions

General Use

1. In order to maintain high quality, do not operate the oven when empty. The microwave energy will reflect continuously throughout the oven if no food or water is present to absorb energy, this can lead to damage to the microwave oven including arcing within the oven cavity.
2. If smoke is observed, press the **STOP/RESET** Button and leave door closed in order to stifle any flames. Disconnect the power cord, and/or shut off power at the fuse or circuit breaker panel.
3. Do not dry clothes, newspapers or other materials in oven. They may catch on fire.
4. Do not use recycled paper products, unless the paper product is labelled as safe for microwave oven use. Recycled paper products may contain impurities which may cause sparks and/or fires when used.
5. Do not use newspapers or paper bags for cooking.
6. Do not hit or strike the Control Panel. Damage to controls may occur.
7. **POT HOLDERS** may be needed as heat from food is transferred to the cooking container and from the container to the Flat Table. The Flat Table can be very hot after removing the cooking container from the oven.
8. Do not store flammable materials next to, on top of, or in the oven. It could be a fire hazard.
9. Do not cook food directly on Flat Table unless indicated in recipes. (Food should be placed in a suitable cooking utensil.)
10. **DO NOT** use this oven to heat chemicals or other non-food products. **DO NOT** clean this oven with any product that is labelled as containing corrosive chemicals. **The heating of corrosive chemicals in this oven may cause microwave radiation leaks.**
11. Do not leave the microwave unattended while reheating or cooking food in disposable containers made of plastic, paper or other combustible materials, as these types of containers can ignite if overheated.

Placement of Oven

1. The oven must be placed on a flat, stable surface, more than 85 cm above the floor. For correct operation, the oven must have sufficient air flow. **Allow 25 cm of space on the top of the oven, 10 cm at the back, and 10 cm on both sides. If one side of the oven is placed flush to wall, the left side or top must not be blocked. Do not remove feet.**
 - a. Do not block air vents. If they are blocked during operation, the oven may be overheated and damaged. When using any cloth over the oven, the air intake and exhaust should not be blocked. Also allow sufficient space on back and both sides of the oven.
 - b. Do not place oven near a hot or damp surface such as a gas stove, electric range or sink etc.
 - c. Do not operate oven when room humidity is too high.
2. This oven was manufactured for household use only.
3. This oven is also designed for installation into a wall cabinet, use the proper trim kit available from a local Panasonic dealer. Follow all instructions packed with the kit.

Circuits

Your microwave oven should be operated on a separate 10 A circuit from other appliances. Failure to do this may cause the power board fuse to blow, and/or food to cook slower. Do not insert higher value fuse in the power board.

Food

1. Do not use your oven for home canning or the heating of any closed jar. Pressure will build up and the jar may explode. In addition, the microwave oven cannot maintain the food at the correct canning temperature. Improperly canned food may spoil and be dangerous to consume.
2. Do not attempt to deep fat fry in your microwave oven.
3. Do not boil eggs in their shell and whole hard-boiled eggs (unless otherwise stated in Cooking Guide section). Pressure will build up and the eggs will explode.
4. Potatoes, apples, egg yolks, chicken wings, whole squash and sausages are examples of foods with nonporous skins. This type of food must be pierced before cooking, to prevent bursting.
5. When heating liquids, e.g. soup, sauces and beverages, in your microwave oven, overheating the liquid beyond boiling point can occur without evidence of bubbling. This could result in a sudden boil over of hot liquid. To prevent this possibility the following steps should be taken:
 - a) Avoid using straight-sided containers with narrow necks.
 - b) Do not overheat.
 - c) Stir the liquid before placing the container in the oven and halfway through cooking time.
 - d) After heating, allow to stand in the oven for a short time, stirring again before carefully removing the container.
6. **DO NOT USE A CONVENTIONAL MEAT THERMOMETER IN THE MICROWAVE OVEN. To check the degree of cooking of roasts and poultry use a MICROWAVE THERMOMETER.** Alternatively, a conventional meat thermometer may be used after the food is removed from the oven. If undercooked, return meat or poultry to the oven and cook for a few more minutes at the recommended power level. It is important to ensure that meat and poultry are thoroughly cooked.
7. **COOKING TIMES given in the Cooking Guide section are APPROXIMATE.** Factors that may affect cooking time are preferred degree of moisture content, starting temperature, altitude, volume, size, shape of food and utensils used. As you become familiar with the oven, you will be able to adjust for these factors.
8. **It is better to UNDERCOOK RATHER THAN OVERCOOK foods.** If food is undercooked, it can always be returned to the oven for further cooking. If food is overcooked, nothing can be done. Always start with minimum cooking times recommended.
9. Extreme care should be taken when cooking popcorn in a microwave oven. Cook for minimum time as recommended by manufacturer. Use the directions suitable for the wattage of your microwave oven. **NEVER** leave oven unattended when popping popcorn.
10. When heating food in plastic or paper containers, check the oven frequently due to the possibility of ignition.
11. The contents of feeding bottles and baby food jars are to be stirred or shaken and the temperature is to be checked before consumption, in order to avoid burns.

Microwaves and How They Work

Microwaves are a form of high frequency radio waves similar to those used by a radio, including AM, FM and CB. They are similar to a television where the radio waves are converted to a picture on the screen. However, microwaves are much shorter than radio waves; approximately twelve centimetres wave length. Electricity is converted into microwave energy by the magnetron tube (which is the heart of the microwave oven).

The microwaves are converted to heat in the food. The microwaves enter from the outside of the food and travel through the food losing half of their power every two to three centimetres. Continued cooking to the centre occurs by conduction.

Although pacemakers used to be affected by microwaves (as well as by other radio waves), they are now shielded and are not bothered by these interferences. This allows people with pacemakers to sit calmly by their radio or television and cook with microwave ovens.

When microwaves come in contact with a substance, any one or combination of three things may occur.

They can be:

1. REFLECTED
2. TRANSMITTED
3. ABSORBED

Reflection:

Metal substances REFLECT microwave energy and because there is no absorption, there is no heating. This is why the oven interior is either stainless steel or epoxy-coated steel. This ensures that the microwaves are kept inside the cavity and evenly distributed throughout the food.

Transmission:

Such substances as paper, glass and plastic TRANSMIT microwave energy and do not become hot except from food. Because these substances do not reflect or absorb microwave energy, they are ideal materials for microwave cooking containers.

Absorption:

Food contains moisture and will ABSORB microwave energy, which causes the moisture molecules within the food to vibrate at an incredible rate (2,450,000,000 times per second). Friction, created by the vibration, produces heat energy which is conducted throughout the food.

Cookware and Utensils Guide

It is important to use the correct container when cooking in a microwave oven. The following will help you make the right selection.

How to Test a Container for Safe Microwave Oven Use

TO TEST A CONTAINER FOR SAFE MICROWAVE

OVEN USE: Fill a 1-cup glass measure with cool water and place it in the microwave oven alongside the empty container to be tested; **heat one (1) minute at High Power.** If the container is microwave oven-safe (transparent to microwave energy), the container should remain comfortably cool, the water in glass measure should be hot. If the container is hot, it has absorbed some microwave energy and should NOT be used. This test cannot be used for plastic containers.

Paper Products and Freezer Wrap

Waxed paper, paper plates, cups and napkins should not be used for heating or cooking food. Freezer wrap should not be used as it is not heat resistant and may melt. Paper towel, greaseproof paper and bake paper may be safely used for short periods of time for covering or lining.

Jars and Bottles

Jars and bottles can be used to warm food to serving temperature, if the lid is removed first. Cooking should not be done in these containers since most are not heat resistant and during extended heating times, heat from food would cause cracking or breaking.

Glass, Ceramic and China

Heat-Resistant glass cookware is invaluable in microwave cooking. Many of these items are readily available in most homes: glass jugs, mixing bowls, loaf dishes, covered casseroles, oblong baking dishes, pie plates and round or square cake dishes. Examples of this type of cookware are Pyrex® and Corningware®.

Dinnerware can be used for microwave heating. Many brands of dinnerware are microwave safe. Check the care information for reference to microwave use for dinnerware and serving pieces. If dinnerware is marked ovenproof, it frequently is safe to use in the microwave oven. However, to be sure, check by conducting microwave dish test.

Several types of glassware and dinnerware are not recommended for use in the microwave oven. Do not use dishes with metallic trim or containers with metal parts. Do not use cups or mugs with glued on handles, as they may fall off with continued heating. Do not use delicate glassware. Although the glassware may be transparent to microwave energy the heat from the food may cause the glassware to crack.

Straw, Wicker and Wood

Straw and wicker baskets may be used in the microwave oven for short periods of time to warm rolls or bread. Large wooden utensils, such as bowls or cutting boards should NOT be used for prolonged heating as the microwave energy may cause the wood to become dry and brittle.

Cookware and Utensils Guide *(continued)*

Plastics

Plastic dishes, cups and some freezer containers should be used with care in a microwave oven.

Choose plastic containers carefully, as some plastic containers may become soft, melt and may scorch. The majority of plastic dishes, even those designed for use in the microwave oven, are not suitable for cooking foods with high fat or sugar content, or for lengthy cooking times. Most microwave plastic dishes should not be used for longer than 3 to 5 minutes on **HIGH** power. These dishes, although not suitable for extended cooking, may be used successfully for defrosting or for use on lower power levels.

Cooking Bags designed to withstand boiling, freezing, or conventional heating are microwave safe. Prepare bags according to manufacturer's directions. When cooking by microwave, **DO NOT** use wire twist-ties to close bag. They can act as an antenna and cause arcing (sparks).

DO NOT COOK IN PLASTIC FOOD STORAGE BAGS.

Plastic Wrap such as GLAD WRAP® can be used to cover dishes in most recipes. Over an extended heating time, some disfiguration of the wrap may occur. When removing plastic wrap "covers", as well as any glass lid, be careful to remove it away from you to avoid steam burns.

Loosen plastic but let dish stand, covered.

Metal

Metal cookware or utensils, or those with metallic trim, should **NOT** be used in the microwave. Since

microwave energy is reflected by metal, foods in metal containers will not cook evenly. There is also a possibility of "arcing."

Although metal utensils should be avoided in microwave cooking, some metal can be helpful when used correctly.

Aluminum foil can be used safely, if certain guidelines are followed, to prevent overcooking. Small pieces of foil are used to shield areas such as chicken wings, tips of roasts, or other thin parts that cook before the rest of the recipe is finished. Make sure foil is attached securely and doesn't touch sides of oven, otherwise arcing may occur. Foil lined containers, either cardboard or plastic, should **NOT** be used in the microwave oven as arcing could occur.

Metal twist-ties, either paper or plastic coated, should **NOT** be used in the microwave oven. Frozen dinner trays can be used in the microwave, if the container is no deeper than 2 cm and is filled with food. Metal skewers can not be used in microwave ovens as arcing may occur. Wooden skewers are readily available and can be used.

Shells: Scalloped baking shells are best used during reheating and for short periods of cooking time only.

Thermometers are available for use in microwave ovens. **DO NOT USE CONVENTIONAL MERCURY TYPE CANDY OR MEAT THERMOMETERS** in food while cooking in the microwave oven.

Cookware and Utensil Chart

	Microwave	Grill	Convection	Combination
Aluminium foil	for shielding	yes	yes	for shielding
Brown paper bags	no	no	no	no
Dinnerware				
oven/microwave safe	yes	yes	yes	yes
non-oven, microwave safe	yes	no	no	no
Disposable paperboard containers	yes*	no	yes* (up to 220 °C)	yes* (up to 220 °C)
Glassware				
oven glassware & ceramic	yes	yes	yes	yes
non heat resistant	no	no	no	no
Metal cookware	no	yes	yes	no
Metal twist-ties	no	yes	yes	no
Oven cooking bag	yes	no	yes*	yes
Paper towels and napkins	yes	no	no	no
Plastic defrosting rack	yes	no	no	no
Plastic dishes				
microwave safe	yes	no	no	no
non microwave safe	no	no	no	no
Plastic wrap	yes	no	no	no
Straw, wicker, wood	yes	no	no	no
Thermometers				
microwave safe	yes	no	no	no
conventional	no	yes	yes	no
Waxed paper	yes	no	no	no
Silicon bakeware	yes	no	yes*	yes*

* Check manufacturers' recommendation, must withstand heat.

Feature Diagram

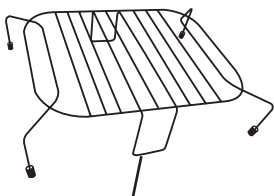
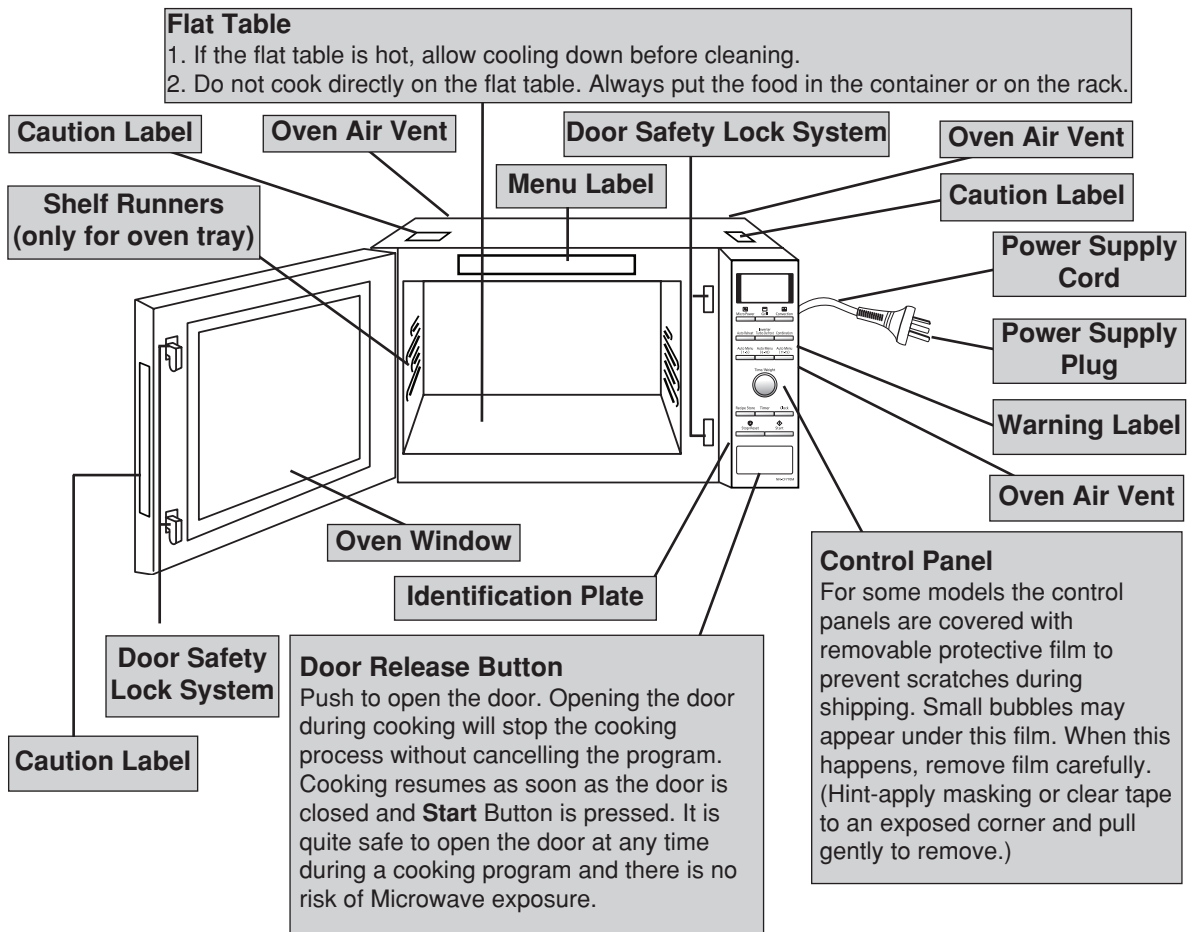

Wire Rack (High)
 Don't use it together with oven tray.

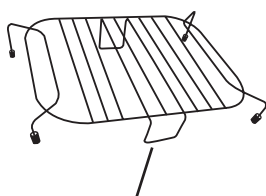

Wire Rack (Low)
 Don't use it together with oven tray.

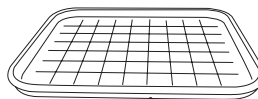

Glass Dish
 Never insert on shelf runners.

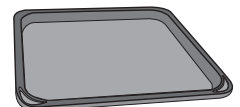

Oven Tray
 1. For convection, grill only.
 2. After cooking, allow tray to cool before handling.

Oven Light

Oven Light will turn on during cooking and also when door is opened.

NOTE:

The above illustration is for reference only.

Control Panel

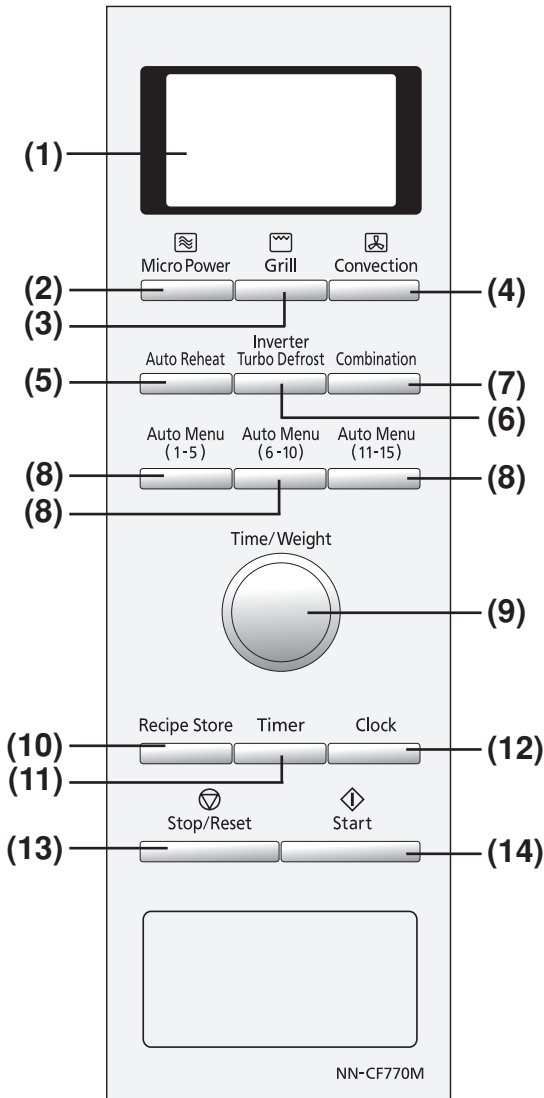

- (1) **Display Window**
- (2) **Micro Power Button** (pg.9)
- (3) **Grill Button** (pg.12)
- (4) **Convection Button** (pg.14-15)
- (5) **Auto Reheat Button** (pg.17)
- (6) **Inverter Turbo Defrost Button** (pg.10)
- (7) **Combination Button** (pg.13)
- (8) **Auto Cook Buttons** (pg.18)
- (9) **Time/Weight Dial**
Press and release dial to expand (pop-out). After setting desired program, push dial in to avoid accidental changing of the Programmed time.
- (10) **Recipe Store Button** (pg.16)
- (11) **Timer Button** (pg.21)
- (12) **Clock Button** (pg.8)
- (13) **Stop/Reset Button**
Before cooking: One tap clears all your instructions.
During cooking: One tap temporarily stops the cooking process. Another tap cancels all your instructions and colon or time of day appears in the Display Window.
- (14) **Start Button**
One tap allows oven to begin functioning. If door is opened or **Stop/Reset Button** is pressed once during oven operation, **Start Button** must be pressed again to restart oven.

Word Prompters

When a button is pressed correctly, a beep sound will be heard and the corresponding letter or word(s) appear and roll across the Display Window. If a button is pressed and no beep is heard, the unit did not or could not accept the instruction. As each button is pressed the corresponding word(s) roll across the Display Window. Words will automatically appear to prompt the user to perform the next step. It is not necessary to wait for the words to appear before pressing buttons for the next step. A two beep sound is heard between stages. At the end of any complete programme, the oven will beep five times and "ENJOY YOUR MEAL" will appear in the Display Window.

Note:

If an operation is set and **Start Button** is not pressed, after 6 minutes, the oven will automatically cancel the operation. The display will revert back to clock or colon mode.

Display Window

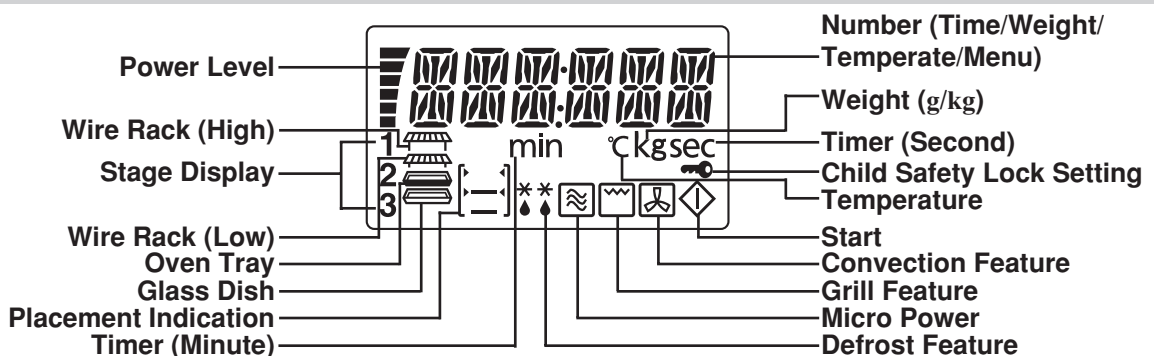

Let's Start To Use Your Oven!

1 Plug in

Plug into a properly earthed electrical outlet. "WELCOME TO PANASONIC MICROWAVE OVEN COOKING" appears in the Display Window. (This will immediately cease when any pad is pressed.)

2 Open Door

Open the door and place container with food on Flat Table in the oven. Then close the door.

3 Select Micro Power Level

e.g. Med-High Power
Press **Micro Power** Button twice.
(see page 9 for Micro Power chart)



4 Set Time

e.g. 1 minute 30 seconds
Rotate the **Time/Weight** dial until the desired time appears in the display window.

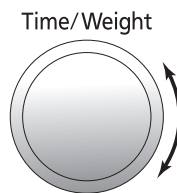

Verify your selection(s) in the Display Window.

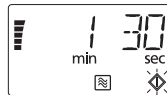

5 Press



Operation Guide in the Display Window

To assist you in programming your oven, the following operation will appear in the Display Window. When you become familiar with your oven, the Operation Guide can be turned off.

To turn off:



To turn on:



To Set Clock

You can use the oven without setting the clock.

Clock

1 Press once.

Colon will blink in Display Window.

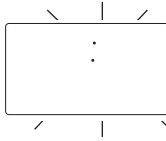

2 Enter Time of Day

Enter time of day using the **Time/Weight** Dial e.g. 12:35.
Clock is a 12 hour display. There isn't a.m. or p.m. setting.

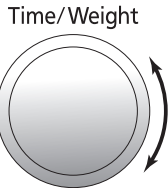

Clock

3 Press once

Colon stops blinking; time of day is entered and locked into Display Window.

NOTES: 1. Oven will not operate while colon is still blinking

2. To reset time of day, repeat step 1 through 3.

3. The clock will keep the time of day as long as oven is plugged in and electricity is supplied.

4. Maximum time available is 12:59. Clock is 12 hour only. One o'clock will be displayed as 1:00 not 13:00.

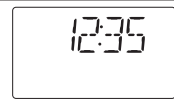

To Use Child Safety Lock

This feature allows you to prevent operation of the oven by a young child; however, the door will open. You can set Child Safety Lock when colon or time of day is displayed.

To set:

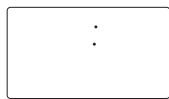

or



Colon or time of day is displayed



Start



Press 3 times.

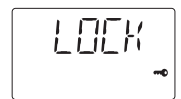

Display Window

To cancel:

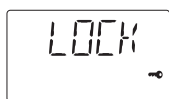

Display Window



Stop/Reset



Press 3 times.

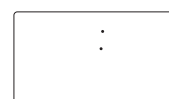

or

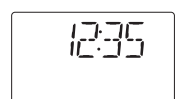

Colon or time of day is displayed

NOTE:

To set or cancel child safety lock, **Start** button or **Stop/Reset** button must be pressed 3 times within 10 seconds.

To Cook / Reheat / Defrost by **Micro Power and Time**

1 Select Micro Power Level

Press **Micro Power** Button until the desired power level appears in the Display Window. (see chart below)



Note: When selecting High on the first stage, you can start from step 2.

2 Set Cooking Time

Select the cooking time by using the **Time/Weight** Dial.

(High power: maximum up to 30 minutes, other power levels: up to 1 hour 30 minutes for a single stage)

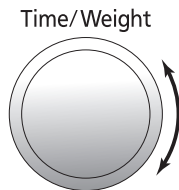

3 Press



Cooking will start.

The time in the Display Window will count down.

For more than one stage cooking,

Repeat steps 1 & 2 above then press **Start**. The maximum number of stages for cooking is 3. The oven will beep twice between stages. For the details, please refer to page 16.

Micro Power:

The **Micro Power** Button gives you a selection of different power levels representing decreasing amounts of microwave energy, used for cooking foods at different speeds.

e.g. The lower the micro power setting, the more evenly the food cooks, although it will take a little longer.

To select the correct power level for cooking different foods, refer to the chart below.

Press	POWER LEVEL	Display	EXAMPLE OF USE
1x	HIGH		Boil water. Reheat. Cook vegetables, rice, pasta and noodles.
2x	MED-HIGH		Cook poultry, meat, cakes, desserts. Heat milk.
3x	MEDIUM		Cook beef, lamb, eggs, fish and seafood. Melt butter.
4x	MED-LOW		Simmer soups, stews and casseroles (less tender cuts).
5x	DEFROST		Thaw foods.
6x	LOW		Keep cooked foods warm, simmer slowly.

NOTE:

After using the oven, the fan may rotate to cool the electric components and "COOL" appears in the display window. If you cook using microwave, "COOL" will appear after micro cooking over 3 minutes. This is perfectly normal, and you can take out the food from the oven while the fan operates.

To Defrost

Turbo Defrost

This feature allows you to defrost meat, poultry and seafood automatically by just setting the weight of the food.

1 Select Inverter Turbo Defrost Button

The shape and size of the food will determine the maximum weight the oven can accommodate. The recommended maximum weight of food depends on the oven cavity size. Weight must be programmed in kilograms and tenths of a kilogram (0.1 kg ~ 3.0 kg).



Press once.

2 Set Weight

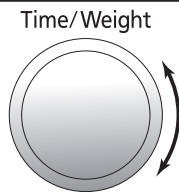

Set the defrost weight by using the **Time/Weight** Dial. When selecting 0.1 kg, you can skip this step.



3 Press



Defrosting time appears in the Display Window and begins to count down. When cooking time is longer than 60 minutes, the time will appear in hours and minutes.

NOTES:

For further information, refer to next page.

Defrost by Micro Power and Time Setting

Defrosting is done on DEFROST Power

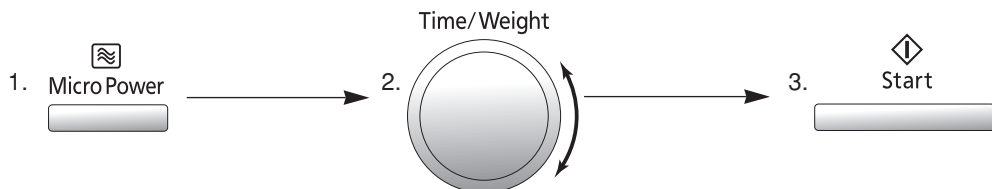

- Press 5 times for Defrost.
- Set time according to chart on page 11.
- Press.

The Display Window appears:



Defrosting Tips and Techniques

Preparation for Freezing:

1. Heavy-duty plastic wraps, bags and freezer wrap are suitable.
2. Freeze meats, poultry and fish in packages with only 1 or 2 layers of food. To aid in separating layers, place two pieces of wax paper between them.
3. REMOVE ALL AIR and seal securely.
4. LABEL package with type and cut of meat, date and weight.
5. Defrosting times given in the charts are for thoroughly frozen foods (i.e. at least 48 hours in freezer maintained at -18°C or lower).

Defrosting Technique:

1. Remove from wrapper and set on a defrosting rack in a dish on Flat Table.
2. On Turbo Defrost, the oven will beep during the defrosting time if defrosting weight is 0.4 kg ~ 3.0 kg. At "beep", turn over all meat, poultry, fish and shellfish. Break apart stewing meat, chicken pieces and minced meat. Separate chops and hamburger patties. Shield thin ends of roasts, poultry legs and wings, fat or bones with foil.
3. Throughout the defrosting time, remove any defrosted portions of mince or cubed meat, etc.
4. After defrosting, large roasts may still be icy in the centre. Let stand, 15 to 30 minutes, in refrigerator to complete defrosting.

Defrosting Chart (by setting Micro Power at Defrost):

FOOD	APPROX. TIME (minutes per 500 g)	INSTRUCTION
MEAT		
Beef		
Minced Beef	8 - 11	Halfway through the defrost cycle, break apart minced beef, separate chops and remove meat that is defrosted.
Roast: Topside	12 - 15	
Beef Tenderloin	12 - 15	
Chuck or Rump	10 - 13	Turn meat over two to three times during defrosting.
Sirloin, rolled	11 - 14	
Steak	8 - 10	Shield edges and unevenly shaped ends of roasts halfway through the defrost cycle.
Miscellaneous	8 - 12	
Pork/Lamb		
Roast	9 - 12	Large roasts may still be icy in centre. Let stand.
Chops	8 - 11	
Ribs	8 - 12	
POULTRY		
Chicken		
whole	9 - 12	Turn poultry over two to four times during defrosting. Halfway through the defrost cycle, shield end of drumsticks, wings, breast bones and ends of poultry with foil.
pieces	8 - 11	
fillets	8 - 10	Break apart chicken pieces and remove small pieces such as wings, which may be defrosted before larger pieces.
Duck	10 - 12	
Turkey	10 - 13	Rinse poultry under cold water to remove ice crystals. Let stand 5 to 10 minutes, before cooking.
FISH & SHELLFISH		
Fish Fillets	9 - 11	Halfway through the defrost cycle, turn whole fish or blocks of fillets over. Also, break apart prawns or scallops.
Whole Fish	9 - 12	
Crabmeat	8 - 10	Remove any pieces that are defrosted.
Lobster Tails	8 - 10	
Sea Scallops	8 - 10	Let stand, 5 to 10 minutes, before cooking.
Green Prawns	10 - 12	

To Cook on Grill by Time Setting

There are three grill setting modes. (1-High, 2-Medium, 3-Low)

Directions for Grill Cooking:

There are three power levels for grill. When grilling, heat is radiated from the two heater. The oven door must be kept closed to prevent cooking odours from spreading in the kitchen and so as not to waste energy. The grill is especially suitable for thin slices of meat and seafood as well as bread and meals.

Preheating isn't required before grilling. Select Grill setting, set the time and start the oven. The food being grilled should normally be turned over after half the grilling time. When the oven door is opened, the program is interrupted. Turn the food over, place it back the oven, close the door and restart oven. While grilling, the oven door can be opened at any time to check the food.

1 Select Grill Setting



Press **Grill** Button until the desired level appears in the Display Window. (see below chart)

Press	Display	Type of Food
1x	☐ ☐ ☐ ☐ ☐	Meat, Poultry pieces
2x	☐ ☐ ☐	Seafood
3x	☐ ☐	Garlic Bread, Toast

2 Set Cooking Time

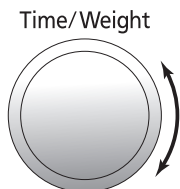

Set the desired cooking time by using **Time/Weight** Dial. (max. 1 hour 30 minutes)



3 Press

Cooking will start.

The time in the Display Window will count down.

To Cook on Combination by Time Setting

There are three combination setting modes. There is no need to set the temperature or the Micro Power Level.

Directions for Combinations Cooking:

The combination means that it is possible to combine the microwave and grill function for thawing, cooking, and heating foods. It's a good way for roasting foods by combining microwave and grill effectively. It's suitable for roasting poultry, meat and seafood. This function can ensure the foods cook evenly and retain their crispness as well as browning of certain foods. Please turn over the foods when half of the cooking time has elapsed, then continue cooking.

1 Select Combination Setting

Combination



Press **Combination** Button until the desired level appears in the Display Window. (see below chart)

Press	Display	Type of Food
1x		Whole poultry
2x		Beef, Lamb
3x		Sea food, Puddings

2 Set Cooking Time

Time/Weight

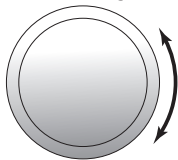

Set the desired cooking time by using **Time/Weight** Dial. (max. 9 hours)



Start

3 Press



Cooking will start.

The time in the Display Window will count down.

To Cook on Convection by Time Setting

This Pad offer a choice of convection temperatures 40 °C and 100 °C ~250 °C in 10 °C increments. For quick selection of the most commonly used cooking temperatures, the temperatures start at 150 °C and count up to 250 °C then 40 °C and 100 °C.

Without Preheating:



Convection

1 Press to select the desired temperature. (100 °C~250 °C)

The oven starts at 150 °C. Press the button and the temperature will count up in 10 °C stages to 250 °C, then 40 °C and 100 °C.

2 Set Cooking Time

Time/Weight

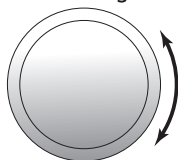

Set the desired cooking time by using **Time/Weight** Dial. (max. 9 hours)



Start

3 Press

The cooking time appears in the display window and begins to count down.

With Preheating:



Convection

1 Press to select the desired temperature. (100 °C~250 °C)

The oven starts at 150 °C. Press the button and the temperature will count up in 10 °C stages to 250 °C, then 40 °C and 100 °C.



Start

2 Press to preheat

"PREHEAT" roll across the Display Window. Then "P" appears in the Display Window.

After the oven is preheated, the oven will beep 3 times and the "P" will flash. Then open the door and place the food into oven immediately. There is no preheat at 40 °C.

3 Set Cooking Time

Time/Weight

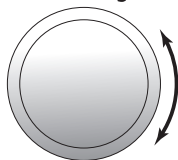

Set the desired cooking time by using **Time/Weight** Dial. (max. 9 hours)



Start

4 Press

The cooking time appears in the display window and begins to count down.

To Cook on Convection by Time Setting

Ferment Setting (For proving yeast dough)



Convection

1 Press  **to set 40 °C**

2 Set ferment time

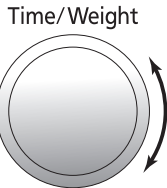

Set desired ferment time by using **Time/Weight** Dial. (max. 9 hours)



Start

3 Press 

The cooking time appears in the display window and begins to count down.

Placement of Oven Tray

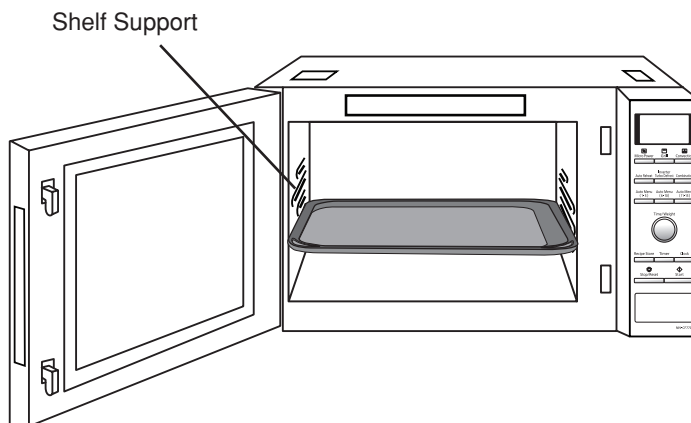

When using the oven tray, please insert into the support shelf as illustrated in the figure. Do not put oven tray directly on top of the support shelf or Flat Table to avoid the risk of fire.

3-Stages Setting

This feature allows you to program 3 Stages of cooking continuously.

E.g.: Continually set [Medium power] 2 minutes, [Combination High] 3 minutes and [Grill High] 2 minutes.

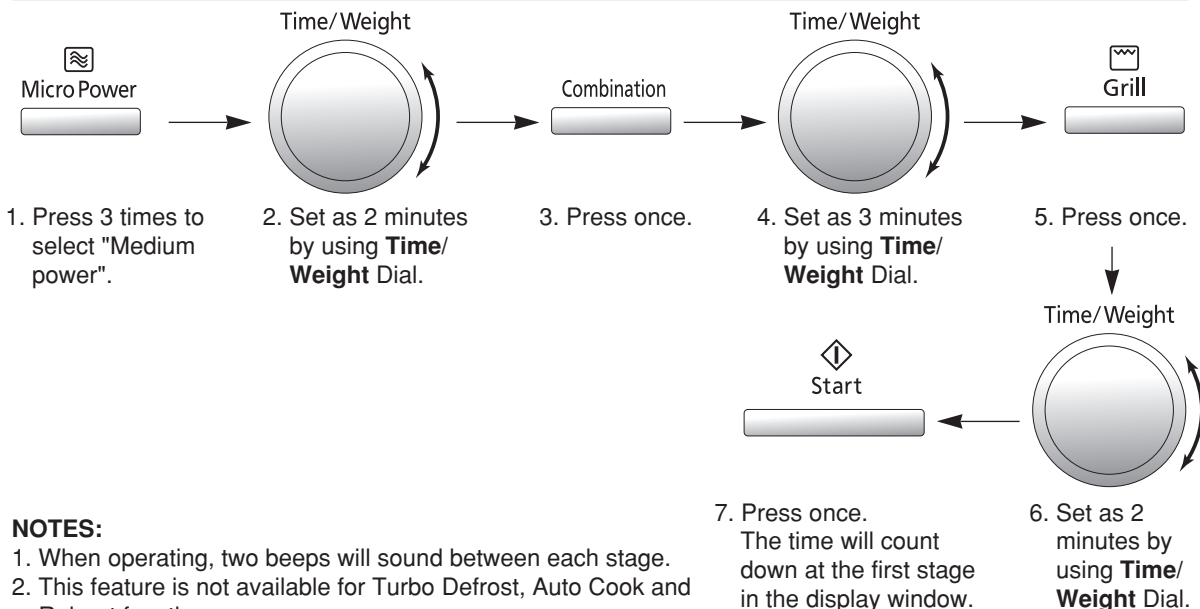

NOTES:

1. When operating, two beeps will sound between each stage.
2. This feature is not available for Turbo Defrost, Auto Cook and Reheat function.

To Cook using the Recipe Store Button

This feature allows you to pre-program your oven for regular reheating or cooking tasks. You are able to pre-program your oven for a specific power level and time that is convenient for you. You are able to pre-program three memory tasks.

To Set a Recipe Program:

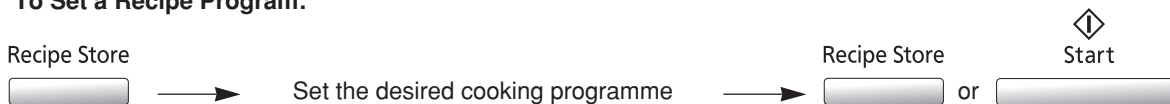

1. Press. The oven is automatically pre-set to memory 1. To select memory 2 press button twice. To select memory 3 press memory button 3 times.

4. Press **Recipe Store** Button. Time of day or colon appears in the display window. If you press **Start** Button, cooking starts and cooking program is set.

To Start Recipe Store Program:



1. Press once to select memory 1. Press twice to select memory 2. Press 3 times to select memory 3. The program appears in the display window.
2. Press. Cooking time in the display begins to count down.

NOTES:

1. Auto Control Functions cannot be programmed into Recipe Store.
2. Convection pre-heat mode cannot be programmed into Recipe Store.
3. Recipe Store can only store 1 stage cooking. It is not possible to store 2 or 3 stage cooking.
4. A new recipe program will cancel the recipe program previously stored.
5. The recipe program will be cancelled if the oven is unplugged.

To Reheat Food Using **Auto Reheat**

Auto Reheat

1 Press

2 Rotate Desired Weight

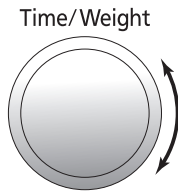

Select the desired weight by turning the **Time/Weight** Dial until the desired food Weight appears in the Display Window. (see below chart)

Food Category Button	Weight			
Auto Reheat	250 g	450 g	650 g	850 g



Start

3 Press

Reheating time appears in the Display Window and begins to count down.

For best results on Auto Reheat, follow these recommendations:

Auto Reheat (250 g - 850 g)

- All foods must be pre-cooked. Suitable for casseroles, plated dinners, soups, stews, pasta dishes (except lasagne), and canned foods.
- **Do not** reheat bread or pastry products; raw; uncooked or frozen foods; or beverages.
- Foods should be reheated from room temperature or refrigerator temperature. Do not reheat frozen foods on this setting.
- Foods should be covered loosely but completely with plastic wrap or a casserole lid which does not snap seal.
- Foods weighting less than 200 g and more than 900 g should be reheated by Micro Power and Time only.
- All foods should have a covered stand time of 3 to 5 minutes at the end of reheating.
- At the end of the cooking time, stir and let stand for 3 to 5 minutes.

INGREDIENT CONVERSION CHART

¼ cup	60 ml	¼ teaspoon	1 ml
⅓ cup	85 ml	½ teaspoon	2 ml
½ cup	125 ml	1 teaspoon	5 ml
⅔ cup	165 ml	2 teaspoons	10 ml
¾ cup	190 ml	3 teaspoons	15 ml
1 cup	250 ml	1 tablespoon	20 ml
1¼ cups	310 ml	1½ tbs	30 ml
1½ cups	375 ml	2 tbs	40 ml
2 cups	500 ml	3 tbs	60 ml
3 cups	750 ml	4 tablespoons	80 ml
3½ cups	875 ml		
4 cups	1 litre		
6 cups	1.5 litre		
8 cups	2 litre		

All recipes are tested using the standard measurements that appear in the above chart.

To Cook Food Using **Auto Cook Menu**

This feature allows you to cook or reheat most of your favourite foods by setting the weight only. The oven determines the Microwave power level and/or Combination setting, then the cooking time automatically. Select the category of food and then just enter the weight. Only enter the weight of the food. Do not include the weight of any added water or the container weight.

1 Press Desired Auto Menu Button

Select and press the appropriate button for the food you are cooking. The menu appears in the Display Window.

2 Rotate Desired Weight

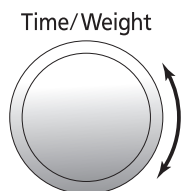

Select the desired weight by turning the **Time/Weight** Dial until the desired food Weight appears in the Display Window. (see below chart)

Food Category Button	Serving / Weight				Accessory and Recommended Container
1. Fresh Vegetables	100 g	200 g	300 g	400 g	Casserole Dish
2. Frozen Vegetables	200 g	300 g	400 g	500 g	Casserole Dish
3. Root Vegetables	250 g	370 g	500 g	900 g	Casserole Dish
4. Rice	100 g	200 g	300 g	400 g	Glass Dish + Casserole Dish
5. Pasta	150 g	250 g	350 g	500 g	Glass Dish + Casserole Dish
6. Fish	100 g	200 g	300 g	400 g	Casserole Dish
7. Congee/Porridge	50 g	100 g	150 g	200 g	Casserole Dish
8. Fresh Pizza	200 g	400 g	600 g	-	Oven Tray
9. Frozen Pizza	200 g	400 g	550 g	-	Oven Tray
10. Baked Potato	300 g	600 g	900 g	-	Glass Dish + Wire Rack (Low)
11. Beef/Lamb	600 g	900 g	1200 g	-	Glass Dish + Wire Rack (Low)
12. Pork	600 g	900 g	1200 g	-	Glass Dish + Wire Rack (Low)
13. Whole Chicken	1200 g	1400 g	1500 g	-	Glass Dish
14. Chicken Pieces	400 g	600 g	800 g	1000 g	Glass Dish + Wire Rack (Low)
15. Meat Skewers	400 g	600 g	800 g	1000 g	Glass Dish + Wire Rack (High)



Start

3 Press

Cooking time appears in the Display Window and begins to count down.

NOTES:

1. If the temperature of the cavity is high, auto cook feature can not be used. Display window will display "HOT". Auto Cook feature can not be used until the "HOT" disappears.
2. When you select an automatic program symbols will appear in the display to show the cooking mode that will be used and the accessories that are needed.

Auto Cook Menu

1. Fresh Vegetables (uses microwave only)

Suitable for cooking a variety of fresh vegetables. Place prepared vegetables into a shallow container. Add 15 ml (1tbsp) of water per 100 g. Cover with pierced cling film or lid. Place the container on the Flat Table on the base of the oven. After cooking, let stand, covered, for 2 to 3 minutes.

2. Frozen Vegetables (uses microwave only)

Suitable for all types of frozen vegetables, like frozen peas, sweetcorn or mixed vegetables. Place prepared vegetables into a container. Add 30 ml (2 tbsp) of water. Cover with pierced cling film or lid. Place the container on the Flat Table on the base of the oven. After cooking, let stand, covered, for 2 to 3 minutes.

3. Root Vegetables (uses microwave only)

Suitable for cooking root vegetables such as potatoes, sweet potatoes, pumpkin, onions, swede, carrots, turnip and beetroot. All vegetables should be trimmed or prepared and cut into even sized pieces. Add 1 tablespoon to $\frac{1}{4}$ cup of water to vegetables if dehydrated or a softer cooked texture is desired. Place into an appropriate size dish and cover securely with plastic wrap or a fitted lid. If desired, butter, herbs etc. may be added but do not add salt until after cooking. Halfway through the cooking time, the oven will 'beep' to prompt you to rearrange the vegetables. At the completion of cooking, stir larger quantities of vegetables. Let stand, covered, for 2 to 3 minutes.

4. Rice (uses microwave only)

Suitable for cooking white rice including short grain, long grain, Jasmine and Basmati. Place washed rice with recommended amount of cold water in a suitable sized dish, with glass dish underneath. Use the following as a guide:

Rice	*Water	Dish Size
100 g	200 ml	3 litre
200 g	300 ml	3 litre
300 g	350 ml	4.5 litre
400 g	450 ml	4.5 litre

*(It may be necessary to adjust the amount of water to your personal preference.)

Rice will boil over if the dish used is too small. Cook rice uncovered. Do not cook in plastic containers unless suitable for high temperature cooking. Stand rice for 5 to 10 minutes after cooking, if necessary. This setting is not suitable for cooking brown rice.

5. Pasta (uses microwave only)

Suitable for cooking a variety of pastas such as spaghetti, fettuccine, tagliatelle, macaroni, penne, spiral and various pasta shapes.

Place the pasta into a suitable sized microwave-safe dish with boiling water, use glass dish under the microwave safe dish. See chart below. Place onto the base of the oven.

Pasta Qty	Boiling Water	Dish Size
150 g	4 cups	3 litre
250 g	6 cups	3.5 litre
350 g	7 cups	4 litre
500 g	8 cups	4 litre

Add 1 tablespoon of oil, if desired, before cooking to prevent the pasta from sticking together. Cover with plastic wrap or a fitting lid. Stir pasta when prompted during cooking. Allow pasta to stand for 5 to 10 minutes after cooking if required then drain.

6. Fish (uses microwave only)

Suitable for cooking whole fish and fish fillets. Select fish suitable for microwave cooking and place in a single layer in a shallow dish, with skin-side down. Add butter, spices, herbs, or lemon juice to flavor. Overlap thin edges of fillets to prevent overcooking. If stuffing whole fish with seasoning, cooking time may need to be extended. Shield the eye and tail area of whole fish with small amounts of aluminum foil to prevent overcooking. Cover dish securely with plastic wrap or fitted lid. Allow large amounts of fish to stand for 3 to 5 minutes after cooking before serving. (thickness of fish should not be more than 3 cm)

7. Congee/Porridge (uses microwave only)

Weight (raw rice)	50 g	100 g	150 g	200 g
Water	300 ml	500 ml	750 ml	1000 ml

Only use microwave safe containers, it is recommended to use a microwave rice cooking container. Soak the rice for about 30 minutes. The proportion between the water and rice is the same as the above form. The total volume should not be over half of the total container. Cover with lid. The oven will 'beep' to prompt you to stir. Wait 5-10 minutes after cooking.

NOTE: Open the container carefully after cooking to prevent scalding due to the hot contents.

8. Fresh Pizza (uses convection and grill)

Use for cooking fresh pizza either purchased or home made. Place assembled pizza on the oven

Auto Menu
(6-10)

tray. Press  3 times to select Fresh Pizza, then select the weight of the pizza you are cooking. Press **Start** to preheat the oven. After preheating, the oven will beep, then place the oven tray with pizza on the low shelf support. Close door and press **Start**.

Auto Cook Menu

9. Frozen Pizza (uses convection and grill)

Use for cooking frozen pizza either purchased or home made. Remove pizza from packaging and place on the oven tray.

Auto Menu
(6-10)

Press  4 times to select Frozen Pizza, then select the weight of the pizza you are cooking. Press **Start** to preheat the oven. After preheating, the oven will beep, then place the oven tray with pizza on the low shelf support. Close door and press **Start**.

10. Baked Potato (uses combination and convection)

Use to cook baked potato/es. Put a light cross-notch on the surface of potato/es with a kitchen knife. Place the prepared potato/es on the low wire rack with glass dish underneath and select the weight. There is no need to preheat oven.

11. Beef/Lamb (uses combination and convection)

Suitable for roasting joints, boned rolled beef/lamb, leg of lamb, lamb rack, beef rump, beef fillet, beef topside. Choose roasting pieces that are even in shape and if boneless have been rolled and tied. Brush with oil/seasonings and place fat side down on the low wire rack using the glass dish. Place the glass dish on the flat base of the microwave. Select auto menu 11 and then select the weight closest to the weight of the item being cooked 600g 900g 1200g and then press **Start**. The oven will beep during cooking to prompt you to turn the meat. Press **Start** to continue cooking once the meat has been turned.

NOTE: Frozen Beef/Lamb should be defrosted before cooking.

12. Pork (uses combination and convection)

Suitable for cooking joints of pork, leg, boned and rolled loin, rib roast and shoulder. Score rind, brush with lemon juice and rub liberally with salt. Place pork on the low wire rack set on the glass dish. Place ensemble onto the base of the oven. Select Pork and then select the closest weight to the Pork being cooked 600g 900g 1200g and press **Start**. During cooking the oven will beep to prompt you to turn the pork, press **Start** to continue cooking once the meat has been turned.

13. Whole Chicken (uses microwave and combination)

Use for roasting whole chickens that are unstuffed.

NOTE: Small sized chickens with stuffing can be cooked using the setting one weight higher than the actual weight. For example, to cook a 1200g chicken that has stuffing, use the 1400g setting even though the total weight of the chicken with stuffing is 1200g. Wash and dry chicken, truss or tie legs. Brush the surface of the skin with butter or oil and sprinkle with seasoning if desired. Place chicken breast side down onto the glass dish, then place the glass dish onto the base of the oven. Select auto menu 13 Whole Chicken, then select the closest weight of the chicken being cooked, 1200g 1400g 1500g and then press **Start**. During cooking the oven will beep to prompt you to turn and baste the chicken, press **Start** to continue cooking once turned.

14. Chicken Pieces (uses combination and grill)

Suitable for most cuts of chicken pieces. Pieces can be plain or marinated. Place the chicken pieces on the low wire rack, place this on the Glass Dish. Place the ensemble onto the base of the oven. Select auto menu 14 Chicken Pieces, then select the closest weight of the chicken pieces being cooked, 400g 600g 800g 1000g and then press **Start**. During cooking the oven will beep to prompt you to turn and baste the chicken, press **Start** to continue cooking once turned.

15. Meat Skewers (uses combination and grill)

Suitable for roasting different kinds of meat skewers. Cut the meat into thin pieces and marinate them with sauce for about 15-20minutes, then string them together. Arrange the skewers on the high wire rack. Place the high wire rack on the Glass Dish and place the ensemble on the base of the oven. Select auto menu 15 Meat Skewers and select the closest weight to the skewers being cooked 400g 600g 800g 1000g, and then press **Start**. During cooking the oven will beep to prompt you to turn the skewers, press **Start** to continue cooking once turned.

NOTE: If using frozen skewers, please defrost before cooking.

To Use Timer Button

To Use as a Kitchen Timer

Press once.



Set desired amount of time
by turning Time/Weight Dial.
(up to 1 hour and 30 minutes)

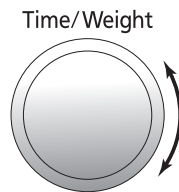

Press Start.

Time will count down
without oven operating.



To Set Standing Time

Press once. Set desired amount of standing time
by turning Time/Weight Dial.
(up to 1 hour and 30 minutes)

Press Start.

Cooking will start.
After cooking, standing
time will count down
without oven operating.

Set the desired
cooking programme.

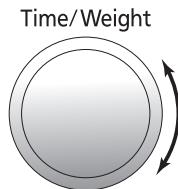

To Set Delay Start

Press once.

Set desired amount of delay time
by turning Time/Weight Dial.
(up to 1 hour and 30 minutes)

Press Start.

Delayed time will count
down. Then cooking
will start.

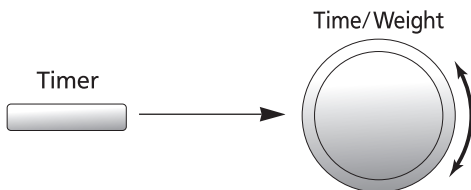

Set the desired
cooking programme.



NOTES:

1. If oven door is opened during the Standing Time, Delay Start or Kitchen Timer, the time in the Display Window will continue to count down.
2. Delay Start/Standing Time cannot be programmed before/after any Auto Control function. This is to prevent the standing temperature of the food from rising before defrosting or cooking begins. A change in the starting temperature could cause inaccurate results and / or food may deteriorate.

Before Requesting Service

THESE THINGS ARE NORMAL

The oven causes interference with my TV.

Some radio and TV interference might occur when you cook with the microwave oven. This interference is similar to the interference caused by small appliances such as mixers, vacuums, hair dryers, etc. It does not indicate a problem with your oven.

Steam accumulates on the oven door and warm air comes from the oven vents.

During cooking, steam and warm air are given off from the food. Most of the steam and warm air are removed from the oven by the air which circulates in the oven cavity. However, some steam will condense on cooler surfaces such as the oven door. This is normal.

I accidentally ran my microwave oven without any food in it.

Running the oven empty for a short time will not damage the oven. However, we do not recommend this to be done.

There are humming and clicking noises from my oven when I cook using Combination.

These noise occur as the oven automatically switches from microwave power to Grill, to create the Combination setting. This is normal.

The oven has an odor and generates smoke when using Convection, Combination and Grill function.

It is essential that your oven is wiped out regularly particularly after cooking by Convection, Combination or Grill. Any fat and grease that builds up on the roof and walls of the oven will begin to smoke if not cleaned.

The fan motor continue operating after cooking is over.

After using the microwave oven, the fan motor will operate for several minutes to cool the electric compenents.

Some smoke may be given off from the cavity when using grill, combination or convection for the first time.

This is caused by a thin film of oil that may be present on the oven cavity from manufacturing, it is recommended to use the convection function at least once with no food to burn off this protective oil film.

Before Requesting Service

PROBLEM	POSSIBLE CAUSE	REMEDY
Oven will not turn on.	The oven is not plugged in securely.	Remove plug from outlet, wait 10 seconds and re-insert.
	Circuit breaker or fuse is tripped or blown.	Contact the specified service centre.
	There is a problem with the outlet.	Plug another appliance into the outlet to check if the outlet is working.
Oven will not start cooking.	The door is not closed completely.	Close the oven door securely.
	Start Button was not pressed after programming.	Press Start Button.
	Another programme has already been entered into the oven.	Press Stop/Reset Button to cancel the previous programme and programme again.
	The programme has not been entered correctly.	Programme again according to the Operating Instructions.
Stop/Reset Button has been pressed accidentally.	Programme over again.	
"HOT" appears in the display window.	The cavity is overheated.	Operate again after it cools down.
"H00" appears in the display window.	The oven is defective.	Contact the specified service centre.
The "LOCK" and "🔒" appears in the display window.	The Child Safety Lock was activated by pressing Start button 3 times.	Deactivated Lock by pressing Stop/Reset button 3 times.
"H97" or "H98" appears in the display window.	The display indicates a problem with microwave generation system.	Contact the specified service centre.
"DEMO MODE PRESS ANY KEY" appears in the display window	The oven is in demonstration mode, microwave doesn't emit.	Press Micro power button once, press Start button 4 times then press Stop/Reset button 4 times.
"COOL" appears in the display window and the post fan operates after using the oven.	The fan rotates to cool the electric components. This is normal.	It is quite safe to take out the food from the oven while the fan operates.

If it seems there is a problem with the oven, contact an authorised Service Centre.

Care of Your Oven

Note: The oven should be cleaned regularly and any food deposits removed.

BEFORE CLEANING:

Remove plug from outlet. If impossible, leave oven door open to prevent oven from accidentally turning on.

Inside of the oven:

Keep the inside of the oven clean. When food splatters or spilled liquids adhere to oven walls, wipe with a damp cloth. Mild detergent may be used if the oven gets very dirty. The use of harsh detergent or abrasives is not recommended.

Outside oven surfaces and back vents.

To prevent overheating caused by blocked vents, clean periodically with damp cloth. To prevent damage to the operating parts inside the oven, water should not be allowed to seep into ventilation openings.

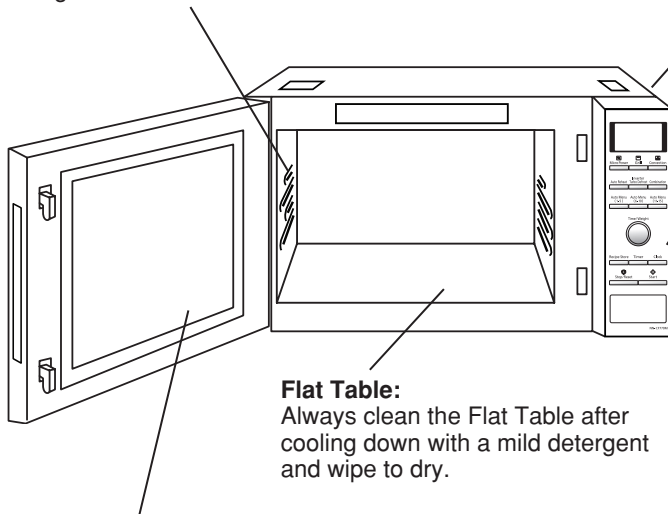

Control Panel:

Do not allow the Control Panel to become wet. Clean with a soft, damp cloth. Do not use detergents, abrasives or spray-on cleaners on the Control Panel. When cleaning the Control Panel, leave oven door open to prevent oven from accidentally turning on. After cleaning press **Stop/Reset** Pad to clear display window.

Flat Table:

Always clean the Flat Table after cooling down with a mild detergent and wipe to dry.

Oven Door:

Wipe with a soft cloth when steam accumulates inside or around the outside of the oven door. This may occur when the microwave oven is operated under high humidity conditions and in no way indicates a malfunction of the unit or of microwave leakage.

After using, clean it with a mild detergent or dishwasher.

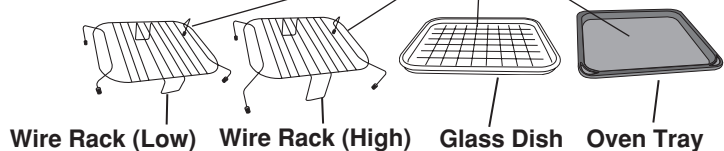

Notes:

1. When using the Convection, Grill or cooking in the Combination mode, some foods may inevitably splatter grease on to the oven walls. If the oven is not cleaned, occasionally it may start to "smoke" during use. These marks will be more difficult to clean later.
2. After Grill, Combination or Convection cooking the ceiling and walls of the oven should be cleaned with a soft cloth squeezed in soapy water. Particular care should be taken to keep the window area clean particularly after cooking by Grill, Combination or Convection. Stubborn spots inside the oven can be removed by using a small amount of microwave oven cleaner sprayed onto a soft damp cloth. Wipe onto problem spots, leave for recommended time and then wipe off. This method can not be used to clean the oven door.
DO NOT SPRAY DIRECTLY INSIDE THE OVEN.
A steam cleaner is not to be used for cleaning.
3. When it becomes necessary to replace the oven light, please consult the service centre specified by Panasonic.
4. The use of harsh/chemical cleaning agents may cause the stainless steel to develop surface rust, this is not a fault and is not covered by warranty.

Technical Specifications

Power Supply:		230 - 240 V 50 Hz
Power Consumption:	Microwave	4.0 A 860 W
	Grill	4.2 A 1,020 W
	Combination	4.2 A 1,020 W
	Convection	6.0 A 1,450 W
Output:	Microwave*	1,000 W
	Grill	1,000 W
	Convection	1,400 W
Power Requirement: (Maximum)		7.3 A 1,650 W
Outside Dimensions:		529 mm (W) x 326 mm (H) x 494 mm (D)
Oven Cavity Dimensions:		354 mm (W) x 205 mm (H) x 343 mm (D)
Cavity Volume:		27 L
Operating Frequency:		2,450 MHz
Uncrated Weight:		Approx. 17.5 kg

Trim Kit

Model Number	NN-TK510CMQP
Outside Dimensions	595 mm (W) x 407 mm (H)
Cabinet Opening	562 mm (W) x 395 mm (H) x 480 mm (D)

* IEC Test Procedure

Specifications subject to change without notice.

As for the voltage requirement, the production month, country and serial number, please refer to the identification plate on the microwave oven.

Panasonic Warranty

1. The product is warranted for 12 months from the date of purchase. Subject to the conditions of this warranty Panasonic or its Authorised Service Centre will perform necessary service on the product without charge for parts or labour if, in the opinion of Panasonic, the product is found to be faulty within the warranty period.
2. This warranty only applies to Panasonic products purchased in Australia and sold by Panasonic Australia or its Authorised Distributors or Dealers and only where the products are used and serviced within Australia or its territories. Warranty cover only applies to service carried out by a Panasonic Authorised Service Centre and only if valid proof of purchase is presented when warranty service is requested.
3. This warranty only applies if the product has been installed and used in accordance with the manufacturer's recommendations (as noted in the operating instructions) under normal use and reasonable care (in the opinion of Panasonic). The warranty covers normal domestic use only and does not cover damage, malfunction or failure resulting from use of incorrect voltages, incorrect installation, accident, misuse, neglect, build-up of dirt or dust, abuse, maladjustment of customer controls, mains supply problems, thunderstorm activity, infestation by insects or vermin, tampering or repair by unauthorised persons (including unauthorised alterations), exposure to abnormally corrosive conditions or any foreign object or matter having entered the product.
4. This warranty does not cover the following items unless the fault or defect existed at the time of purchase:
 - (a) Video or Audio Tapes
 - (b) Video or Audio Heads and Stylii resulting from wear and tear in normal use
 - (c) Shaver Heads or Cutters
 - (d) Cabinet Parts
 - (e) User replaceable Batteries
 - (f) Thermal Paper, Toner/Ink Cartridges, Drums, Developer, Film (Ink/Ribbon), Film Cartridge, Printer Heads
 - (g) Microwave Oven cook plates.
 - (h) Kneader mounting shaft unit (bread bakery)
5. If warranty service is required you should:
 - Telephone Panasonic's Customer Care Centre on 132600 or visit our website and use the Service Centre Locator for the name/address of the nearest Authorised Service Centre.
 - Send or bring the product to a Panasonic Authorised Service Centre together with your proof of purchase receipt as a proof of purchase date. Please note that freight and insurance to and / or from your nearest Authorised Service Centre must be arranged by you.
 - Note that home or pick-up/delivery service is available for the following products in the major metropolitan areas of Australia or the normal operating areas of the nearest Authorised Service Centres:
 - (a) Picture tube (CRT) based Television Receivers (screen sizes greater than 66cm); Rear Projection TV's; Plasma/LCD televisions / displays (screen size greater than 103 cm)
 - (b) Convection/Combination Microwave Ovens
 - (c) Whiteboard (except portable type)
6. The warranties hereby conferred do not extend to, and exclude, any costs associated with the installation, deinstallation or re-installation of a product, including costs related to the mounting, de-mounting or remounting of any screen, (and any other ancillary activities), delivery, handling, freighting, transportation or insurance of the product or any part thereof or replacement of and do not extend to, and exclude, any damage or loss occurring by reason of, during, associated with, or related to such installation, de-installation, re-installation or transit.

Panasonic Authorised Service Centres are located in major metropolitan areas and most regional centres of Australia, however, coverage will vary dependant on product. For advice on exact Authorised Service Centre locations for your product, please telephone our Customer Care Centre on 132600 or visit our website and use the Service Centre Locator.

Unless otherwise specified to the consumer the benefits conferred by this express warranty are additional to all other conditions, warranties, guarantees, rights and remedies expressed or implied by the Trade Practices Act 1974 and similar consumer protection provisions contained in legislation of the States and Territories and all other obligations and liabilities on the part of the manufacturer or supplier and nothing contained herein shall restrict or modify such rights, remedies, obligations or liabilities.

November 2005

THIS WARRANTY CARD AND THE PURCHASE DOCKET (OR SIMILAR PROOF OF PURCHASE) SHOULD BE RETAINED BY THE CUSTOMER AT ALL TIMES

If you require assistance regarding warranty conditions or any other enquiries, please visit the Panasonic Australia website

www.panasonic.com.au or by phone on 132 600



If phoning in, please ensure you have your operating instructions available.

Panasonic Australia Pty. Limited





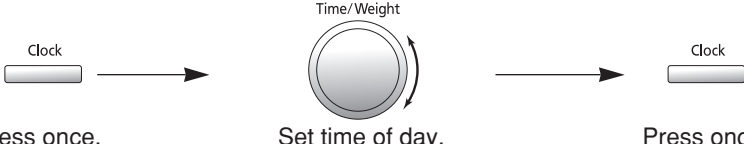
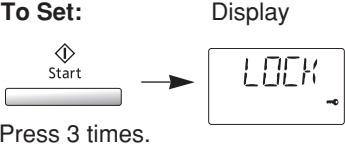
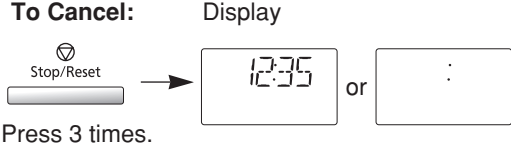
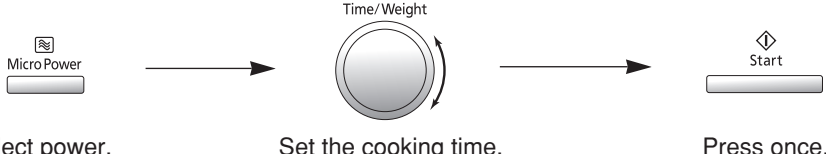
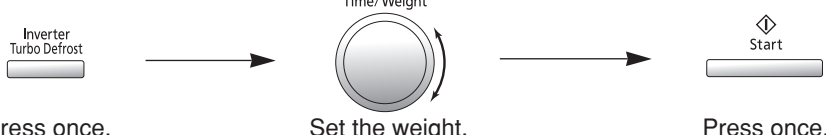

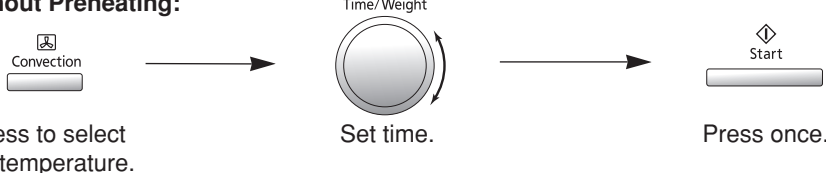
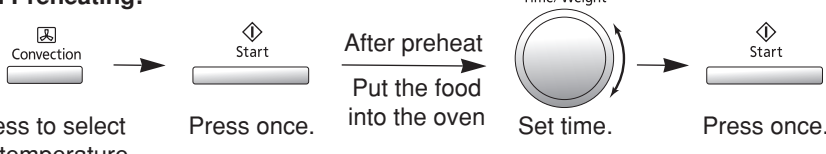
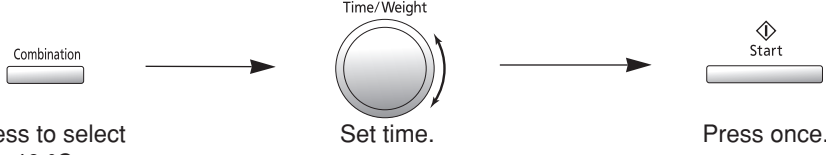









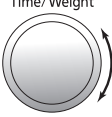

ACN 001 592 187 ABN 83 001 592 187

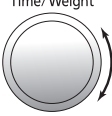
Locked Bag 505, Frenchs Forest, NSW 2086
www.panasonic.com.au

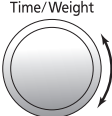
Quick Guide to Operation

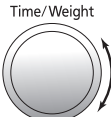
Feature	How to Operate
To Set Clock (page 8)	 <p>Press once. Set time of day. Press once.</p>
To Set / Cancel Child Safety Lock (page 8)	<p>To Set: Display</p>  <p>Press 3 times.</p> <p>To Cancel: Display</p>  <p>Press 3 times.</p>
To Cook / Reheat / Defrost by Micro Power and Time Setting (page 9)	 <p>Select power. Set the cooking time. Press once.</p>
To use Inverter Turbo Defrost Button (page 10)	 <p>Press once. Set the weight. Press once.</p>
To Cook using Grill Button (page 12)	 <p>Select setting. Set the cooking time. Press once.</p>
To Cook using Combination Button (page 13)	 <p>Select setting. Set the cooking time. Press once.</p>
To use Convection (page 14)	<p>Without Preheating:</p>  <p>Press to select the temperature. Set time. Press once.</p>
	<p>With Preheating:</p>  <p>Press to select the temperature. Press once. After preheat Put the food into the oven Set time. Press once.</p>
To use Ferment (page 15)	 <p>Press to select 40 °C. Set time. Press once.</p>

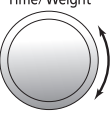
Quick Guide to Operation

Feature	How to Operate
To Cook using the Recipe Store Button <small>(see page 16)</small>	<p>To Set:</p> <p>Recipe Store  → Set the desired cooking programme. →  OR  Press once.</p> <p>To Start:</p> <p> →  Press once.</p>
To Reheat using "Auto Reheat" Button <small>(see page 17)</small>	<p> →  →  Press once. Set the desired weight. Press once.</p>
To Cook using "Auto Cook" Buttons  <small>(see page 18)</small>	<p>eg:  →  →  Press to select the desired category. Set the desired weight. Press once.</p>
To Use as a Kitchen Timer <small>(see page 21)</small>	<p> →  →  Press once. Set the kitchen time. Press once.</p>
To Set Standing Time <small>(see page 21)</small>	<p>Set the desired cooking programme. →  →  →  Press once. Set the standing time. Press once.</p>
To Set Delay Start <small>(see page 21)</small>	<p> →  → Set the desired cooking programme. →  Press once. Set the delay time. Press once.</p>

Microwaves penetrate the surface of the food to a depth of about two to three centimetres and then the heat is gradually conducted in a random pattern. Some parts of food matter cook faster than others. Special microwave techniques are used to promote

fast and even cooking. Some of these techniques are similar to those used in conventional cooking, but because microwaves produce heat very quickly the following techniques are extremely important. It's a must for you to be familiar with the following tips.

Food Characteristics

Size and Quantity

Small portions cook faster than large portions. As you increase the quantity of food you put into the microwave oven, you must also increase your cooking time. The microwave oven has the same power regardless of quantity; thus the power is divided between more items and so it takes longer to cook.

As a general guide, if you double the quantity of food suggested in the recipe, add half the time suggested again.

Liquid Content

Low moisture foods take a shorter time to cook than foods with a lot of moisture.

Shape

Uniform sizes cook more evenly. To compensate for irregular shapes, place thin pieces towards the centre of the dish and thicker pieces towards the outer edge of the dish.

Bone and Fat

Bones conduct heat and cause the meat next to them to be heated more quickly. Large amounts of fat absorb microwave energy and the meat next to these areas may overcook.

Starting Temperature

Food which has been sitting at room temperature takes less time to cook than refrigerated or frozen food.

Density and Composition

Porous, airy foods (cakes and breads) take less time to cook than heavy compacted foods (meat and vegetables). Recipes high in fat and sugar content cook more quickly.

Key to Symbols Used In Recipes

Recipes displaying these symbols may be cooked using these features.

A Auto cook

Techniques for Preparation

Timing

A range of cooking times is given in each recipe for two reasons. First, to allow for the uncontrollable differences in food shapes, starting temperatures and personal preferences. Secondly, these allow for the differences in electrical voltage input which changes during peak load periods. Always remember that it is easier to add time to undercooked food. Once the food is overcooked, nothing can be done. For each recipe, an approximate cooking time is given.

Stirring

Stirring is often necessary during microwave cooking. We have noted when stirring is helpful in the recipes. Always bring the outside edges towards the centre and the centre portions to the outside.

Rearranging or Turning

Some foods should be turned in the container during cooking. For example, because of the different thicknesses in the breast and back sections of poultry, it is a good idea to turn poultry over once to ensure more even cooking. Rearranging or turning over uneven shaped food in the dish should be done as suggested to ensure a satisfactory result. Rearrange small items such as chicken pieces, prawns, hamburger patties, nuts or potatoes. Rearrange pieces from the centre to the edge of the dish.

Cooking in Layers

This microwave oven is not designed to cook more than 1 layer of food. Cooking in 2 layers may not always be successful, it takes longer and may be uneven. You can successfully reheat two dinner plates of food at one time but remember to increase the reheating time and use a microwave warming rack.

Piercing of Foods

Pierce the skin or membrane of foods such as eggs, tomatoes and jacket potatoes when cooked whole in the microwave oven. This allows steam to escape. If the skin has not been pierced, food may burst.

Cured Meats

Cured meats may overcook in some areas due to the high concentration of salts used in the curing process. So take care when cooking different brands of bacon as cooking times may vary slightly.

Techniques for Preparation

Covering

Covering food minimizes the microwave cooking time.

Because microwave cooking is done with time and not direct heat, the rate of evaporation cannot be easily controlled. However, this can be corrected by using different materials to cover dishes. Plastic wrap is the best substitute for a lid as it creates a tighter seal and so it retains more heat and steam. Wax paper and paper towels hold the heat in but not the steam. These materials also prevent splattering. Use a paper towel, wax paper or no cover when steam is not needed for tenderising.

Browning

Meats and poultry, when cooked longer than 10 to 15 minutes, will brown from their own fat. Foods cooked for shorter periods of time can be aided with the help of a browning sauce, worcestershire sauce or soy sauce. Simply brush one of these sauces over meat or poultry before cooking. Baked goods do not need long cooking times and therefore, do not brown. When cakes or cupcakes are iced, no one will notice the visual difference. For cakes or cupcakes, brown sugar can be used in the recipe in place of caster sugar or the surface can be sprinkled with dark spices before baking.

Standing Time

The moisture molecules continue to vibrate in the food when the microwave oven has turned itself off. After all, the molecules were vibrating at 2,450,000,000 times per second during cooking. So cooking continues even after the food is no longer being exposed to the microwaves whether in or outside your microwave oven.

Standing time refers to the time it takes (after the microwave time is completed) to allow the interior of the food to finish cooking.

The amount of standing time varies with the size and density of the food. In meat cookery, the internal temperature will rise between 5°C and 10°C if allowed to stand covered for ten to fifteen minutes. Rice and vegetables need shorter standing time, but this time is necessary to allow foods to complete cooking in the centre without overcooking on the edges.

The power level used in microwave cooking also determines the standing time. For example, when using a lower power level the standing time is shorter because of a lower concentration of heat in the food. Foods should always be kept covered while standing in order to retain the heat. If a longer standing time is required (while you cook another food to serve with the first, for instance), cover with aluminum foil.

Converting Your Favourite Conventional Recipes for Microwave Cooking

When adapting conventional recipes for microwave cooking, times are reduced considerably.

For example, A chicken which takes 1 hour to cook in a moderate oven will take 15 to 20 minutes on Medium Power in your microwave oven.

Use similar microwave recipes to help you adapt conventional recipes. Remember, it is always best to undercook a recipe and then add an extra minute or two to finish it off.

Here are some other tips that may help:

- Reduce liquids in a conventional recipe by one half to two thirds, e.g. 1 cup (250 ml) should be reduced to ½ cup (125 ml).
- Add more thickening such as flour or cornflour to sauces and gravies if you do not reduce the liquid.
- Reduce seasonings slightly in a recipe where ingredients do not have time to simmer by microwave.
- Do not salt meats, poultry or vegetables before cooking; otherwise, they will toughen and dry out.
- If one ingredient takes longer to cook than the others, pre-cook it in the microwave oven first. Onion, celery and potato are examples.
- When cooking meat or vegetables, omit any oil or fat that would have been used in a conventional recipe for browning.
- Reduce leavening agents for cakes by one quarter and increase liquids by one quarter.
- Biscuits require a stiff dough. Increase flour by about 20 percent. Substitute brown sugar for white sugar and use biscuit recipes that have dark spices or require icing. Because of the short cooking time, biscuits don't have time to brown. Chill dough for half an hour before baking. This produces a crisper biscuit. Bake biscuits on a glass tray lined with greaseproof paper.
- Since microwaves penetrate foods about two centimetres from the top, bottom and sides, mixtures in round shapes and rings cook more evenly. Corners receive more energy and may overcook.
- Items with a lot of water, such as rice and pasta, cook in about the same time as they would on a conventional stove. (Refer to **Rice** and **Pasta** chapter.)

Select recipes that convert easily to microwave cooking such as casseroles, stews, baked chicken, fish and vegetable dishes. The results from foods such as grilled meats, cooked souffles or two-crust pies could be less than satisfactory. Never attempt to deep fry in your microwave oven.

Menu Planning for Microwave Cooking

How to Keep Everything Hot at The Same Time

Plan your meals so that the food will not all need last minute cooking or attention at the same time. The special features of microwave cookery make it easy to serve meals with everything piping hot. Cooking of some foods may be interrupted while you start others, without harming the nutritional value or flavour of either.

A recipe which requires standing time can be microwaved first and another food cooked while it stands. Dishes prepared in advance can be reheated briefly before serving.

It does take some experience and time to cook with confidence. Microwaves are fast so you will have to do some experimenting. You might find you will use your conventional range in conjunction with your microwave oven. For example, while cooking the roast in the microwave oven, you can be cooking the vegetables and gravy on the range top. This can also be done the other way around. Prepare your meals as follows.

1. Firstly, cook the most dense item (roast or casserole). Drain and retain meat juice from joints then cover with foil.
2. Cook the potatoes, rice or pasta.
3. Cover with foil for standing.
4. Cook greens and other vegetables.
5. Cover with foil for standing.
6. Cook the gravy with the retained meat juices, stock and thickening.
7. Carve the roast and serve the vegetables and gravy.

While you are learning to plan meals, you may get a bit behind time. Don't worry. Dinner servings may be reheated on Medium-High, for 1 to 2 minutes per serving.

If you prefer not to use foil, cover food with saucepan lids. A metal lid will retain the heat for at least 15 minutes.

Meanwhile, how can you cook all the vegetables at the same time? Simply place potatoes and pumpkin in one dish and less dense vegetables such as broccoli, cabbage, cauliflower, beans and peas in another. Sprinkle greens with water. Cover with a lid or plastic wrap. Cook on Medium-High for cooking times refer to vegetable cooking chart on page 20. Fresh and frozen vegetables can be mixed on a vegetable platter, but remember frozen vegetables are not as dense as fresh vegetables, as they have been blanched before freezing.

If vegetables are cut to a similar size, they can be cooked in separate ramekins or small dishes at the same time.

Increasing & Decreasing Recipes

Increasing

- To increase a recipe from 4 to 6 servings, increase each ingredient listed by half.
- To increase a recipe from 4 to 8 servings, double each ingredient listed.
- For larger quantities of a recipe, a large dish should be used. Make sure that the dish is deep enough to prevent the recipe from boiling over during cooking.
- Make sure to cover, stir or rearrange food as directed in the recipe and always check the food during cooking.
- Increase standing times by 5 minutes per 500g.
- Use the same Power Level recommended in the original recipe.
- Increase the cooking times by: $\frac{1}{3}$ of original cooking time for 6 servings; and an extra $\frac{1}{2}$ of original cooking time for 8 servings.

Decreasing

- To decrease a recipe from 4 to 2 servings, decrease each ingredient listed by half.
- For small quantities, a small dish should be used. Make sure that the dish is large enough to prevent the recipe from boiling over during cooking.
- Use the same Power Level recommended in the original recipe.
- Decrease the cooking times by $\frac{1}{2}$ to $\frac{2}{3}$ of the original cooking time.

Cooking for One

- To decrease a recipe from 4 to 1 serving, quarter each ingredient listed.
- A smaller dish should be used, making sure that the dish is still large enough to prevent the recipe from boiling over.
- Use the same Power Level recommended in the original recipe.
- Quarter the original cooking times, then add extra time, if needed.
- Make sure to cover, stir or rearrange food as directed in original recipe and always check the food during cooking.

Converting Recipes from Other Sources

When the recipe is written with a wattage different than your oven, adjust the cooking time by approximately 10% per 100 watts, e.g. 6 minutes would be adjusted by 36 seconds. Alternately, adjust the power level by one level. If your wattage is higher than the recipe: (1) Adjust time downward or (2) Adjust power level downward. If your wattage is lower than the recipe: (1) adjust time upward or (2) adjust power level upward (when possible).

Reheating

One of the most common uses for a microwave oven is to reheat food. Your Panasonic microwave allows you to either reheat by placing food into the oven and you choose the micro power level and length of heating time or you may reheat automatically by using the AUTO REHEAT buttons on your microwave. Following are some directions for reheating pre-cooked foods from either frozen refrigerator temperature or room temperature.

General rules for reheating foods by Micro Power

- Many convenience foods contain heating instructions on the packaging. It is best to follow these instructions, being sure to check the wattage of the oven they used and adjust the cooking time if necessary (decrease cooking time by 10% for every 100watts more powerful your oven is)
- If package directions are not available, follow the recommendations in the charts on the following pages.
- All foods must be pre-cooked; raw foods will not cook through during reheating times and if consumed may cause illness.
- Do not reheat in foil containers, cans or plastic containers as incorrect heating times will result. Place foods into microwave safe bowls or onto dinner-plates before heating.
- Most foods can be heated on High but consider if the food is delicate in structure like baked custard or you have a large quantity, a lower power level for slightly longer may be gentler.
- Cover foods with plastic wrap if you require a steamed effect or leave uncovered for a dryer surface e.g. Crumbed foods
- Stir or re-arrange foods during heating as this will help food heat evenly. Stir after heating and let stand for 2 to 3 minutes. Check temperatures before adding extra heating time and ensure food is hot. If food is not heated enough, consumption may cause illness.

Reheating by Auto Cook (250 g - 850 g)

- Foods weighting less than 200 g and more than 900 g should be heated by micro power and time.
- Auto Cook has 2 settings one for heating frozen foods and one for heating foods from refrigerator or room temperature.
- Suitable foods include casseroles, plated dinners, soups, stews, pasta dishes. (except lasagne) and canned foods.
- Do not reheat bread or pastry items, raw or uncooked foods or beverages.
- Cover foods loosely with plastic wrap or a lid, which does not snap seal.
- At the end of cooking time, stir the food, check it is hot and allow standing 2 to 3 minutes.

To Operate: Press  Auto Reheat, select the weight by using **Time/Weight** Dial, then press **Start**.

Caution:

Pastry items which have a filling that is high in fat., sugar or moisture will become hotter in the centre and the pastry may only feel warm. Ensure you allow it to stand for several minutes before eating.

Reheating by Micro Power - Frozen Pre-cooked Foods

FROZEN ITEM (Pre-cooked)	POWER	TIME (in minutes)	SPECIAL INSTRUCTIONS
BREAD & BAKED PRODUCT			
Bread 1 slice	Medium-High	10 - 15 sec	Do not let bread get hot, or it will become rubbery and dry out. Remove whole loaf from original wrapper. Place on paper towel to absorb moisture.
1 loaf	Medium-High	1 - 3	
6 rolls	Medium	1 - 2	
Cheesecake (450g)	Defrost	5 - 7	Remove from container. Defrost on plate.
Muffins - 4 (400 g)	Medium-High	1 ¹ / ₂ - 2	Place onto paper towel lined plate.
Scones - 6 (400 g)	Low	1 ¹ / ₂ - 2	Defrost on paper lined plate. Stand 2 minutes.
PIES			
Fruit Pie (600 g)	Defrost then Medium-High	5 - 7 5 - 7	Remove from foil container and place uncovered into a pie dish.
Meat Pie (175g)	Medium-High	4 - 5	Place onto paper towel lined plate.
Pizza (350 g)	High	5 - 7	Remove from package and place onto paper towel or follow manufacturer's instructions.
FROZEN MEAL			
Fish in Sauce (200 g)	Medium	5 - 8	Pierce corner of bag. Heat on a plate.
Frozen Casserole (500g)	High	9 - 11	Pierce pouch. Heat on a plate or bowl.
Lasagne (500 g)	Medium-High	11 - 13	Remove from foil container, place into serving dish.
Plated style dinner (320 g)	Medium	8 - 10	Remove foil cover and replace with plastic wrap.
Vegetables & Sauce (in the bag) (500 g)	Medium-High	10 - 12	Pierce corner of bag. Heat on a plate.
MISCELLANEOUS			
Chicken Pieces (500 g)	Medium-High	8 - 10	Place onto paper towel lined plate.
Chicken Nuggets	Medium-High	2 - 4	Place on paper towel lined plate.
Croissants - 4 (200 g)	Defrost	1 - 1 ¹ / ₂	Place onto paper towel lined plate.
Fish Fingers - 8 (200 g)	Defrost then High	2 - 4 2 - 3	Place onto paper towel lined plate.
Sausage Rolls (225 g)	Medium	2 - 3	Place onto paper towel lined plate.

IMPORTANT POINTS TO CONSIDER WHEN REHEATING COLD FOODS

STARTING TEMPERATURE —

Foods taken from the refrigerator will take longer to reheat than foods from room temperature.

Quantity —

One serving heats faster than several servings. When heating large quantities, stir food to ensure even heating. It is quicker to heat individual plates of food than large quantities in a casserole dish.

Plated Dinners —

Arrange foods with the most dense items towards the outside of the plate. Cover meats with sauces/gravies if desired, spread out mashed potatoes or rice so it heats more evenly. When assembling plates of leftover foods, use foods which have a similar starting temperature.

Covering Foods —

Most foods need to be covered with one sheet of absorbent paper towel to hold in the heat and prevent splattering without steaming. When more moisture is desired, cover with plastic wrap.

Heating —

Reheating is usually done on High, however, if food has a more delicate texture, like a baked custard, a lower power setting should be used. Medium for a little longer will be gentler on the food. An average plate of food would generally take 1 to 3 minutes to heat depending on the density of the food. Place it in for the minimum time and add extra heating time if required.

Ensure food is hot by feeling the bottom of the plate in the centre. If the plate is cool, food may be warm but will lose heat quickly as the plate will absorb the heat and taste cold when served.

If food is not heated enough, consumption may cause illness.

Elevation —

Elevate pastries and breads on a small plastic rack with paper towel under the food to prevent it from becoming soggy.

IMPORTANT POINTS TO CONSIDER WHEN REHEATING FOODS FROM THE FREEZER

VOLUME —

The greater the volume and the more dense the item, the longer it takes to reheat. E.g. frozen cake will take less time than frozen casserole.

LARGE VOLUME —

Large, dense, frozen precooked foods are best thawed on defrost until icy in the centre then heated on Medium-High. This prevents overcooking of the edges. Stirring is often needed to distribute heat evenly.

Commercial frozen foods —

These foods should be removed from their foil containers if possible and placed into suitable microwave safe containers. If a foil container is used in the microwave oven it shouldn't be more than 4 cm high and must not touch the interior of the microwave oven. Remove the cover from the tray and replace with paper towel or plastic wrap to prevent splattering.

Foods to be served at room temperature —

For best results, defrost for a short time and allow to stand to complete thawing, e.g. frozen cake.

Vacuum sealed pouches —

Pierce pouches, bags before heating to allow steam to escape. This prevents bursting.

Containers —

Use dishes about the same volume of the food or slightly larger to allow for stirring. Remove or release snap seal lids otherwise they will pop during heating and may disfigure.

Pies and pastries —

Pies and pastries that contain raw pastry and filling cannot be cooked in the microwave oven. Pre-cooked products can be thawed and heated. Place them on a sheet of paper towel and elevate on plastic rack for best results. For added crispness place under the grill or in a hot oven for few minutes. Pastry items can become tough and rubbery if overheated, remember to allow 5 minutes standing then test before adding extra heating time.

PUMPKIN SOUP A

Serves: 4

Ingredients:

1 kg	pumpkin, peeled and chopped
1	onion, diced
2 cups	chicken stock
1 teaspoon	curry powder
	pepper

Method:

Place pumpkin, onion and curry powder in a 2-litre casserole dish. Cover and cook on High for 12 minutes. Add chicken stock and pepper. Cook on High for 10 minutes. Cool slightly. Purée pumpkin and liquid in a blender or food processor. Pour into individual serving dishes and garnish with chives.

SHORT AND LONG SOUP

Serves: 4

Ingredients:

200 g	fresh singapore noodles
12 (200 g)	frozen mini dim sims
4	green onions, sliced
1 litre	chicken stock
1 teaspoon	crushed garlic
½ teaspoon	chopped fresh ginger
2 tablespoons	soy sauce
1	chicken breast, cooked and sliced
4	baby bok choy, quartered
1 cup	bean sprouts
2 tablespoons	dried onion (optional)

Method:

Place all ingredients except bok choy and bean sprouts in a 4 litre casserole dish and cook on High for 10 minutes. Add bok choy and cook on High for 2 minutes. Serve in individual bowls topped with bean sprouts and onion.

Hints:

To cook 1 double chicken breast. Place onto a dinner plate. Cover and cook on Medium-High for 8 to 10 minutes.

Hints:

To reheat a single portion of soup. Place in a microwave safe dish and cook on Medium-High for 2 to 3 minutes.

PEA AND HAM SOUP

Serves: 6

Ingredients:

2½ cups	green split peas
850 g	smoked ham hock
1 medium	onion, chopped
1 tablespoon	fresh thyme leaves
1	bay leaf
6 cups	chicken stock
½ cup	frozen peas

Method:

Wash split peas and place in a 2-litre capacity bowl with 1-litre of water. Cover and allow soaking for 8 hours or overnight. Remove rind from ham hock and discard. Cut meat away from the bone and roughly chop. Reserve bone. Drain peas and place into a 5-litre capacity microwave safe dish. Add ham bone, chopped ham, onion, thyme, bay leaf and chicken stock. Cook uncovered on High for 15 minutes. Reduce power to Medium and cook for 15 minutes. Skim top of soup and cook on Medium for a further 30 minutes. Remove ham bone and bay leaf and stir in frozen peas. Cook on Medium for 10 minutes. Blend half the soup and return to the bowl, stirring through the remaining soup. Serve hot with crusty bread.

Tip:

Substitute 500 g bacon bones and 250 g of diced bacon rashers for the ham hock. Do not add salt when cooking lentils or pulses, as they will toughen. Add salt after cooking if desired.

POTATO AND LEEK SOUP A

Serves: 4 to 6

Ingredients:

1 kg	potatoes, peeled and diced
2 medium	thinly sliced leeks
2 teaspoons	fresh thyme
	pepper
3 cups	chicken stock
150 ml	cream

Method:

Place potatoes, leeks, thyme and pepper in a 4-litre casserole dish. Cover and cook on High for 8 minutes. Stir in chicken stock. Cover and cook on High for 14 to 16 minutes. Purée soup mixture. Add cream, stir and serve hot or cold in individual bowls.

CHICKEN AND PRAWN LAKSA

Serves: 4

Ingredients:**Soup:**

2 tablespoons laksa paste
 400 ml coconut milk
 1 litre chicken stock
 1 tablespoon soy sauce
 fresh ground black pepper

Laksa:

250 g rice noodles
 8 cups boiling water
 1 bunch coriander leaves chopped
 4 small red chillies, seeds removed and finely chopped
 1/2 cup bean sprouts
 4 lime wedges
 1 tablespoon peanut oil
 400 g cooked chicken tenderloins, sliced
 12 green king prawns, peeled

Method:**Soup:**

Place the laksa paste, coconut milk, stock, soy sauce and pepper into a 3-litre dish and cook covered on High for 8 to 10 minutes.

Laksa:

Place the noodles and water in a 4 litre dish. Cover and cook on High for 2 to 3 minutes, stirring halfway through. Drain well and divide between 4 deep bowls. Place the coriander, chillies, bean sprouts and lime on top. Place the peanut oil and prawns in a 1-litre dish and cook on Medium-High for 3 to 5 minutes, stirring halfway through. Add the chicken and prawns to each individual bowl and set aside.

To serve:

Heat soup on High for 2 minutes. Pour the hot soup over the ingredients in the 4 bowls and serve.

ZUCCHINI SLICE

Serves: 4 to 6

Ingredients:

4 rashers bacon, diced
 1 onion, diced
 2 cups grated zucchini
 2 cups grated carrot
 1 cup grated tasty cheese
 1 cup self raising flour
 5 eggs, lightly beaten
 125 ml vegetable oil
 1 tablespoon fresh chopped parsley
 salt and pepper

Method:

Lightly grease a 25 cm square microwave safe dish. Place bacon and onion in a 2-litre casserole dish and cook on High for 2 to 3 minutes. Allow to cool slightly. Stir in zucchini, carrot and cheese and flour. In a 1-litre bowl whisk together eggs, oil and parsley. Add to bacon mixture season with salt and pepper and stir until combined. Pour into prepared dish. Cook on Medium for 16 to 18 minutes.

NACHOS SUPREME

Serves: 4 to 6

Ingredients:

500 g topside mince
 35 g Taco seasoning mix
 1/3 cup tomato paste
 1 teaspoon Mexican chilli powder

310 g

can red kidney beans, mashed in liquid

180 g

corn chips

1

avocado

1/2 cup

sour cream

1/2 cup

grated cheese

paprika

Method:

Place meat and onion in a 2-litre dish. Cook on Medium-High for 6 minutes, stirring halfway through cooking. Mix with fork, breaking up any large pieces of meat. Add taco mix, tomato paste, chilli powder and kidney beans. Cook on Medium-High for further 10 minutes, stirring halfway through cooking. Place corn chips in a 3-litre microwave suitable serving dish. Pile meat sauce in the centre. In a small bowl, mash avocado and mix in sour cream. Spoon this mixture over meat sauce and top with grated cheese. Sprinkle with paprika. Heat on Medium-High for 3 to 4 minutes.

NUTS AND BOLTS

Serves: 6 to 8

Ingredients:

80 g butter
 2 teaspoons curry powder
 2 tablespoons worcestershire sauce
 1/2 teaspoon salt
 1/4 teaspoon garlic powder
 100 g mixed rice crackers
 100 g fried noodles
 200 g salted peanuts
 125 g pretzel sticks
 1/2 cup Nutri-Grain

Method:

Place butter, curry, worcestershire sauce, salt and garlic powder in a 3-litre casserole dish. Cook on High for 1 to 2 minutes. Add remaining ingredients, mix well and cook on High for 4 to 5 minutes. Stir twice during cooking. Allow to cool. Place in a bowl and serve with drinks. Store in an airtight container once cool.

PRAWN & SALMON FILO PARCELS

Serves: 4

Dish: greased baking sheet 32 x 23 cm (12 1/2 x 9 inches)
 Oven Accessory: low wire rack

Ingredients:

250 g tail end of salmon, boned, skinned, and cut into bite-sized pieces.
 125 g cooked peeled prawns piece of 1/2
 lemon salt & black pepper
 125 g filo pastry
 50 g butter, melted

Method:

Combine salmon and prawns. Sprinkle with lemon juice and season to taste. Preheat the oven empty on **CONVECTION 190 °C**. Cut the filo pastry into 8 squares measuring 18cm (7 in). Brush 2 squares with the melted butter, covering the remaining squares with a damp tea towel. Place of the salmon & prawn mixture in the middle of one buttered filo square. Fold 2 sides of the filo to form a rectangle. Fold one of the open ends over the filling and the other one underneath. Place this parcel on the second buttered square and draw up the edges and seal the parcel. Repeat steps 4-7 three more times. Place parcels on baking sheet, brush with melted butter and place on low wire rack. Cook on **CONVECTION 190 °C** for 20 mins. or until crisp and golden.

Cooking Fish and Shellfish by Micro power

Clean fish before starting the recipe. Arrange fish in a single layer, overlap thin fillet ends to prevent overcooking. Prawns and scallops should be placed in a single layer.

Cover dish with plastic wrap. Cook on the power level and the minimum time recommended in the chart below. Halfway through cooking rearrange or stir prawns, fish fillets or scallops.

Cooking Fish and Shellfish using Micro power

FISH OR SHELLFISH	AMOUNT	POWER	APPROX. COOKING TIME (in minutes)
Fish Fillets	500 g	Medium-Low	10 to 12
Scallops (sea)	500 g	Medium-Low	6 to 8
Green Prawns medium size (shelled and cleaned)	500 g	Medium-Low	7 to 9
Whole Fish (stuffed or unstuffed)	500 g to 600 g	Medium-Low	9 to 11

Directions for cooking fish by Auto Cook

- **Minimum weight 100 g / Maximum weight 400 g**
- Suitable for cooking whole fish and fish fillets.
- Select fish suitable for microwave cooking and place in a single layer in a shallow dish, with skin-side down.
- Add butter, spices, herbs, or lemon juice to flavour.
- Overlap thin edges of fillets to prevent overcooking.
- Shield the eye and tail area of whole fish with small amounts of aluminum foil to prevent overcooking.
- Cover dish with plastic wrap.
- Allow large amounts of fish to stand for 3 to 5 minutes after cooking before serving.

To Operate for Auto Cook:

Auto Menu
(6-10)

Press  once to select Fish, set the desired weight by turning the **Time/Weight** Dial, then press **Start**.

SPICED WHOLE BREAM

Serves: 2

Ingredients:

2 x 400 g	whole bream
1	clove garlic
3 stalks	coriander
1	red birds eye chilli
1 tablespoon	freshly chopped ginger
1 tablespoon	lime juice
2 teaspoons	fish sauce
2 teaspoons	brown sugar
2	green onions, sliced

Method:

Clean and scale fish, set aside. Process remaining ingredients in a food processor to form a paste. Rub the spice paste into the fish and place them in a microwave safe dish. Cook on Medium-Low for 12 to 15 minutes.

GARLIC & CHILLI PRAWNS

Serves: 4

Ingredients:

1 kg	medium uncooked king prawns
1	small red onion, thinly sliced
40 g	butter
3	garlic cloves, crushed
2	fresh bird's eye chillies, deseeded & finely chopped
1/2	small red capsicum, finely sliced
100 g	snow peas, trimmed
1 tablespoon	lemon juice
80 ml	thickened cream
1/4 cup	coriander leaves, chopped
	Cooked jasmine rice, to serve

Method:

Peel and de-vein prawns leaving tails in tact, set aside. Place onion, butter, garlic and chilli into a 3-litre microwave safe dish. Cook on High for 4 minutes, stir halfway through cooking. Add prawns and mix to combine. Cook on Medium-High for 3 minutes. Stir in capsicum and snow peas, cover and cook on Medium-High for a further 3 minutes. Stir through lemon juice, cream and coriander, season and cook on High for 1 minute. Serve immediately with cooked rice.

SALMON STEAKS WITH LIME BUTTER

Serves: 4

Ingredients:

60 g	butter
1	clove garlic, crushed
1 teaspoon	grated fresh ginger
1 teaspoon	grated lime rind
2 tablespoons	lime juice
1/2 teaspoon	sugar
500 g	salmon, steaks

Method:

Place butter, garlic, ginger, lime rind, juice and sugar in a shallow dish. Cook on Medium-High for 1 to 2 minutes. Stir halfway through cooking. Add salmon steaks and coat with sauce. Cover and cook on Medium for 5 to 7 minutes. Stand for 2 to 3 minutes before serving.

TOMATO BASIL MUSSELS

Serves: 4

Ingredients:

1 kg	fresh mussels
¼ cup	water
1 tablespoon	olive oil
1	leek, sliced
1	clove garlic, crushed
440 g	can tomato pieces
1 tablespoon	tomato paste
½ teaspoon	oregano
2 tablespoons	chopped fresh basil
	freshly ground black pepper

Method:

Place mussels and water into a bowl. Cover and cook on Medium-High for 4 to 6 minutes. Set aside. Place oil, leeks and garlic into a 3-litre dish. Cook on High for 2 minutes. Stir well. Add tomatoes, tomato paste, oregano, basil and pepper. Mix well. Cook on High for 3 to 4 minutes. Add mussels. Cover and cook on High for 2 to 3 minutes. Serve immediately.

LEMON PEPPER FISH [A]

Serves: 2

Ingredients:

350 g	fish fillets
¼ cup	lemon juice
1 teaspoon	cracked black pepper

Method:

Place fish, lemon juice and cracked black pepper in a 1-litre casserole dish. Cook on Medium for 4 to 6 minutes. Let stand for 3 minutes before serving.

SALMON WITH MANGO SALSA

Serves: 4

Dish: shallow dish

Oven Accessory: Glass Dish

Ingredients:

4 salmon	fillets each 100-150 g
----------	------------------------

marinade:

3 tablespoons	white wine	1 garlic clove, crushed
2.5 cm	fresh root ginger, finely grated	

mango salsa:

2 red chillies, seeds removed, thinly sliced
100 g peeled, cooked prawns
4 spring onions, thinly sliced
1 small garlic clove, finely chopped
1 ripe but firm avocado, peeled and chopped
½ ripe mango, peeled and chopped
1 lime, juice of

Method:

Mix the marinade ingredients together. Pour marinade over salmon in dish and leave to marinate for 2-3 hrs in the fridge. Mix all the salsa ingredients together and chill in fridge. Place the salmon on the Glass Dish directly on base of oven. Pour over half the marinade and cook salmon on **MEDIUM MICROWAVE** for 3 mins. Pour the remaining marinade over the salmon and continue cooking on **MEDIUM MICROWAVE** for 3-4 mins. Serve salmon with the salsa.

NOTE: For 2 fillets the marinade and salsa quantities should be halved and total cooking time on **MEDIUM MICROWAVE** should be reduced to 4-5 mins.

*Alternatively the Salmon may be grilled. Place salmon skin side up on the Oven Tray in the upper position and cook on GRILL 1 for 10 mins. Turn halfway.

CREAMY TUNA PENNE [A]

Serves: 4

Ingredients:

250 g	penne
5 cups	boiling water
1	medium onion, diced
2 cups	mixed sliced vegetables
240 g	can tuna, reserve liquid
2 tablespoons	Parmesan cheese
1 tablespoon	dried thyme
1 tablespoon	lemon juice
½ cup	sour cream
	cracked black pepper

Method:

Place Penne and water in a large casserole dish. Cook on High for 10 to 14 minutes.

To Cook by Auto Cook:Auto Menu
(1-5)

Press 5 times to select Pasta, rotate the **Time/Weight** Dial to select 250 g, then press **Start**. Stand, covered, for 2 minutes. Drain. Place onion in 4-cup jug. Cook on High for 50 to 60 seconds. Add mixed vegetables. Cook on High for 2 to 3 minutes. Stir in tuna and liquid, add remaining ingredients and stir until combined. Cook on Medium-High for 2 to 3 minutes. Place pasta in a serving bowl and pour over sauce to serve.

SEAFOOD MARINARA

Serves: 4

Ingredients:

750 g	marinara mix
2 tablespoons	butter
1	clove garlic, crushed
410 g	tomato puree
1 tablespoon	tomato paste
¼ cup	white wine
¼ cup	fresh basil leaves, chopped
	pepper
	chopped parsley

Method:

Place marinara mix into a 2-litre casserole dish. Set aside. Place butter and garlic in 1-litre casserole dish. Cook on Medium-High for 1 minute. Add remaining ingredients (except seafood), to dish and cook on High for 5 minutes. Add seafood. Cook on Medium for 8 to 10 minutes. Stand for 5 minutes. Serve with salad and pasta.

GARLIC PRAWNS

Serves: 2

Ingredients:

60 g	butter
2 cloves	garlic, crushed
1 tablespoon	lemon juice
1 tablespoon	chopped parsley
500 g	peeled green prawns

Method:

Place butter and garlic in a 1-litre dish and cook on High for 30 to 50 seconds. Add lemon juice, parsley and prawns. Cook on Medium for 5 to 7 minutes, stirring halfway through cooking. Serve in individual ramekins.

OYSTER SOUP

Serves: 4 to 6

Ingredients:

30 g butter
2 tablespoons flour
2 cups chicken stock
½ cup cream
20 bottled oysters, drained
salt and white pepper
snipped chives to garnish

Method:

Place butter in 2-litre casserole dish and cook on High for 1 minute. Add flour, stir well and cook on High for 30 seconds. Gradually add stock, stirring continuously. Cook on High for 5 to 7 minutes, stirring halfway through cooking. Add cream, oysters, salt and pepper. Cook on Medium-High for 1 to 2 minutes. Spoon into individual dishes and garnish with chives.

BOUILLABAISSE

Serves: 4 to 6

Ingredients:

2 tablespoons olive oil
2 onions, sliced
1 large leek, sliced
4 cloves garlic, crushed
425 g tomato pieces
½ cup tomato paste
4 cups hot fish stock
⅓ cup dry white wine
1 tablespoon fresh thyme leaves
½ teaspoon saffron powder
1 teaspoon chilli powder
freshly ground black pepper
salt
500 g firm fish fillets, chopped
500 g green prawn meat, de-veined

Method:

Place oil, onions, leek and garlic in a 4 litre dish. Cover and cook on High for 6 to 8 minutes. Stir halfway through cooking. Add tomatoes, tomato paste, fish stock, wine, thyme, saffron, and chilli powder. Season with salt and pepper. Cook on High for 12 minutes. Add fish fillets and prawns. Cook on High for 6 to 8 minutes or until seafood is cooked. Serve garnished with fresh thyme.

Noise

During cooking, popping sounds may be heard. This is due to moisture trapped between the flesh, particularly with oily fish such as salmon and mackerel. This can be minimised when cooking if the skin and flesh is pierced several times with a skewer.

MALAY COCONUT FISH

Serves: 4

Ingredients:

400 ml coconut milk
1 tablespoon chilli sauce
1 lime zested
5 cm piece peeled ginger, finely chopped
1 tablespoon garam masala
1 tablespoon fish sauce
2 tablespoons brown sugar
800 g fish fillets, halved
¼ cup fresh coriander leaves

Method:

Mix coconut milk, chilli sauce, lime rind, ginger, garam masala, fish sauce and brown sugar in a 2-litre dish. Cover and cook on High for 8 minutes, stir halfway through. Add fish, ensuring all surfaces are coated well. Cover and cook on Medium for 6 to 7 minutes, turning fish halfway through cooking. Allow standing for 5 minutes. Top with coriander leaves and serve with steamed rice.

OYSTERS KILPATRICK

Makes: 12

Ingredients:

2 rashers bacon finely chopped
1 tablespoon worcestershire sauce
2 teaspoons lemon juice
1 tablespoon barbecue sauce
12 oysters in shell

Method:

Spread bacon onto a dinner plate. Cover with paper towel and cook on High for 2 to 3 minutes. Mix together worcestershire sauce, lemon juice and barbecue sauce. Place oysters in shell evenly around dinner plate and sprinkle with bacon mixture. Pour some sauce mixture over each oyster. Cook on High for 1 to 1½ minutes.

SALMON MORNAY

Serves: 4

Ingredients:

40 g butter
1 onion, diced
¼ cup flour
1 tablespoon chopped fresh parsley
pepper
½ teaspoon prepared mustard
1½ cups milk
440 g can salmon and liquid
½ cup fresh bread crumbs
⅓ cup grated cheese

Method:

Place butter and onion in a 4-cup jug. Cook on High for 1 minute. Add flour and cook on High for 1 minute. Add parsley, pepper, mustard and gradually blend in milk. Cook on High for 2 to 3 minutes, stir halfway through cooking. Lightly mix through salmon and liquid into sauce. Pour into serving dish and top with bread crumbs and cheese. Cook for further 4 to 5 minutes on High power.

Cooking Whole Poultry by Micro power

Season as desired, but salt after cooking. Browning sauce mixed with equal parts of butter will enhance the appearance.

Poultry must be unstuffed. Tie legs together with cotton string. Place on a microwave rack set in a rectangular dish. Place poultry breast-side down: turn over halfway through cooking. Cover with wax paper to prevent splattering.

If the poultry is not cooked enough, return it to the oven and cook a few more minutes at the recommended power level.

DO NOT USE A CONVENTIONAL MEAT THERMOMETER IN THE MICROWAVE OVEN.

Let stand, covered with foil, 10 to 15 minutes after cooking. Standing time allows the temperature to equalize throughout the food and finishes the cooking process.

If a large amount of juice accumulates in the bottom of the baking dish, occasionally drain it. If desired, reserve juices for making gravy.

Less-tender birds should be cooked in liquid such as soup or broth. Use ¼ cup per 500g of poultry.

Use an oven cooking bag or a covered casserole. Select a covered casserole deep enough so that bird does not touch the lid.

If an oven cooking bag is used, prepare according to package directions. Do not use wire twist-ties to close bag. Use only nylon tie, a piece of cotton string, or a strip cut from the open end of the bag. Make six 2 cm slits on top of bag.

Multiply the weight of the poultry by the minimum recommended minutes per 500g. See chart below. Programme Micro Power and Time.

After cooking, check the internal temperature of the bird with a microwave or conventional meat thermometer inserted into the muscle. Check temperature in both muscles. The thermometer should not touch bone. If it does, the reading could be inaccurate. A thermometer cannot be accurately inserted into a small bird. To check desired cooking of a small bird, juices should be clear and the drumsticks should readily move up and down after standing time.

During cooking, it may be necessary to shield legs, wings and the breast bone with foil to prevent overcooking. Wooden toothpicks can be used to hold foil in place.



Cooking Poultry Pieces by Micro power

Cover with wax paper or paper towel. Use the chart below to determine recommended minimum cooking times.

Arrange pieces skin-side down and evenly spread in a shallow dish.

Turn or rearrange halfway through cooking. Shield wing tips, drumstick ends etc., if required.

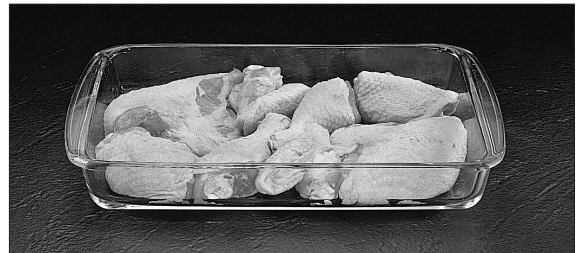

Cooking Poultry by Micro power

POULTRY	POWER	TEMPERATURE AFTER COOKING	APPROX. COOKING TIME (minutes per 500g)
Chickens (up to 2 kg)	Medium-High	87°C	10 to 15
Chicken (pieces)	Medium-High	87°C	8 to 10
Turkey (up to 2.5 kg)	Medium-High	87°C	12 to 17
Duck	Medium-High	87°C	10 to 15

Cooking Chicken Pieces by Auto Cook **A**

- **Minimum weight 400g / Maximum weight 1000 g**
- Suitable for cooking chicken pieces such as wings, drumsticks, thighs, half breasts etc.
- Chicken pieces should be thawed completely before cooking.
- Marinate chicken pieces prior to cooking, for added flavour and colour.
- Arrange chicken pieces on low Wire Rack, with the Glass Dish underneath to collect drips. At the half time of stage 2, the oven will 'beep' and prompt you to turn over and rearrange the chicken pieces.

To Operate for Auto Cook:

Auto Menu
(11-15)

Press 4 times to select Chicken Pieces, rotate the **Time/Weight** Dial to select desired weight, then press **Start**.

CHICKEN AND VEGETABLE KORMA

Serves: 4

Ingredients:

200 g	sweet potato
200 g	potato
1 tablespoon	oil
1	onion, diced
2	cloves garlic, crushed
1 teaspoon	ground coriander
1 teaspoon	ground cardamom
1 teaspoon	turmeric
1 teaspoon	ground cumin
1/2 teaspoon	ground cinnamon
1/4 cup	tomato paste
1 kg	chicken thigh fillets
1	small eggplant, diced
1/4 cup	natural yogurt

Fresh coriander, Mango chutney and Pappadums to serve

Method:

Peel potatoes and cut into 2 cm dice Place potatoes, oil, onion and garlic into a 3-litre microwave safe dish. Cover and cook on High for 3 minutes. Add spices to dish and cook on High for 1 minute. Stir in tomato paste and cook for a further 1-minute on High. Trim excess fat from chicken and cut fillets into thirds. Stir into vegetable mixture and cook covered on Medium-High for 10 minutes, stirring halfway through cooking. Add eggplant and cook for a further 5 minutes on High, stirring halfway through cooking. Stir through yogurt and serve with coriander, mango chutney and pappadums.

HONEY SESAME DRUMSTICKS **A**

Serves: 4

Ingredients:

1.0 kg	chicken drumsticks
1 teaspoon	chopped garlic
1 teaspoon	chopped ginger
1/4 cup	soy sauce
1/4 cup	honey
2 tablespoons	sesame seeds

Method:

Place all ingredients in a 2-litre bowl, stir until combined. Marinate for at least 2 hours or overnight. Remove chicken from marinade and place in shallow dish with the meatiest ends to the outside. Cook on Medium-High for 15 to 18 minutes, turning once during cooking.

CHICKEN BURRITOS

Serves: 4

Ingredients:

1	clove garlic, crushed
2	large onions, chopped
1 teaspoon	chilli powder (optional)
35 g	taco seasoning mix
500 g	chicken tenderloins, diced
425 g	can red kidney beans, drained
1/2 cup	tomato paste
1/2 cup	water
1 cup	grated cheese
12	tortillas

Method:

Place garlic, onion and chilli in a 3-litre casserole dish. Cook on High for 2 minutes. Stir in remaining all ingredients except cheese and tortillas. Cover and cook on Medium-High for 16 to 18 minutes, stirring twice during cooking. Serve in warmed tortillas topped with grated cheese.

Tip:

- * Many curry recipes use finely diced potato to break down during cooking and thicken the sauce. Potato doesn't break down when cooked in the microwave. Continued cooking will dehydrate the potato. If adapting your own recipe only use one quarter of the liquid.
- * Substitute 2 tablespoons of Korma curry paste for the spices and garlic in this recipe.
- * When using spices in cooking, toast in the microwave for 30 to 60 seconds to release their flavour and aroma before using in a recipe.

GREEN PEPPERCORN CHICKEN

Serves: 4

Ingredients:

500 g	sliced chicken breast fillets
2 tablespoons	green peppercorns
1 tablespoon	seeded mustard
1 teaspoon	chicken stock powder
2 tablespoons	lemon juice
½ cup	cream

Method:

Place chicken in a 3-litre casserole dish. Cook on Medium-High for 8 to 10 minutes stirring halfway through cooking. Mix together peppercorns, mustard, stock powder, lemon juice and cream. Pour over chicken, stir. Cook on High for 2 to 3 minutes.

THAI CHICKEN CURRY

Serves: 4

Ingredients:

1	onion, chopped
2 tablespoons	red curry paste
500 g	chicken fillets, sliced
1 tablespoon	fish sauce
1 tablespoon	brown sugar
2 cups	finely sliced vegetables
1 cup	coconut milk

Method:

Place onion and curry paste in a 3-litre casserole dish. Cook on High for 4 to 5 minutes. Add chicken and combine. Cook on Medium-High for 6 minutes, stirring once during cooking. Add fish sauce, brown sugar, vegetables and coconut milk. Stir well. Cover and cook on High for 4 to 6 minutes. Serve with Jasmine rice.

APRICOT NECTAR CHICKEN

Serves: 4

Ingredients:

400 ml	apricot nectar
40 g	French onion soup mix
1	onion, diced
1	clove garlic, crushed
½ cup	dried apricots
1 kg	chicken legs

Method:

Place all ingredients except chicken legs into a 3-litre dish. Mix well to combine. Add chicken legs and stir to coat with sauce. Cook on Medium-High for 20 to 25 minutes, stirring halfway through cooking.

CHICKEN CACCIATORE

Serves: 4

Ingredients:

400 g	can diced tomatoes
¼ cup	tomato paste
1 teaspoon	minced garlic
1	onion, diced
2 teaspoons	dried oregano
1 kg	chicken drumsticks
¼	red capsicum, sliced

Method:

Place all ingredients in a 2-litre casserole dish. Stir until combined. Cover and cook on Medium-High for 10 to 12 minutes. Turn chicken and stir. Cook on Medium-High for 10 to 12 minutes.

CHICKEN SAN CHOY BAU

Serves: 4

Ingredients:

10	dried shiitake mushrooms
2 teaspoons	sesame oil
1	clove garlic, chopped
500 g	minced chicken
10	water chestnuts, finely chopped
227 g	bamboo shoots, chopped
¼ cup	soy sauce
1 tablespoon	oyster sauce
2 tablespoons	sherry
1	small iceberg lettuce

Method:

Cover mushrooms with boiling water, stand for 30 minutes. Drain, remove stems and chop finely. Place oil and garlic in a 2-litre casserole dish, cook on High for 50-60 seconds. Add chicken and cook on Medium for 6 to 8 minutes. Add remaining ingredients except lettuce and cook on Medium for 6 to 8 minutes. Separate lettuce leaves, place tablespoons of mixture into each lettuce leaf. Serve immediately.

CHICKEN ROLLS WITH HONEY MUSTARD

Serves: 4 to 6

Ingredients:

8	chicken thigh fillets
16	prunes, pitted
8	green onions, sliced
2 tablespoon	flaked almonds
4 rashers	rindless bacon, halved lengthwise

Honey Mustard Glaze

1 tablespoon	brown sugar
1 tablespoon	French mustard
1 tablespoon	honey
10 g	butter, melted
	ground black pepper

Method:

Open out each thigh fillet and trim away fat. Place 2 prunes, some green onion and a few flaked almonds on each fillet. Roll fillets up and wrap a piece of bacon around each one. Secure with toothpicks. Blend all glaze ingredients together in a small bowl. Place chicken into a 3-litre dish in a single layer and brush with glaze mixture. Cook on Medium-High for 16 to 20 minutes, turning halfway through cooking.

LAYERED CHICKEN PUFF

Serves: 4 to 6

Dish: shallow dish and greased baking tray

Oven Accessory: Glass Dish then low wire rack

Ingredients:

600 g	boneless skinless chicken breasts
2 tablespoons	lemon juice
1 teaspoon	fresh thyme salt and pepper
200 g	jar of red peppers, drained
150 g	ripe brie
350 g	ready made puff pastry
1	egg, beaten to glaze
25 g	freshly grated parmesan

Method:

Slice the chicken breasts into strips and place between plastic film and flatten using a rolling pin. Put chicken into dish with lemon juice, thyme and seasoning. Allow to marinate for 2-3 hours in the fridge. Place chicken in dish and cover. Cook on **LOW MICROWAVE** for 15 mins or until cooked through. Remove chicken and allow to cool slightly. Roll out pastry to a 28 x 36cm (11" x 14") rectangle. Place ½ of the chicken on the centre third of the pastry. Cover with ½ of the peppers, then all of the brie then the rest of the peppers and finally the remaining chicken. Brush the edges of the pastry with beaten egg and draw up the two longer sides together over the filling and press the edges firmly together to seal. Flute the edges. Pre-heat the oven on **CONVECTION 200 °C**. Transfer the pastry onto the baking tray and brush with beaten egg. Sprinkle with parmesan cheese. Place on low wire rack and cook on **CONVECTION 200 °C** for 30-35 min turning tray around halfway. Until the pastry is crisp and golden.

Cooking Eggs by Micro Power

Boiled Eggs: Do not boil eggs in your microwave. Raw eggs boiled in their shells can explode and cause serious injury.

Poached Eggs: The membrane on egg yolks must be pierced before cooking, otherwise steam will build up and cause yolk to pop.

Scrambled Eggs: Slightly undercook scrambled eggs as they will finish cooking during standing.

BACON AND EGG IN A CUP

Serves: 1

Ingredients:

2 slices	bacon
1 x 60 g	egg
1 tablespoon	grated cheddar cheese

Method:

Place bacon on a dinner plate between 2 sheets of paper towel cook on High for 1 to 2 minutes. Wrap bacon around the inside of a 1-cup ramekin dish. Crack egg into centre of dish and pierce with tooth pick. Cover and cook on Medium for 50 to 70 seconds. Sprinkle with grated cheese.

POACHED EGGS

Serves: 2

Ingredients:

2 x 60 g	eggs
½ cup	hot water
	dash of vinegar
	pinch of salt

Method:

Place one quarter of cup of water, dash of vinegar and pinch of salt into 2 ramekin dishes or small glass bowls. Heat water on High for 30 to 60 seconds. Break egg into the water and with toothpick pierce the egg yolk twice and egg white several times. Cover dishes with plastic wrap and cook on Medium for 1 to 1½ minutes. Stand, covered, for 1 minute before serving.

Note: The size of the eggs will alter cooking time.

CRUSTLESS CHEESE AND SPINACH PIE

Serves: 4

Ingredients:

1	bunch spinach
6	green onions, thinly sliced
500 g	ricotta
2	eggs
1 tablespoon	plain flour
½ teaspoon	nutmeg
½ cup	grated cheddar
2	tomatoes, sliced (optional)

Method:

Wash and trim thick stalks from spinach. Chop leaves roughly. Pile onto a microwave safe dinner plate and cover with plastic wrap. Microwave on High for 2 minutes. Set aside to cool slightly. Place green onions into a small bowl cover and Microwave on High for 1 minute. Squeeze out excess moisture from cooked spinach. Place ricotta, eggs, spinach, green onions, flour and nutmeg in a large bowl, season to taste and fold with a spatula until well combined. Lightly grease a round (25 cm) microwave safe pie dish. Spread mixture evenly into prepared dish and sprinkle with grated cheddar. Microwave uncovered on Medium for 15 minutes or until centre is just slightly sunken.

Note: will even out on standing. Remove and stand for 2 minutes before cutting. Serve topped with sliced tomato.

SCRAMBLED EGGS

Serves: 2

Ingredients:

4 x 60 g	eggs
4 tablespoons	milk
	pinch of salt

Method:

In a 1-litre casserole dish, beat eggs lightly with whisk. Add milk and salt. Whisk until well combined. Cover dish with plastic wrap and cook on Medium for 2 to 2½ minutes. Stir eggs and cook for further 2½ to 3 minutes. Stand, covered, for 1 minute before serving.

YORKSHIRE PUDDINGS

Serves: 4 to 6

Dish: 12 section bun tin

Oven Accessory: low wire rack

Ingredients:

75 g	plain flour	pinch of salt
1	egg	
75 ml	milk	
75 ml	water	oil for tin

Method:

Place flour and salt in a mixing bowl. Make a well in the centre and break in egg. Beat egg into flour and gradually add milk and water, beating well until smooth. Stand until required. Place 5 ml (1tsp) oil in each section of Yorkshire Pudding bun tins. Place on low wire rack and preheat oven on **CONVECTION 220°C**. Pour batter into heated oil in tins. Place on low wire rack and cook on **CONVECTION 220°C** for 20-25 mins. or until well risen and brown.

Cooking Tender Cuts of Meat by Micro power

For best results, select roasts that are uniform in shape.

Place meat on a microwave rack in a suitable dish. Beef rib roast should be placed cut-side down. Other bone-in roasts should be placed fat-side down. Boneless roasts should be placed fat-side up. Halfway through cooking, turn roasts. Half hams should be shielded by wrapping an 8 cm wide strip of foil around the large end of the ham. Secure to the body of the ham with wooden toothpicks. Fold 3 cm over cut surface. For shank ham halves, shield shank bone by cupping it with foil. One third of the way through cooking, remove ham from oven and cut off skin. Turn fat side up and reshield edges. If desired, glaze last 10 to 20 minutes of cooking. Loosely cover baking dish with wax paper or paper towel to prevent splatter. If a large amount of juice accumulates in the bottom of the dish, drain occasionally. If desired, reserve for making gravy. Multiply the weight of the roast by the minimum recommended times per 500 g. Programme Micro Power and Time.

Meats can be shielded at the beginning of cooking or halfway through cooking. If you wish to shield at the

beginning of cooking, remove foil halfway through the cooking time. Beef and pork rib roasts should be shielded around the bones. Foil should extend about 5 cm down from bones. The shank and thin ends of boneless roasts should also be shielded. Make sure foil does not touch the sides of the oven, as arcing may occur. Canned hams should be shielded on the top cut-edge with a 3 cm strip of foil. Wrap strip of foil around ham and secure to body of ham with wooden toothpicks. Fold 2 cm over cut surface. After heating, check temperature using a meat thermometer. The thermometer should not touch bone or fat. If it does, the reading could be inaccurate. Lower temperatures are found in the centre of the roast and in the muscle close to a large bone, such as a pork loin centre rib roast. If the temperatures are low, return meat to the oven and cook a few more minutes at the recommended power level. **DO NOT USE A CONVENTIONAL MEAT THERMOMETER IN THE MICROWAVE OVEN.** Let stand, covered with foil, 10 to 15 minutes. During standing time the internal temperature equalises and the temperature rises 5°C to 10°C.

Cooking Less-Tender Cuts of Meat by Micro power

Less-tender cuts of meat such as pot roasts should be cooked in liquid. Use ½ to 2 cups of soup, broth, etc. per 500 g of meat. Use an oven cooking bag or covered casserole when cooking less-tender cuts of meat. Select a covered casserole deep enough so that the meat does not touch the lid. If an oven cooking bag is used, prepare the bag according to package directions. Do not use wire or metal

twist-ties. Use the nylon tie provided, otherwise, use a piece of cotton string or a strip cut from the open end of the bag. Make six 2 cm slits in top of bag to allow steam to escape. Multiply the weight of the roast by the minimum recommended minutes per 500 g as suggested in the chart below. Programme Power and Time. Turn meat over halfway through cooking. Meat should be tender when cooked.

Cooking Meat by Micro power

MEAT	POWER	APPROX. COOKING TIME (minutes per 500 g)
Beef		
Roasts		
Rare	Medium	8 to 10
Medium	Medium	10 to 12
Well	Medium	12 to 14
Pot Roast	Medium-Low	25 to 30
Pork		
Leg of Pork	Medium-High	11 to 13
Loin of Pork	Medium-High	12 to 14
Ham Canned (fully cooked)	Medium-High	5 to 6
Lamb		
Medium	Medium	9 to 11
Well	Medium	12 to 14

ITALIAN BEEF CASSEROLE WITH POLENTA**DUMPLINGS**

Serves 4 to 6

Ingredients:

2/3 cup	polenta
300 ml	boiling water
1/4 cup	grated Parmesan cheese
1	onion, sliced
2	cloves garlic, crushed
1 kg	diced beef
1 tablespoon	flour
1 cup	beef stock
1	red capsicum, de-seeded, roasted, peeled and sliced
800 g	can crushed tomatoes
1 tablespoon	fresh oregano, chopped
2 tablespoons	pre-prepared pesto

Method:

Pour polenta into boiling water and stir until well combined. Cook on High for 2 minutes or until mixture leaves the sides of the dish. Stir in Parmesan cheese and allow to cool.

Place remaining ingredients, except pesto, into a 3-litre casserole dish. Stir well and cook on high for 10 minutes. Stir and continue cooking on Medium for 35 to 40 minutes, stir several times during cooking. Shape polenta into 12 balls and place them on top of the casserole. Cook on medium for 10 minutes. Serve casserole topped with pesto.

THAI BEEF CURRY

Serves: 4 to 6

Ingredients:

1	onion, thinly sliced
2 tablespoons	Thai green curry paste
500 g	thinly sliced lean beef
1/2	red capsicum, thinly sliced
1	carrot, thinly sliced
1	zucchini, sliced
200 g	broccoli, broken into flowerets
1 cup	coconut milk
1 tablespoon	soy sauce
1 tablespoon	lemon juice
2 tablespoons	shredded fresh basil
1/2 cup	roasted unsalted peanuts

Method:

Place the onion and curry paste into a 4-litre dish. Cook on High for 2 to 3 minutes. Add the beef and cook on High for 4 to 6 minutes, stirring halfway through cooking. Add the vegetables and coconut milk and cook on High for 6 to 8 minutes. Mix in the soy sauce, lemon juice and basil and serve sprinkled with peanuts.

LAMB KORMA

Serves: 4

Ingredients:

1	onion, diced
500 g	lamb, cubed
1/3 cup	korma curry paste
2 large	carrots sliced
250 ml	tomato puree
250 ml	beef stock
2 tablespoons	natural yoghurt

Method:

Place onion, lamb, curry paste and carrot in a 3-litre casserole dish. Cook on High for 6 minutes. Add tomato puree and beef stock, stir, cook on Medium for 40 minutes, stirring once during cooking. Stir in yoghurt and serve with basmati rice.

MUSSAMAN BEEF CURRY

Serves: 4

Ingredients:

500 g	round steak diced
1/3 cup	mussaman curry paste
400 g	potato diced
250 ml	coconut milk
250 ml	beef stock
1 tablespoon	brown sugar

Method:

Place steak, curry paste and potato in a 3-litre casserole dish cook on High for 6 minutes. Add coconut milk, beef stock and brown sugar, stir, cook on Medium for 40 minutes. Stir once during cooking serve with jasmine rice.

TOAD IN THE HOLE

Serves: 4

Dish: 27 x 22 cm (10 1/2 " x 8 1/2 ") oblong tin
Oven Accessory: Oven Tray in lower position

Ingredients:

150 g	plain flour
1/2 teaspoon	salt
2	eggs
150 ml	milk
150 ml	water
1-2 tablespoons	oil
450 g	sausages

Method:

Preheat oven on **CONVECTION 220 °C**. Sift flour and salt in a bowl. Add eggs and half the liquid. Beat until smooth and gradually stir in remaining liquid. Put oil and sausages in tin and place on Oven Tray. Cook on **CONVECTION 220 °C** for 15 mins. Pour in the batter and cook on **CONVECTION 220 °C** for a further 30-35 mins. or until the batter is well risen and golden brown.

HINT:

It is better to cook meat for a lesser time in a recipe and add extra time if needed. This will prevent over cooking.

SPAGHETTI MEAT SAUCE

Serves: 4 to 6

Ingredients:

500 g	minced beef
1	onion, chopped
1 teaspoon	minced garlic
425 g	can tomatoes
1 cup	tomato puree
¼ cup	red wine
1 teaspoon	dried mixed herbs
	pepper

Method:

Place beef, onion and garlic in a 3-litre casserole dish. Cook on High for 5 to 6 minutes. Add remaining ingredients. Stir. Cook on Medium-High for 16 to 18 minutes. Stir halfway through cooking. Serve with spaghetti.

BEEF STROGANOFF

Serves: 4

Ingredients:

1	onion, sliced
1 teaspoon	minced garlic
1 teaspoon	paprika
750 g	rump steak sliced thinly
2 tablespoons	tomato sauce
2 tablespoons	worcestershire sauce
1	beef stock cube
200 g	sliced mushrooms
⅓ cup	sour cream

Method:

Place all ingredients (except sour cream and mushrooms) in a 3-litre casserole dish. Stir until combined. Cover. Cook on Medium-High for 7 to 9 minutes, stirring once during cooking. Add mushrooms. Stir and cook on Medium-High for 3 to 4 minutes. Stir through sour cream.

CHINESE BEEF AND VEGETABLES

Serves: 4 to 6

Ingredients:

500 g	rump steak sliced
1 teaspoon	chopped fresh ginger
1 clove	garlic, chopped
1 tablespoon	soy sauce
¼ cup	Hoisin sauce
¼ cup	sweet chilli sauce
3 cups	sliced vegetables

Method:

Place steak, ginger and garlic in a 3-litre casserole dish. Cook on High for 1 minute. In a 1-cup jug, combine soy sauce, Hoisin sauce and sweet chilli. Add to meat mixture. Cook on High for 3 to 4 minutes. Add the vegetables, cover and cook on High for 3 to 5 minutes, stirring halfway through cooking. Let stand for 5 minutes before serving.

FRENCH ONION BEEF CASSEROLE

Serves: 4

Ingredients:

1	onion, chopped
1 teaspoon	minced garlic
200 g	diced potatoes
600 g	beef, diced
2	carrots, diced
⅓ cup	tomato paste
1½ cups	beef stock
100 g	whole button mushrooms
¼ cup	frozen peas

Method:

Place onion and garlic in a 3-litre casserole dish. Cook on High for 1 to 2 minutes. Add remaining ingredients, except mushrooms and peas. Stir until combined. Cover and cook on High for 8 minutes. Stir and cook on Medium for 28 to 30 minutes. Add mushrooms and frozen peas. Stir cook on Medium for 14 to 15 minutes.

SEASONED ROAST LAMB

Serves: 4 to 6

Ingredients:

1.4 kg	leg of lamb
1 tablespoon	seeded mustard
1 tablespoon	rosemary

Method:

Place lamb fat side down on rack set in a 3-litre dish. Brush with mustard and rosemary. Cook on Medium for 30 to 35 minutes, turn halfway through cooking. Stand, covered, for 15 minutes before slicing.

CHILLI BEEF

Serves: 4

Ingredients:

500 g	topside beef mince
1 teaspoon	minced garlic
35 g	chilli seasoning mix
400 g	tomato purée
400 g	kidney beans, drained

Method:

Place all ingredients in a 3-litre dish. Mix well. Cook on Medium-High for 15 to 17 minutes. Stir halfway through cooking. Serve in taco shells with chopped tomatoes and shredded lettuce or with a salad and crusty bread.

LASAGNE

Serves: 4 to 6

Ingredients:**Meat Sauce:**

500 g	minced beef
2	small onions, chopped
1	clove garlic, chopped
425 g	tomato purée
1 cup	beef stock
¼ cup	chopped basil
1 tablespoon	cracked black pepper

Cheese Sauce:

80 g	butter
¼ cup	flour
500 ml	milk
1 cup	grated cheese
½ cup	Parmesan cheese
12	lasagne sheets, cooked
½ cup	extra grated cheese

Method:**Meat Sauce:**

Place beef, onion and garlic in a 3-litre casserole dish. Cook on High for 5 to 6 minutes. Add remaining sauce ingredients. Cook on Medium-High for 15 to 20 minutes, stirring several times during cooking. Set aside.

Cheese Sauce:

Melt butter in a 2-litre jug on High for 30 to 40 seconds. Add flour and mix well. Gradually stir in milk. Cook on High for 3 to 4 minutes. Stirring halfway through cooking. Add grated cheese and Parmesan cheese. Cook on High for 50 to 60 seconds. Spoon quarter of the meat sauce into the base of 25 x 25 cm deep casserole dish. Top with three lasagne sheets. Spoon another quarter of meat sauce over the lasagne sheets and spread with cheese sauce. Continue with remaining ingredients. Top with meat and cheese sauce. Sprinkle with extra cheese and cook on Medium-High for 20 to 25 minutes.

GOULASH

Serves: 4

Ingredients:

1	onion, chopped
1	clove garlic, crushed
1 tablespoon	butter
2 tablespoons	tomato paste
½ teaspoon	paprika
500 g	lamb, diced
1	small capsicum, diced
1 cup	beef stock
2 tablespoons	flour
2 tablespoons	water
2 tablespoons	sour cream

Method:

Place onion, garlic and butter in a 3-litre casserole dish. Cook on High for 1 to 2 minutes. Add tomato paste and paprika. Cook on High for a further 2 minutes. Add lamb, capsicum and stock. Cover and cook on Medium for 25 to 30 minutes, stirring halfway through cooking. Mix flour with 2 tablespoons of water and stir into goulash mixture. Cook on High for 1 to 2 minutes. Stir in sour cream and serve with pasta and rice.

CORNER BEEF

Serves: 4

Ingredients:

1.5	corned silverside
1 tablespoon	brown sugar
1 tablespoon	white vinegar
1	onion, cut in half
4	cloves
6	peppercorns
1	bay leaf
5 cups	water

Method:

Rinse corned silverside under cold running water to remove excess salt. Place corned silverside in a 4-litre casserole dish. Add remaining ingredients. Cover and cook on High for 10 minutes. Turn meat, cover and cook on Medium-Low for 1¼ to 1½ hours. Stand corned silverside in cooking liquid for 10 minutes before carving.

Note: Depending on the size and shape of the silverside, it may require a further 10 to 15 minutes on Medium-Low.

LAMB PILAU

Serves: 4

Ingredients:

1	large onion, sliced
1 tablespoon	oil
600 g	lean diced lamb
400 g	can tomato pieces
2 tablespoons	garam masala
1 teaspoon	dried thyme
1 cup	long grain rice
600 ml	hot chicken stock
150 g	natural yoghurt
	freshly ground black pepper

Method:

Place the onion and oil in a 3 litre dish. Cover and cook on High for 2 to 3 minutes. Add lamb, tomato pieces, garam masala, and thyme. Cover and cook on Medium-High for 10 minutes. Stir. Cook on Medium-High for a further 10 minutes. Add the rice and chicken stock and cook covered on Medium for a further 30 minutes or until the rice is tender. Stir in yoghurt, season with pepper and serve.

GINGERED PORK STIR FRY

Serves: 4

Ingredients:

500 g	sliced lean pork
¼ cup	teriyaki sauce
1 tablespoon	honey
2 teaspoons	minced ginger
2 teaspoons	cornflour
1	onion, sliced
300 g	sugar snap peas, trimmed
1	zucchini, sliced
½	red capsicum, sliced
2	green onions, sliced
½ cup	bean sprouts
1 tablespoon	toasted sesame seeds

Method:

Place pork, teriyaki sauce, honey, ginger and cornflour in a 2-litre dish. Cover and marinate in the refrigerator for 2 hours. Place onion in a 3 litre dish. Cook on High for 1 to 2 minutes. Add marinated pork and sauces and cook on Medium-High for 3 to 4 minutes. Add peas, zucchini, capsicum, green onions and bean sprouts. Cook on High for 3 to 4 minutes. Sprinkle with sesame seeds and serve with noodles.

Cooking Fresh Vegetables by Micro power

Place vegetables in a casserole dish. Add 2 to 3 tablespoons of water per 500g of vegetables. Add salt to water or add after cooking. Do not place salt directly on vegetables. Cover dish with glass lid or plastic wrap.

Cook on HIGH according to time recommended in the chart.

Vegetables that are to be cooked whole and unpeeled, need to be pierced to allow steam to escape. Place vegetables on a paper towel lined dinner plate. Allow to stand, covered, according to the time indicated in the charts.

Cooking Fresh Vegetables by Micro power

Vegetables should be covered and cooked on High power for best results. Weights given are trimmed weights.

VEGETABLE	QUANTITY	COOKING PROCEDURE	APPROX. COOKING TIME (in minutes) on High
Asparagus	250 g	Covered dish with ¼ cup water.	1 to 3
Beans (finely sliced)	250 g	Covered dish with ¼ cup water.	3 to 5
Beetroot	4 whole (1 kg)	Covered with 1 cup water in 4-litre dish. Stand after cooking - 5 mins.	14 to 18
Broccoli	250 g	Covered dish with ¼ cup water.	4 to 6
Brussels Sprouts	500 g	Covered dish with ¼ cup water.	5 to 7
Cabbage	500 g	Shredded, with ¼ cup water in covered dish.	5 to 7
Carrots	4 (sliced finely) 250 g	With ¼ cup water in covered dish.	3 to 4
Cauliflower	500 g	With ¼ cup water in covered dish.	6 to 8
Celery	6 stalks (400 g) cut in 1 cm pieces	With ¼ cup water in covered dish.	4 to 6
Corn	2 cobs (500 g) 4 cobs (1 kg)	Brush with melted butter and cook in covered dish.	4 to 6 10 to 12
Eggplant	1 (500 g)	Dice with ¼ cup water in covered dish.	4 to 6
Mushrooms	250 g (sliced)	Cook with 2 tablespoons butter in covered dish.	2 to 4
Onions	3 (200 g)	Cut in quarters with ¼ cup water in covered dish.	5 to 7
Peas	250 g	Shell peas and place with ¼ cup water in covered dish.	3 to 5
Potatoes-Mashed -Jacket	500 g 3 Medium	Peeled and quartered with ¼ cup water. Covered. Cook uncovered on paper towel lined plate.	10 to 12 7 to 9
Pumpkin	500 g	Peeled and cut into uniform pieces with ¼ cup water in covered dish.	6 to 8
Spinach / Silver Beet	250 g	Remove stem, cut leaves into small pieces. Cook with ¼ cup water in covered dish.	4 to 6
Sweet Potato	500 g	In serving size pieces with 2 tablespoons water in covered dish.	6 to 8
Turnips	500 g	Peeled and sliced finely with ¼ cup water in covered dish.	6 to 8
Tomatoes	2 (300 g)	Sliced and cooked covered.	2 to 4
Zucchini	500 g	Cut in 2 cm pieces in covered dish.	5 to 7

COOKING FROZEN VEGETABLES BY MICRO POWER

Remove vegetables from package and place in an appropriate sized container. Vegetables frozen in a pouch should be placed on a dish and the top pierced. Cook on High according to directions given in chart. Vegetables should be cooked covered with a lid or plastic wrap.

Stir after cooking. Allow to stand for 2 to 3 minutes before serving.

Cooking Frozen Vegetables by Micro power

VEGETABLE	QUANTITY	COOKING PROCEDURE	APPROX. COOKING TIME (in minutes) on High
Beans	250 g	Cook in covered 2-litre dish.	4 to 6
Broad Beans	250 g	Cook in covered 2-litre dish.	5 to 7
Broccoli (spears)	350 g	Cook in covered 2-litre dish.	5 to 7
Brussels Sprouts	250 g	Cook in covered 2-litre dish.	5 to 7
Carrots (baby)	250 g	Cook in covered 2-litre dish.	6 to 8
Cauliflower	500 g	Cook in covered 2-litre dish.	5 to 7
Corn (½ cob)	125 g	Cook in covered 2-litre dish.	3 to 4
Corn (cobs)	250 g	Cook in covered 2-litre dish.	5 to 7
Mixed Vegetables	250 g	Cook in covered 2-litre dish.	5 to 7
Peas	250 g	Cook in covered 2-litre dish.	4 to 6
Spinach	250 g	Cook in covered 2-litre dish.	4 to 6

COOKING DRIED BEANS AND PEAS BY MICRO POWER

Place hot tap water in 4-litre dish. Bring hot water to the boil on High for 10 to 12 minutes. Add beans and 2 tablespoons oil to water. Cook according to directions in chart. Stir. Allow to stand, covered, for 15 to 20 minutes.

Note: Beans such as red kidney beans and lima beans should be soaked overnight before cooking. 250 g of dried beans equals about 3 cups cooked beans. Use in place of canned beans.

Cooking Dried Beans and Peas by Micro Power

ITEM	CONTAINER	TO COOK BEANS on Medium (in minutes) COVERED
Lentils (250 g)	4-litre dish	15 to 20
Soup Mix (250 g)	4-litre dish	20 to 25
Split Peas or Lentils (250 g)	4-litre dish	25 to 30
Beans (250 g) Soaked overnight	4-litre dish	25 to 30

FROZEN VEGETABLES BY AUTO COOK [A]

- **Minimum weight 200 g / Maximum weight 500 g**
- Suitable for heating varieties of frozen vegetables, including peas, beans, corn kernels, broccoli, cauliflower etc.
- Place larger pieces or quantities in a single layer for best results.
- Add 1 tablespoon to ¼ cup water, if you prefer a softer cooked texture.
- Very icy vegetables that have frozen in a solid mass may require slightly longer cooking times.
- Place vegetables in an appropriate size dish. Use the following as a guide:

Weight	Dish Size
200 g	500 ml
300 g	750 ml
400 g	1 litre
500 g	1 litre

- Cover with plastic wrap or a well fitting lid.
- If desired, butter, herbs etc. may be added, but do not add salt until serving. (Salt dehydrates vegetables during cooking.)
- At the end of the cooking time, stir vegetables and let stand, covered, for 2 to 3 minutes.

To operate by Auto Cook:

Auto Menu
(1-5)

Press twice to select Frozen Vegetables, rotate the **Time/Weight** Dial to select the desired weight, then press **Start**.

COOKING ROOT VEGETABLES BY AUTO

Cook **A**

Root Vegetables

- **Minimum weight 250 g / Maximum weight 900 g**
- Suitable for cooking root vegetables such as potatoes, sweet potatoes, pumpkin, onions, swede, carrots, turnip and beetroot.
- All vegetables should be trimmed or prepared and cut into even sized pieces.
- Add 1 tablespoon to ¼ cup of water to vegetables if dehydrated or a softer cooked texture is desired.
- Place into an appropriate size dish and cover securely with plastic wrap or a fitted lid.
- If desired, butter, herbs etc. may be added but do not add salt until after cooking.
- Halfway through the cooking time, the oven will 'beep' and prompt you to rearrange the vegetables.
- At the completion of cooking, stir larger quantities of vegetables. Let stand, covered, for 2 to 3 minutes.

RED COCONUT DHAL

Serves: 4 to 6

Ingredients:

1 cup	red lentils
1 teaspoon	turmeric
400 ml	coconut milk
250 ml	water
1 teaspoon	crushed red chilli
1 teaspoon	crushed garlic
lemon juice to taste	

Method:

Place all ingredients in a 2 litre casserole dish. Stir and cook on Medium for 18 to 20 minutes, stirring twice during cooking.

HUMMUS

Ingredients:

1 cup	chick peas, water for soaking
3 cups	boiling water
2 tablespoons	lemon juice
2 teaspoon	turmeric
¼ cup	tahini (sesame paste)
4 cloves	garlic, minced
2 tablespoons	olive oil

Method:

Place chickpeas and water into a 4-litre casserole dish and soak overnight. Drain.
Place chickpeas and boiling water into a 3-litre casserole dish and cook on Medium for 25 to 30 minutes. Drain, process with remaining ingredients.

CHICKPEA SALAD WITH CORIANDER DRESSING

Serves: 4 to 6

Ingredients:

1 cup	dried chickpeas, water for soaking
3 cups	boiling water
1	red capsicum, diced
1	lebanese cucumber, diced
250 g	cherry tomatoes, quartered
1	Spanish onion, diced

Coriander Dressing:

½ cup	lemon juice
2 teaspoons	sugar
½ cup	chopped fresh coriander
1 teaspoon	chopped red chilli

Method:

Cover chickpeas with water and soak overnight. Drain. Place chickpeas and boiling water into a 3-litre dish and cook on Medium-High for 25 to 30 minutes. Drain and allow to cool.
Combine remaining salad ingredients in a large bowl and mix well.

Dressing:

Combine all ingredients in a screw top jar, shake well. Pour over salad and toss well.

GOATS CHEESE & ONION TART

Serves: 4

Dish: large bowl, 23 cm (9") flan tin/dish, Oven Tray greased
Oven Accessory: low wire rack

Ingredients:

375 g	ready rolled puff pastry
2 tablespoons	olive oil
1 kg	red onions, peeled & thinly sliced
1 tablespoon	fresh thyme
6 tablespoons	balsamic vinegar
2 teaspoons	muscovado sugar salt and freshly ground black pepper balsamic glaze for decoration
200 g (7 oz)	soft goat's cheese, cut into slices

Method:

Pre-heat oven on **CONVECTION 200 °C**.
Line the flan dish with the pastry, prick the base with a fork and chill for 15 mins. in the fridge. Place flan on low wire rack and bake blind on **CONVECTION 210°C** for 15 mins. with baking beans. Remove baking beans and lining after 10 mins. Place the oil, onions and thyme into a large bowl. Place on base and cook on **HIGH MICROWAVE** for 5 mins. Add balsamic, stir and cook on **HIGH MICROWAVE** for 10 mins. Stir halfway and season. Pre-heat oven on **CONVECTION 200 °C**. Place the onions on the pastry. Decorate with cheese and cook on **CONVECTION 200°C** for 10-12 mins.

VEGETABLE FRITTATA

Serves: 4 to 6

Ingredients:

400 g	potatoes, thinly sliced
1/2	red capsicum, sliced into strips
1/2	green capsicum, sliced into strips
1	tomato, diced
2 tablespoons	fresh basil, chopped
4	eggs
1/3 cup	sour cream
1/2 teaspoon	cracked black pepper
1/2 cup	grated tasty cheese

Method:

Place potatoes in a 2-litre shallow dish. Cook on High for 5 to 7 minutes. Arrange capsicum in a circular pattern on top of potato sprinkle with tomato and basil. Beat together eggs and sour cream in a jug. Pour over vegetables. Cook on Medium for 3 to 5 minutes. Sprinkle with pepper and cheese and cook on Medium for 7 to 9 minutes.

HONEY GLAZED CARROTS AND SUGAR SNAP PEAS

Serves: 4 to 6

Ingredients:

350 g	carrots
150 g	sugar snap peas, trimmed
2 tablespoons	brown sugar
2 teaspoons	butter
2 tablespoons	honey
1 tablespoon	toasted sesame seeds

Method:

Peel and thinly slice carrots. Combine all ingredients in a 2-litre casserole dish. Cover and cook on High for 6 to 8 minutes, stirring halfway through cooking. Serve.

CREAMED SPINACH A

Serves: 4

Ingredients:

1	bunch spinach, roughly chopped
4	green onions, finely chopped
1	clove garlic, crushed
2 tablespoons	sour cream
	salt and pepper

Method:

Cook washed spinach leaves, green onions and garlic in a covered 3-litre casserole dish on High for 4 to 6 minutes.

Drain well by squeezing between two dinner plates. Stir through sour cream. Season to taste. Cook on High for 1 to 2 minutes. Serve.

ROASTED VEGETABLES

Serves: 4

Dish: bowl

Oven Accessory: no accessory then Oven Tray on lower level

Ingredients:

2 parsnips	(peeled and cut into chunky pieces)
2 peppers	(deseeded and cut into bite-sized chunks)
100 g	mushrooms (washed and chopped in half)
1	leek cut into chunks
1-2 tbsps	olive oil
2	garlic cloves crushed

Method:

Place the vegetables into a bowl, add 6tbsp water and cover, cook on **HIGH MICROWAVE** for 5-7 mins. Drain and cool slightly. Preheat oven empty on **CONVECTION 220 °C**. Put the olive oil and the vegetables onto the Oven Tray. Place the Oven Tray into the oven and cook on **CONVECTION 220 °C** for 25-30 mins, shaking occasionally for until golden brown and soft. Stir the honey, pepper and a sprinkling of salt into the vegetables, then return to the oven for 5mins to warm honey through. Toss vegetables half way through.

ARDENNIS STYLE POTATOES A

Serves: 4

Ingredients:

4	medium sized potatoes
100 g	ham, finely diced
3 tablespoons	snipped chives
50 g	butter
1/2 cup	grated Cheddar cheese
	ground black pepper

Method:

Scrub potatoes, wash and pat dry with paper towel. Prick skins and place in a 2-litre casserole dish. Cook on High for 6 to 8 minutes.

To cook by Auto Cook:

Prepare as above. Cover with plastic wrap.

Auto Menu
(1-5)

Press 3 times to select Root Vegetables, rotate the **Time/Weight** Dial to select 900 g, then press **Start**.

Allow to cool slightly. Cut tops off potatoes and scoop out pulp from centre, leaving 1 to 2 cm in shell. Mash pulp and combine with remaining ingredients. Spoon filling back into potato shells. Place potatoes in a 2-litre casserole dish. Cook on High for 2 to 3 minutes.

CAULIFLOWER AU GRATIN

Serves: 4

Ingredients:

500 g	cauliflower, trimmed and cut into pieces
2 tablespoons	water
2 tablespoons	butter
2 tablespoons	flour
1 cup	milk
1/4 cup	grated tasty cheese

Method:

Place cauliflower and water in a shallow casserole dish. Cover and cook on High for 6 to 8 minutes. Stand, covered, while making sauce. Place butter in a 4-cup glass jug. Cook on High for 1 minute. Stir in flour and cook on High for 1 minute. Add milk gradually. Stir well. Cook on High for 2 to 3 minutes, stirring halfway through cooking. Drain cauliflower and pour over sauce. Sprinkle with cheese. Cook on Medium-High for 1 to 2 minutes.

Note: Depending on size and arrangement of cauliflower pieces, timing will vary.

HINT:

TO SKIN TOMATOES: Cut a cross into the tomato skin. Place 1 cup of hot tap water in a 2 cup jug or bowl and heat on High for 1 1/2 minutes or until boiling. Add 1 tomato and heat for a further 20 to 30 seconds. Remove and repeat procedure with remaining tomatoes. The skin will loosen and can be easily removed.

THAI VEGETABLE CURRY

Serves: 4

Ingredients:

1	onion, sliced
2 tablespoons	green curry paste
3 cups	sliced vegetables
440 g	can chick peas, drained
1 cup	coconut milk
1 tablespoon	lemon juice
1 tablespoon	soy sauce
1/2 cup	chopped nuts

Method:

Place onion and curry paste in a 3-litre casserole dish. Cook on High for 2 minutes. Add vegetables, chick peas, coconut milk, lemon juice and soy sauce. Cook on High for 6 to 8 minutes. Sprinkle with chopped nuts. Serve with jasmine rice.

HERBED VEGETABLES

Serves: 4 to 6

Ingredients:

200 g	sliced snow peas
200 g	sliced carrots
200 g	sliced zucchini
2 tablespoons	chopped fresh parsley

Method:

Place snow peas, carrots and zucchini in a 2-litre casserole dish. Cover. Cook on High for 6 to 7 minutes, stirring once during cooking. Sprinkle with parsley. Serve.

TOMATO VEGETABLE CASSEROLE

Serves: 4 to 6

Ingredients:

200 g	mushrooms, sliced
1	eggplant, chopped
200 g	zucchini, sliced
1	capsicum, sliced
1	onion, sliced
400 g	can tomatoes
1/2 cup	tomato paste
1 tablespoon	chopped basil
1 teaspoon	minced garlic

Method:

Place mushrooms, eggplant, zucchini, capsicum and onion in a 3-litre casserole dish. Cover. Cook on Medium-High for 10 minutes. Add tomatoes, tomato purée, herbs and garlic. Re-cover and cook on High for 8 to 10 minutes.

POTATO BAKE

Serves: 4 to 6

Ingredients:

750 g	peeled and sliced potatoes
300 ml	cream
1/4 cup	milk
3	green onions, sliced
2	bacon rashers, chopped
1/2 cup	grated cheese

Method:

Combine potatoes, cream and milk in a 2-litre casserole dish. Cook on High for 15 to 18 minutes. Top with green onions, bacon and cheese. Cook on High for 5 minutes.

SAVOURY BRUSSELS SPROUTS A

Serves: 4

Ingredients:

250 g	brussels sprouts
2 tablespoons	butter
150 g	bacon, finely chopped
1	onion, finely chopped
1 teaspoon	dill or basil
1 teaspoon	sugar

Method:

Wash and drain brussels sprouts. Cook in a covered 2-litre casserole dish on High for 4 to 5 minutes. Drain and set aside. Place remaining ingredients in separate 2-litre casserole dish. Cook on High for 3 to 5 minutes. Add brussels sprouts and cook on High for 1 to 2 minutes. Serve.

CHEESY MASHED POTATOES

Serves: 4

Ingredients:

500 g	potatoes, peeled and diced
1/4 cup	water
1/3 cup	milk
1/4 cup	grated cheese

Method:

Place potatoes and water in a 2-litre casserole dish. Cover and cook on High for 10 minutes. Drain. Mash potatoes with milk and grated cheese. Mix well. Cook on High for 1 minute. Stir well before serving.

PARMESAN ASPARAGUS

Serves: 2 to 4

Ingredients:

1	bunch of asparagus spears
2 tablespoons	water
1 tablespoon	butter
1	clove garlic, crushed
1 tablespoon	grated Parmesan cheese

Method:

Place asparagus and water in a 2-litre casserole dish. Cover and cook on High for 1 to 2 minutes. Drain. Place butter and garlic in small dish and cook on High for 1 minute. Add drained asparagus and mix lightly. Cook on High for a further 1 minute. Sprinkle Parmesan cheese over asparagus. Serve.

HINT:

It is better to slightly undercook vegetables as they will soften on standing. Allow to stand, covered, with plastic wrap or a lid.

HINT:

Wrap jacket potatoes in foil after cooking. They will retain their heat for about 15 to 20 minutes.

Cooking Rice by Micro power

Follow directions in chart for recommended dish size, amounts of water and cooking time. Add rice to water. Add salt and butter according to package directions. Cook on High for time recommended in

chart. Allow to stand, covered, before serving. For special rice, substitute beef or chicken stock for water. Add cooked onion, mushrooms or crumbled bacon before serving.

ITEM	CONTAINER	AMOUNT OF WATER	APPROX. TIME TO COOK RICE on High UNCOVERED (in minutes)	STANDING TIME (in minutes)
RICE				
Quick Cook Brown (1 cup)	2-litre dish	1 $\frac{1}{3}$ cups	10 to 12	5
Brown (1 cup)	4-litre dish	3 cups	25 to 30	10
Long Grain (1 cup)	3-litre dish	2 cups	12 to 14	5
Short Grain (1 cup)	3-litre dish	2 cups	12 to 14	5

Cooking Rice by Auto Cook

- **Minimum weight 100 g / Maximum weight 400 g**
- Suitable for cooking white rice including short, long grain and specialty rices.
- Place rice with water at room temperature in a suitable sized dish.
Use the following as a guide:

Rice	* Water	Dish Size
100 g	200 ml	3 litre
200 g	300 ml	3 litre
300 g	350 ml	4.5 litre
400 g	450 ml	4.5 litre

*(It may be necessary to adjust the amount of water to your personal preference.)

- Rice will boil over if the dish used is too small.
- Cook rice uncovered.
- Do not cook in plastic containers unless suitable for high temperature cooking.
- Stand rice for 5 to 10 minutes after cooking, if necessary.
- This setting is not suitable for cooking brown rice.

To operate:

Auto Menu
(1-5)

Press  4 times to select Rice, rotate the **Time/Weight** Dial to select the desired weight, then press **Start**.

FRAGRANT COCONUT RICE

Serves: 4 to 6

Ingredients:

1	onion, chopped
2 cups	long grain rice
500 ml	chicken stock
400 ml	coconut milk
1 teaspoon	turmeric

Method:

Place all ingredients in a 3-litre casserole dish. Stir. Cook on High for 15 to 18 minutes. Cover and let stand 10 minutes before serving.

SEASONED RICE

Serves: 4 to 6

Ingredients:

1	onion, chopped
1 cup	long grain rice
1 teaspoon	thyme
1 $\frac{1}{2}$ cups	chicken stock
$\frac{1}{4}$ cup	toasted slivered almonds

Method:

Place onion, rice, thyme and chicken stock in a 3-litre casserole dish. Cook on High for 14 to 16 minutes. Stir, cover, and let stand for 10 minutes. Stir through slivered almonds and serve hot.

CHICKEN AND ASPARAGUS RISOTTO

Serves: 4

Ingredients:

300 g	fresh asparagus, chopped
2 tablespoon	olive oil
1½ cups	arborio rice
1	clove garlic, crushed
4 cups	boiling chicken stock
2 cups	coarsely chopped cooked chicken
¼ cup	grated fresh parmesan cheese
¼ cup	cream
	ground black pepper
extra	coarsely grated parmesan cheese

Method:

Place asparagus into a 2-litre dish and cook on High for 1 minute. Set aside. Place oil, rice and garlic in a large microwave safe bowl. Cook covered on High for 1 minute. Add 2 cups of boiling chicken stock, cook on High for 5 minutes. Stir twice during cooking. Add remaining chicken stock and cook on High for another 5 minutes. Add remaining ingredients along with asparagus and stir into risotto. Cook covered on High for 2 minutes. Stand for 5 minutes. Serve topped with extra parmesan and black pepper.

SAUSAGE & BEAN STUFFED CAPSICUMS

Serves: 4

Ingredients:

250 g	thin Italian sausages
1	small onion, chopped
2 tablespoons	tomato paste
1 tablespoon	chopped parsley
440 g	red kidney beans, drained
½ cup	cooked long grain rice
4	medium red capsicum
¼ cup	tomato paste, extra
1 tablespoon	grated Parmesan cheese

Method:

Place sausages onto a paper towel lined dinner plate. Cook on medium high for 2 minutes, turn and cook for a further 2 minutes. Set aside. Place onion and tomato paste into a medium microwave safe bowl. Cook uncovered on High for 2 minutes. Remove skins from sausages and cut sausages into 1cm slices. Stir through onion mixture along with parsley, beans and rice. Remove tops from capsicum. Take out the seeds and white membrane and discard. Fill capsicum with stuffing mixture. Place into a shallow sided microwave safe dish. Blend together extra tomato paste with half a cup of water. Pour over and around capsicum. Cook uncovered on High for 12 to 14 minutes. Rotate halfway through cooking. Sprinkle each capsicum with Parmesan and cook on High for a further 2 minutes.

Tip: substitute any thin sausages

Freeze leftover rice then defrost on High for 2 minutes per cup

Cooking Pasta by Micro power

Follow directions in chart for recommended dish size, amount of water and cooking time. Boil water, with 1 teaspoon salt and 1 tablespoon oil. Add pasta and cook for time recommended in chart. Cook on

High. Test pasta for desired cooking before adding more time. Slightly undercook pasta that will be heated again in casserole. Stir and let stand, uncovered, 5 minutes.

ITEM	CONTAINER	AMOUNT OF BOILING WATER	APPROX. TIME TO COOK PASTA on High UNCOVERED (in minutes)	STANDING TIME (in minutes)
Dried Fettuccine (250 g)	4-litre dish	6 cups	10 to 12	5
Elbow Macaroni, shells, etc. (250 g)	3-litre dish	4 cups	12 to 14	5
Fresh Spaghetti, Fettuccine (375 g)	4-litre dish	6 cups	6 to 8	5
Dried Spaghetti (250 g)	4-litre dish	4 cups	12 to 14	5
Fresh Tortellini, Ravioli (250 g)	4-litre dish	4 cups	7 to 9	5
Fresh Gnocchi (375g)	4-litre dish	6 cups	6 to 8	5

COOKING PASTA BY AUTO COOK A

- **Minimum weight 150g / Maximum weight 500g**
- Suitable for cooking pasta such as spaghetti, fettucine, macaroni, penne, spiral etc.
- See chart below for dish size and quantities.

To Operate:Auto Menu
(1-5)

Press 5 times to select Pasta, rotate the **Time/Weight** Dial to select the desired weight, then press **Start**.

- Place pasta in an appropriate size dish with boiling water. Use the following as a guide:

Pasta	Boiling Water	Dish Size
150 g	4 cups	3 litre
250 g	5 cups	3 litre
350 g	6 cups	4 litre
500 g	8 cups	4 litre

- During cooking, the oven will 'beep' and prompt you to stir halfway through the cooking time.
- At the end of the cooking time, let stand, covered, for 5 to 10 minutes, if required. Then drain.

PENNE PUTTANESCA

Serves: 4

Ingredients:

500 g	Penne Pasta
2 litres	boiling water
1 tablespoon	olive oil
3	cloves garlic, crushed
1 teaspoon	dried chilli flakes
1 kg (approx 5)	tomatoes, roughly chopped
200 g	kalamata olives, pitted
8	anchovy fillets, drained and chopped
1/3 cup	capers, drained and rinsed
1/3 cup	flat leaf parsley, chopped
2 tablespoons	finely shredded basil leaves

Method:

Place pasta and boiling water into a 4-litre dish. Stir and cook on High for 12 to 14 minutes or until tender. Drain and set aside. Place oil and garlic into a 2 litre dish and cook on High for 1 minutes. Stir in chilli and tomatoes. Cover and cook on High for 5 minutes, stir halfway through cooking. Add remaining ingredients and cook on High for a further 10 minutes or until tomatoes break down and sauce has thickened. Stir sauce into pasta. Cover and cook on High for 2 to 3 minutes to heat through. Season and serve topped with extra basil leaves or parsley.

CREAMY SUN-DRIED TOMATO PENNE A

Serves: 4

Ingredients:

250 g	penne
5 cups	boiling water
1/2 cup	sun-dried tomatoes in oil, drained
1 cup	basil leaves
1/4 cup	toasted pinenuts
1/3 cup	grated parmesan cheese
300 ml	cream
1/2 cup	sliced ham
1/4 cup	grated parmesan cheese, extra

Method:

Place pasta and water in a 4-litre casserole dish. Cook on High for 14 to 16 minutes, or cook by **Auto Cook**. While pasta is cooking, prepare sauce. Place all ingredients except ham and extra parmesan cheese into a food processor. Process until smooth. Drain pasta and add sauce. Serve topped with ham and extra parmesan cheese.

To cook by Auto Cook:Auto Menu
(1-5)

Prepare as above. Press 5 times to select Pasta, rotate the **Time/Weight** Dial to select 250 g, then press **Start**.

SPAGHETTI WITH CHILLI TOMATO SAUCE A

Serves: 4

Ingredients:

250 g	spaghetti
4 cups	boiling water
1 tablespoon	olive oil
1	onion, finely chopped
2	cloves garlic, crushed
425 g	crushed tomatoes
2 teaspoons	crushed chillies
2 tablespoons	fresh chopped basil
1 teaspoon	pepper

Method:

Place spaghetti and water in a 3-litre casserole dish. Cook on High for 12 to 14 minutes. Stand, covered, for 2 minutes. Drain. Place oil, onion and garlic in a 4-cup jug. Cook on High for 1 to 2 minutes. Add tomatoes, chillies, basil and pepper. Stir until combined. Cover and cook on Medium-High for 10 to 15 minutes, stirring halfway through cooking. Serve with spaghetti.

MACARONI AND CHEESE

Serves: 4 to 6

Ingredients:

40g	butter
1	onion, finely chopped
2 tablespoons	flour
2 cups	milk
1 cup	grated tasty cheese
6 cups	cooked macaroni, drained well
1/2 cup	extra grated tasty cheese
	paprika

Method:

Place butter and onion in a 2-litre casserole dish and cook on High for 3 to 4 minutes. Add flour, mix well and cook on High for 1 minute. Blend in milk and cook on High for 4 to 5 minutes, stirring halfway through cooking. Add cheese to sauce. Place macaroni and sauce in a 3-litre casserole dish. Mix well. Top with extra cheese and sprinkle with paprika. Cook on High for 6 to 8 minutes.

Note: Macaroni can be cooked using Auto Cook function.

Cooking Dried Noodles by Micro power

Follow directions in chart recommended dish size, amount of water and cooking time. Add 1 tablespoon of oil to water to prevent noodles from sticking together. Add noodles and cook for time recommended in chart. Cook noodles on HIGH. Test

noodles for desired cooking before adding extra time. Slightly undercook noodles that will be cooked again in a stir-fry or recipe. Always drain noodles immediately after cooking or they may overcook on standing.

ITEM	CONTAINER	AMOUNT OF BOILING WATER	APPROX. TIME TO COOK NOODLES on High UNCOVERED (in minutes)	INSTRUCTION
2 minutes noodles (85 g)	1-litre	500 ml	2 to 3	drain immediately
Long Life Asian Noodles (250 g)	3-litre	1 litre	5 to 6	drain immediately
Rice Vermicelli (125 g)	2-litre	1 litre	3 to 4	drain immediately

TERIYAKI TOFU VEGETABLE NOODLES

Serves: 4

Ingredients:

1 tablespoon sesame oil
 350 g firm tofu, diced
 1 onion, cut into petals
 300 g stir fry vegetables
 1 tablespoon hoisin sauce
 1 tablespoon teriyaki sauce
 85 g 2 minute noodles
 2 cups boiling water

Method:

Place oil, tofu and onion in a 3-litre dish and cook on High for 2 to 3 minutes. Add vegetables and sauces and cook on High for 3 to 4 minutes, stirring once during cooking. Place noodles and water in a 2-litre bowl and cook on High for 2 minutes. Stir and drain. Toss noodles through tofu and vegetables and serve.

HONEY SOY CHICKEN AND NOODLES A

Serves: 4

Ingredients:

500 g chicken fillets, sliced
 1/4 cup soy sauce
 2 tablespoons honey
 2 teaspoons minced garlic
 2 cups finely sliced vegetables
 400 g udon noodles
 1/2 cup boiling water

Method:

Combine chicken, soy, honey and garlic in a 2-litre bowl for 30 minutes. Cook chicken on Medium-High for 4 to 5 minute, stirring once during cooking. Add vegetables and cook on High for 2 to 3 minute. Place noodles and water in a bowl cover with plastic wrap cook on Medium-High for 1 to 2 minutes. Drain. Toss noodles in with chicken mixture and serve.

SATAY BEEF WITH NOODLES A

Serves: 4

Ingredients:

500 g rump steak, sliced
 1 onion, sliced
 1 teaspoon crushed garlic
 1/2 cup crunchy peanut butter
 1/4 cup sweet chilli sauce
 2/3 cup coconut milk
 2 tablespoons lemon juice
 1 teaspoon sugar
 2 green onions, sliced
 500 g fresh Singapore noodles
 1/2 cup boiling water

Method:

Place steak, onion and garlic in a 3-litre casserole dish cook on High for 2 to 2 1/2 minutes. Add remaining ingredients except green onions and noodles and stir until combined. Cook on High for 6 to 8 minutes. Stirring halfway through cooking. Place noodles with water in a 2.5-litre dish cover and cook on Medium-High for 2 to 3 minutes. Drain and rinse under cold water. Drain well. Toss beef mixture through noodles and top with green onions. Cook on HIGH for 1 to 2 minutes.

Cakes, Desserts and slices can successfully be cooked in the microwave oven if a few simple rules are followed see individual recipes for instructions.

Cooking Cakes by Micro power

- The texture of cakes cooked in the microwave oven is not the same as cakes cooked in a conventional oven, but it is a convenient way of cooking cakes.
- Do not use metal cake tins. Plastic dishes and pyrex, give the best results when cooking cakes. Grease the dish and line with paper towel or bake paper to absorb excess moisture.
- Round or oval shaped dishes produce the most even cooking results. Square cakes may need the corners shielded with foil to prevent overcooking.
- Choose light coloured cakes that can be iced or substitute brown sugar for white sugar and sprinkle the top of cake with spices to give a darker appearance.
- Do not fill cake pans more than half full. Microwaved cakes rise substantially more than conventionally cooked cakes.
- Cakes need to be well mixed but do not over beat. Creaming with an electric mixer or food processor is not necessary. Use a fork to mix as the microwave aerates the mixture as it cooks.
- Do not cover cakes as the top will steam.
- Cakes should be removed from the oven just before they look cooked as the cooking process will finish during standing time.
- Chocolate cakes cook slightly faster than plain cakes.
- Cakes containing a large amount of whisked egg white will not cook successfully in the microwave oven.

PACKET CAKE

Ingredients:

1 packet cake mix (340 g)
Ingredients as recommended by manufacturer.

Method:

Mix cake and other ingredients with a metal spoon. DO NOT OVERBEAT. Pour into 20 cm round dish that has been lightly greased and lined with paper. Cook on Medium-High for 7 to 8 minutes. Stand and allow to cool before removing.

Variations:

- 1 tablespoon jam added to batter before cooking.
- Add 1 cup sour cream to batter and halve water suggested by manufacturer.
- Half a cup chopped nuts, $\frac{1}{4}$ cup brown sugar and 1 teaspoon cinnamon. Mix and place on base of cake dish before cooking cake.
- Melt two tablespoons honey and 30 g butter in glass jug on High 30 to 60 seconds. Pour over just baked buttercake. Sprinkle with cinnamon. Serve warm with cream or custard as a dessert or serve cold with cream as tea cake.
- A quarter cup of toasted muesli mixed with 1 tablespoon marmalade and placed in the base of the dish.

Tip: Packet cakes are best mixed by hand as the microwave will do the aerating.

Cooking Fruit by Micro Power

FRUIT - Peel, slice, chop into even sized pieces. Place in shallow heatproof dish on turntable.				
Apples - poached	500 g	High	8	Add 300 ml of water. Only half fill dish. Cover.
Apples - stewed	500 g	High	6	Only half fill dish. Cover.
Peaches - poached	500 g	High	4 - 5	Add 300 ml of water. Only half fill dish. Cover.
Pears - poached	500 g	High	6 - 7	Add 300 ml of water. Only half fill dish. Cover.
Plums - poached	500 g	High	8	Add 300 ml of water. Only half fill dish. Cover.
Plums - stewed	500 g	High	8 - 10	Add 30 ml (2 tbsp) of water. Only half fill dish. Cover.
Rhubarb - stewed	500 g	High	5	Only half fill dish. Cover.

CHOCOLATE BROWNIES

Makes: 1 x 20 cm
square slice pan

Ingredients:

125 g	butter
200 g	chocolate
1 cup	caster sugar
1 teaspoon	vanilla essence
3	eggs
1 cup	plain flour

Method:

Grease and line 20 cm square pyrex dish. Melt butter and chocolate in 2-litre dish on Medium-High for 2 minutes. Stir in sugar, vanilla essence, eggs and flour. Spread into prepared dish. Cook on Medium-High for 5 to 6 minutes. Refrigerate until cold. Cut into squares.

RHUBARB, APPLE & GINGER COMPOTE

Serves: 4

Ingredients:

300 g	rhubarb, trimmed cut to 3 cm lengths
2	apples, peeled, cored and diced
30 g	crystallised ginger, thinly sliced
½ cup	caster sugar
1	orange, grated rind and juice

Method:

Place all ingredients into a 2-litre microwave safe dish. Stir to dissolve sugar. Cook on high for 8 to 10 minutes or until fruit is softened.

ROCKY ROAD

Makes: 1 x 20 cm square slice

Ingredients:

250 g	dark or milk chocolate
40 g	butter
250 g	packet marshmallows, halved
1 cup	unsalted peanuts
1½ cups	flaked coconut
100 g	Turkish delight, chopped

Method:

Melt chocolate and butter in a large bowl on Medium for 2 to 3 minutes. Add remaining ingredients and mix well. Pour into greased 20 cm square pan. Refrigerate until set. Cut or break into pieces to serve.

CHERRY KUECHEN

Serves: 4 to 6

Ingredients:

Base:	
1 (340 g) pkt	buttercake mix
½ cup	toasted coconut
125 g	melted butter
1	egg
Filling:	
425 g	can pitted cherries, drained
Topping:	
300 ml	carton sour cream
1	egg
2 tablespoons	sugar
½ teaspoon	cinnamon

Method:

Combine cake mix, coconut, melted butter and egg. Press into 27 cm flan dish. Cook on High for 3 minutes. Arrange cherries over base. Combine sour cream, egg and sugar and pour over cherries. Sprinkle with cinnamon. Cook on Medium for 9 to 11 minutes.

MOCHA FUDGE

Makes: 64 x 2.5 cm square pieces

Ingredients:

395 g	can sweetened condensed milk
300 g	dark chocolate melts
1 teaspoon	vanilla extract
1 teaspoon	instant coffee powder
64	chocolate coated coffee beans

Method:

Grease a square (20 cm) cake pan, set aside. Place condensed milk and chocolate in a 1.5-litre microwave safe and heatproof bowl. Cook on Medium-High for 2 minutes. Stir in vanilla and coffee. Mix until well combined. Cook on Medium for 2 minutes. Stir and pour into prepared pan. Arrange coffee beans evenly over the fudge. Chill for 2 hours or until set. Cut into 2.5 cm squares to serve.

Tip:

Chocolate coated coffee beans are available from specialty coffee shops.

Hint:

To toast coconut:
Place ½ cup of coconut on a pyrex plate. Cook on HIGH for 2 to 3 minutes, stirring every minute.

MOCHA CARROT CAKE

Serves: 4 to 6

Ingredients:

1 cup	self-raising flour
1/2 teaspoon	bicarbonate of soda
1/2 cup	caster sugar
1/2 cup	crushed pineapple
1 cup	grated carrot
3/4 cup	chopped pecan nuts
60 g	chocolate
2	eggs
1/3 cup	oil

Icing

60 g	cream cheese
20 g	butter
1 1/2 cups	icing sugar
1 tablespoon	lemon juice
1/4 cup	chopped pecan nuts

Method:

Place flour, bicarbonate of soda, sugar, pineapple, carrot and pecan nuts in a bowl. Place chocolate into a small bowl and cook on Medium for 40 to 60 seconds. Stir halfway through. Add melted chocolate, eggs and oil to flour mixture. Mix until well combined. Grease a microwave safe ring dish and cook on Medium-High for 6 to 8 minutes. Let stand, covered, for 5 minutes before turning out to cool. Beat together all icing ingredients except pecan nuts. Spread icing over cooled cake and sprinkle with pecan nuts.

CHOCOLATE SELF SAUCING PUDDING

Serves: 4

Ingredients:

1 cup	self raising flour
1 tablespoon	cocoa powder
1/3 cup	caster sugar
1/2 cup	milk
1 teaspoon	vanilla essence
100 g	chocolate
30 g	butter
3/4 cup	brown sugar
2 tablespoons	cocoa, extra
3/4 cup	water

Method:

Sift flour and cocoa into a 2-litre bowl. Add sugar, milk and vanilla essence. Mix well. Place chocolate and butter in a 2-cup pyrex jug and cook on Medium-High for 1 to 2 minutes. Stir and add to mixture. Mix well. Spread mixture into base of a 2-litre casserole dish. Combine brown sugar, cocoa and water in a 2-cup jug. Pour evenly over pudding. Cook on High for 4 to 6 minutes.

STEAMED JAM PUDDING

Serves: 4

Ingredients:

2 tablespoons	jam
100 g	butter
2/3 cup	caster sugar
2	eggs
3/4 cup	self raising flour
1/4 cup	milk

Method:

Spoon jam into bottom of 2-litre pyrex dish. Cream butter and sugar in a separate bowl until light and fluffy. Add eggs (one at a time), beating well after each addition. Fold in flour alternately with milk. Mix until well combined. Pour mixture over jam. Smooth top and cook on High for 6 to 7 minutes. Let stand, covered, for 5 minutes before serving.

BREAD AND BUTTER PUDDING

Serves: 4 to 6

Ingredients:

1/3 cup	sultanas
1/4 cup	rum
70 g	butter, softened
10	slices fruit loaf
4	eggs
1 1/3 cups	milk
300 ml	cream
1/3 cup	brown sugar

Method:

Grease a 1.2 litre microwave oven safe dish. Combine sultanas and rum in a small bowl. Heat on High for 1 minute. Set aside. Butter both sides of all bread slices. Remove the crusts and cut into triangles. Beat together eggs, milk and cream, add liquid from drained sultanas. Layer one third of the bread evenly over the base of the greased dish. Sprinkle with half the sultanas and one third of the brown sugar. Repeat with another layer of bread, sultanas and brown sugar and top with the remaining bread. Pour about two thirds of the egg mixture over the bread and allow to stand for 20 minutes until the liquid is absorbed. Pour over the remaining egg mixture and sprinkle with brown sugar. Elevate on a microwave safe rack and cook on Medium-Low for 30 to 35 minutes. Allow to stand for 10 minutes before serving with cream or ice cream.

QUICK MIX CHOCOLATE CAKE

Serves: 4 to 6

Ingredients:

1 cup	self-raising flour
1 cup	caster sugar
2 tablespoons	cocoa
3 tablespoons	butter, softened
2	eggs
1/3 cup	milk

Method:

Sift all dry ingredients into a bowl. Add butter, eggs and milk. Beat with wire whisk for 1 to 2 minutes. Grease a 2-litre plastic ring mould and line with paper towel. Pour mixture into mould and cook on Medium-High for 5 to 7 minutes. Stand, covered, for 5 minutes before turning out. Cool on wire rack.

Tip: To soften butter cook on Medium for 10 to 20 seconds.

CINNAMON POACHED PEARS

Serves: 4

Ingredients:

1/2 cup	water
1/4 cup	caster sugar
1/2 teaspoon	cinnamon
4	pears, peeled and sliced

Method:

Combine water, caster sugar and cinnamon in a 1-litre jug. Cook on High for 2 minutes. Place the pears in a 2-litre dish. Pour over syrup and cover. Cook on High for 6 to 8 minutes.

BANANA LOAF

Serves: 4 to 6

Ingredients:

90 g	butter
3/4 cup	brown sugar
1	egg
2	ripe bananas, mashed well
3/4 cup	grated carrot
1 1/2 cups	self-raising flour
1/3 cup	milk

Method:

Cream butter and sugar until light and fluffy. Add egg and beat well. Add banana and carrot. Add sifted flour and milk to mixture alternately. Mix until well combined. Grease and line with grease proof paper, 20 cm x 10 cm loaf dish. Pour batter into dish and cook on Medium for 9 to 11 minutes. Stand, covered, with plastic wrap on wire rack to cool.

Tip: To prevent corners from overcooking, cover ends carefully with foil.

HINT:**TO MELT CHOCOLATE:**

Place 100 g broken chocolate in a 4-cup glass jug and heat on Medium for 1 to 2 minutes. As chocolate holds its shape after heating, stir and stand before adding extra cooking time.

APPLE CRUMBLE

Serves: 4

Ingredients:

780 g	can pie apples
1/2 cup	rolled oats
1/4 cup	plain flour
1/2 cup	desiccated coconut
1/2 cup	brown sugar
1 teaspoon	cinnamon
60 g	butter

Method:

Place apples in the base of 1-litre casserole dish. Place remaining ingredients (except butter) in mixing bowl. Melt butter in 2-cup jug on High for 40 to 60 seconds. Combine melted butter with dry ingredients and mix well. Spread evenly over apples. Cook on High for 5 to 8 minutes.

PEACH AND MUESLI CRUMBLE

Serves: 6 to 8

Ingredients:

80 g	butter
1/2 cup	flour
1/4 cup	caster sugar
1 1/2 cups	toasted muesli
1/2 cup	shredded coconut
1/2 teaspoon	cinnamon
810 g	can peach slices, drained

Method:

Place butter in a 2-litre jug. Cook on Medium for 1 minute. Add flour, sugar, muesli, coconut and cinnamon, stir until combined. Place peaches into a 1-litre casserole dish. Place crumble mixture on top of peaches and cook on High for 10 to 12 minutes. Serve with cream or ice cream.

COCONUT CREAMED RICE

Serves: 4

Ingredients:

1 cup	arborio rice
300 ml	coconut milk
20 g	unsalted butter
1/2 cup	sugar
100 ml	coconut milk, extra to serve
1	banana, to serve
1/2 cup	shredded coconut, toasted

Method:

Wash and drain rice. Place rice, 300ml of coconut milk, 300ml water, butter and sugar into a 2.5L deep microwave safe bowl or jug, stir to combine. Microwave uncovered on High for 21 minutes, stirring every 7 minutes. Remove and stir well, stand for 5 minutes.

Note: Rice will absorb excess liquid on standing. Serve warm in individual bowls drizzled with extra coconut milk, banana slices and shredded coconut.

FRUIT MINCE

Serves: 4

Ingredients:

250 g	mixed dried fruit
440 g	crushed pineapple and juice
1	cooking apple peeled, cored and grated
1 cup	brown sugar
1 tablespoon	brandy
1 teaspoon	nutmeg
1 teaspoon	cinnamon
1 tablespoon	cornflour
¼ cup	water

Method:

Combine all ingredients (except cornflour and water) in a 2-litre casserole dish. Cook on Medium-High for 3 to 5 minutes. Blend cornflour with water and stir into fruit mixture. Cook on High for 4 to 6 minutes. Stir. Cool. Bottle and seal or use immediately.

INDIVIDUAL CHRISTMAS PUDDING

Makes: 8

Ingredients:

100 g	sultanas
150 g	raisins
50 g	craisins
100 g	dates, chopped
100 g	dried figs, chopped
50 g	glace ginger, chopped
½ cup	brandy
125 g	butter
¾ cup	firmly packed brown sugar
2	eggs
½ teaspoon	cinnamon
½ teaspoon	mixed spice
½ teaspoon	nutmeg
½ cup	plain flour
½ cup	pie apple
¾ cup	fresh breadcrumbs
1 tablespoon	golden syrup
1 tablespoon	parisienne essence

Method:

Place all dried fruits and brandy into a 2-litre bowl. Mix and cook uncovered on Medium-Low for 10 minutes. Stir halfway through cooking. Cool. Beat butter and sugar in a large bowl with an electric mixer until light and fluffy. Add eggs, one at a time, beating between each addition. Stir in cooled fruits, then remaining ingredients. Grease 4 x 200 ml microwave safe cups. Place half a cup of mixture into each cup, pushing mixture in firmly. Smooth over the top of puddings with the back of a spoon. Place cups evenly around the edge of the microwave turntable and cook uncovered on Medium-Low for 20 minutes. Stand for 5 minutes before turning out. Repeat with remaining mixture. Serve with cream or custard.

MINCE PIES • CAUTION

Take care not to overheat mince pies, otherwise burning can occur due to the high fat and sugar content of the filling. Check the temperature of the filling before consuming to avoid burning your mouth. REMEMBER even if the pastry is cold to the touch, the filling will be piping hot and will warm the pastry through.

CHOCOLATE PÂTÉ

Makes 24 x 8 cm loaf tin

Ingredients:

300 g	dark chocolate
400 g	condensed milk
1 cup	brazil nuts
½ cup	hazel nuts
⅓ cup	glace cherries
½ cup	sultanas

Method:

Break chocolate into pieces and place with condensed milk in a 2-litre dish. Cook on Medium-High for 3 to 5 minutes, stirring twice during cooking. Fold through nuts and fruits. Line a 24 x 8 cm loaf tin with foil and pour in the mixture. Chill for several hours or until set. Turn out and serve thinly sliced.

STIRRED CUSTARD

Makes: Approximately 400 ml

Ingredients:

3 tablespoons	sugar
2 tablespoons	custard powder
1½ cups	milk
2	egg yolks, lightly beaten
1 teaspoon	vanilla essence

Method:

Combine sugar and custard powder in a 4-cup jug. Gradually stir in milk until smooth. Cook on Medium for 4 to 5 minutes, stirring halfway through cooking. Add egg yolks and mix well. Cook on Medium for further 30 to 60 seconds. Add vanilla, stir well and serve.

BRANDY SAUCE

Makes: 1½ cups

Ingredients:

2 tablespoons	butter
2 tablespoons	cornflour
3 tablespoons	sugar
2 tablespoons	golden syrup
1 cup	milk
¼ cup	brandy

Method:

In a 1-litre pyrex jug melt butter on High for 20 to 30 seconds. Blend in cornflour, sugar and golden syrup and cook on High for 50 to 60 seconds. Add milk gradually and cook on Medium 3 to 4 minutes. Stirring halfway through cooking. Stir in brandy. Serve hot with fruit or Christmas pudding.

STRAWBERRY ROULADE

Serves: 4

Dish: Swiss roll tin 23 x 33 cm (13" x 9"), greased and lined with baking parchment

Oven Accessory: low wire rack

Ingredients:

4 medium egg whites
200 g caster sugar
1 teaspoon cornflour
1 teaspoon malt vinegar
1 teaspoon vanilla extract
40 g flaked almonds

Filling:

300 ml double cream, softly whipped
250 g strawberries, sliced

Method:

Preheat the oven on **CONVECTION 150 °C**. Whisk the egg whites until stiff but not dry.

Slowly whisk in the sugar until the mixture is thick and glossy. Blend the cornflour, vinegar and vanilla extract to a smooth paste, in a separate bowl and then whisk into egg whites.

Spoon into the tin and gently level the top. Sprinkle with flaked almonds. Place on low wire rack and cook on **CONVECTION 150 °C** for 30 mins. Remove meringue from oven and cover with damp greaseproof paper. After 10 minutes remove greaseproof paper from the meringue and turn out onto a sheet dusted with icing sugar and carefully peel off the lining paper. Spread cream all over the meringue and scatter the strawberries on top. Roll up the roulade from one of the short edges using the baking parchment paper to help you. Chill in the fridge for 30 mins and then lightly dust with icing sugar before serving.

CHOCOLATE CHEESECAKE

Dish: bowl, 23 cm (9") flan tin, greased

Accessory: no accessory then low wire rack

Ingredients:

100 g butter
225 g digestive biscuits, crushed
225 g plain chocolate
2 tablespoons milk
700 g soft cheese
175 g soft brown sugar
3 medium eggs
1 teaspoon vanilla essence

Method:

Put butter in bowl. Place on base of oven and heat on **HIGH MICROWAVE** for 40-50 secs. Stir in biscuits and press into base of flan. Melt chocolate with milk on **HIGH MICROWAVE** for 2 mins. Preheat oven on **CONVECTION 150 °C**. Mix all the remaining ingredients and stir in chocolate. Pour over biscuit base. Place tin on low wire rack and cook on **CONVECTION 150 °C** for 30-40 mins.

CELEBRATION CAKE

Dish: 20 cm (8") round tin, greased and lined

Oven Accessory: low wire rack

Ingredients:

225 g butter or margarine
225 g dark muscovado sugar
225 g plain flour
4 eggs, beaten
50 g ground almonds
100 ml sherry
75 g candied peel
75 g glace cherries, roughly chopped
250 g currants
250 g raisins
100 g pecan nuts, broken into pieces
finely grated zest of 1 lemon
1½ teaspoons mixed spice
½ teaspoon vanilla extract
½ teaspoon baking powder

Method:

Preheat oven on **CONVECTION 140 °C**. Prepare the tin by lining with a double layer of greaseproof paper on the inside and tie a double band of brown paper around the outside.

Cream the butter and sugar until pale and fluffy. Add the eggs one at a time, beating well after each addition. Fold in half the flour using a metal spoon, then fold in the rest.

Stir in the almonds. Mix in the sherry, and then add the peel, cherries, raisins, currants, nuts, lemon zest, spice and vanilla. Stir in the baking powder. Spoon mixture into the tin and spread evenly, removing all air pockets. Make a small dip in the centre. Place tin on low wire rack and cook on **CONVECTION 140 °C** for 2-2¼ hrs. until a skewer inserted in the middle comes out clean. Leave cake to cool in tin. When completely cold wrap well in cling film and foil to store until ready to decorate. The cake will keep for several months.

SWISS ROLL

Dish: 30 x 25 x 3.5 cm

(12" x 8" x 1½") tin lined with parchment paper

Oven Accessory: low wire rack

Ingredients:

3 large eggs, beaten
125 g caster sugar
100 g plain flour
25 g cocoa powder Filling
225 g fresh raspberries
284 ml double cream icing sugar to dredge

Method:

Preheat oven on **CONVECTION 200 °C**.

Whisk eggs and sugar together in a heatproof bowl until blended. Stand bowl over hot water and continue to whisk eggs and sugar until pale and creamy, and mixture leaves a trail on the surface when the whisk is lifted. Remove from hot water and whisk until cool and thick.

Carefully fold in half of the sifted flour, then fold in the other half. Fold in 15ml (1tbsp) of hot water. Tip the tin to allow mixture to run into corners. Turn halfway. Place tin on low wire rack and cook on **CONVECTION 200 °C** for 8-9 mins.

Place sheet of greaseproof paper on a damp tea towel and dredge paper with caster sugar. Quickly turn the Swiss roll out onto the greaseproof and carefully remove the baking parchment. Roll when slightly cooled, then unroll fill with cream and fruit and re-roll.

MILLIONAIRES SHORTBREAD

Dish: Bowl 28 x 17 cm 11" x 7" cake tin, greased and lined

Oven Accessory: low wire rack then no accessory

Ingredients:

Shortbread

225 g	plain flour
75 g	caster sugar
175 g	unsalted butter Caramel
200 g	butter
397 g	unsweetened condensed milk
4 tablespoons	golden syrup Topping
300 g	milk or dark chocolate in chunks
2 tablespoons	vegetable oil

Method:

Preheat oven on **CONVECTION 170 °C**. Place flour and sugar in a bowl and rub in butter. Press dough into tin. Prick shortbread with a fork and cook on **CONVECTION 170 °C** for 5 mins, then reduce temperature to **150 °C** for 30-40 mins. Remove from oven when shortbread has a golden colour and leave to cool in tin. Remove low wire rack. Place butter for caramel in a bowl and melt on **HIGH MICROWAVE** for 1-2 mins. Add condensed milk and syrup. Whisk until thoroughly mixed and cook on **HIGH MICROWAVE** for 8 mins. Stir mixture every minute to prevent burning. Caramel should have thickened in this time. Pour caramel over shortbread. Place chocolate and oil in a large bowl and melt on **HIGH MICROWAVE** for 1-2 mins. Stir. Pour chocolate on caramel and chill.

FRUIT SCONES

Makes 10

Dish: baking sheet 30 x 21.5 cm (12" x 8"), greased

Oven Accessory: low wire rack

Ingredients:

225 g	self-raising flour pinch salt
1 teaspoon	baking powder
50 g	butter
25 g	caster sugar
50 g	sultanas
5 tablespoons	milk beaten egg to glaze

Method:

Preheat oven on **CONVECTION 210 °C**. Sift the flour, salt and baking powder together. Rub in fat until the mixture resembles fine breadcrumbs. Add sugar and sultanas.

Make a well in the centre and stir in enough milk to form a soft dough. Knead lightly. Pat out to 2 cm ($\frac{3}{4}$ " thick and cut into 10 rounds with a 5 cm (2") cutter. Place on baking sheet and brush with beaten egg. Place on low wire rack and cook on **CONVECTION 210 °C** for 15 mins. or until well risen and golden brown.

FLAPJACK

Dish: bowl, 30 x 20 x 3.5 cm (12" x 8" x $\frac{1}{2}$ ") tin lined with lightly buttered greaseproof paper

Oven Accessory: no accessory then low wire rack

Ingredients:

250 g	butter
275 g	golden syrup
75 g	light muscovado sugar
425 g	porridge oats

Method:

Place the butter, syrup and sugar into bowl and melt on **MEDIUM MICROWAVE** for 4-5 mins. Pre-heat the oven on **CONVECTION 180 °C**. Stir the oats into the butter and press the mixture into the tin. Place tin on low wire rack and cook on **CONVECTION 180 °C** for 20-25 mins. Leave to cool in the tin for 5 mins. then mark into 18 pieces. Allow to cool completely before removing from the tin.

Preserving Precautions

Do not use your oven for home canning or the heating of any closed jar. Pressure will build up and the jar may explode. In addition, the microwave oven cannot maintain the food at the correct canning temperature. Improperly canned food may spoil and be dangerous to consume.

Jars and Bottles

Jars and bottles can be used to warm food to serving temperature. If the lid is removed first. Cooking should not be done in these containers since most are not heat resistant and during extended heating times, heat from food would cause cracking or breaking.

Thermometers are available for use in microwave ovens. **DO NOT USE CONVENTIONAL MERCURY TYPE CANDY OR MEAT THERMOMETERS** in food while cooking in the microwave oven.

Alternatively, a conventional meat thermometer may be used after the food is removed from the oven.

Sterilizing Jars

Jam jars can be sterilized by microwave ready for your jams. Half fill with water and heat them on HIGH power until water boils (approx.3 mins, for 2 jars). Empty and drain upside down on kitchen paper. The jars should be warm when filled with jam.

TOMATO CHUTNEY

Makes: 3 cups (750 ml)

Ingredients:

250 g	onion, finely chopped
1.5 kg	ripe tomato, skins removed and chopped
1 teaspoon	salt
1 teaspoon	paprika
	pinch cayenne pepper
150 ml	malt vinegar
175 g	sugar

Method:

Place onions in a 3-litre dish. Cover. Cook on High for 4 to 5 minutes. Add tomatoes. Cover. Cook on High for 5 to 6 minutes. Add salt, spices and vinegar. Stir well. Cook on High for 10 minutes, stirring halfway through. Add sugar, stir well and cook on Medium-High for 35 to 40 minutes. Stirring occasionally. Pour into sterilised jars and seal.

LEMON BUTTER

Makes: 1 cup (250 ml)

Ingredients:

½ cup	lemon juice
1 tablespoon	lemon rind
⅓ cup	sugar
3	egg yolks
1 tablespoon	butter
1 tablespoon	cornflour

Method:

Blend all ingredients in a 4-cup glass jug. Cook on Medium for 4 to 5 minutes, stirring every minute. Pour into hot sterilised jars and seal immediately.

LEMON LIME CORDIAL

Makes: approximately 1.5 litres of undiluted cordial

Ingredients:

10	large lemons
6	limes
4 cups	sugar
2 cups	water
2 teaspoons	citric acid

Method:

Squeeze juice from lemons and limes. Place in a 3 to 4-litre dish with the remaining ingredients. Cook on High for 8 to 10 minutes. Stir 2 to 3 minutes during this cooking time to dissolve sugar. Cook on High for 25 to 30 minutes, or until the mixture has become a syrupy consistency. Set aside to cool. Pour into bottles and seal. Store in the refrigerator and serve with cold water, soda or mineral water and fresh mint leaves if desired.

HOT COCOA

Makes: 1 cup

Ingredients:

2 teaspoons	cocoa powder
1 teaspoon	sugar
2 tablespoons	water
1 cup	milk

Method:

Combine cocoa, sugar and water in a heatproof cup. Cook on High for 10 to 15 seconds. Stir in milk. Heat on Medium-High for 1 to 2 minutes.

GINGER TEA

Serve: 2

Ingredients:

5 cm	piece ginger
1	lemon, sliced
2	teabags
1 cup	mint leaves
2 cups	water

Method:

Peel and slice ginger and place into a 2-cup jug with remaining ingredients. Heat on High for 3 to 4 minutes. Allow standing for 5 minutes to infuse. Strain and serve.

HOT LEMON AND HONEY DRINK

Makes: 1

Ingredients:

	juice of ½ lemon
1 tablespoon	honey
1 cup	water

Method:

Mix all ingredients in a 2-cup heatproof jug. Heat on High for 1 to 2 minutes. Stir well.

BASIC WHITE SAUCE

Makes: 1 cup

Ingredients:

2 tablespoons butter
 2 tablespoons flour
 salt and white pepper
 1¼ cups milk

Method:

Place butter in a 4-cup jug. Cook on High for 30 to 40 seconds. Stir in flour, salt and pepper. Gradually add milk, stirring until smooth. Cook on High for 2 minutes, stirring every minute.

Tip: For cheese sauce, stir in ½ cup grated cheese once sauce has thickened.

GRAVY

Makes: 2 cups

Ingredients:

2 tablespoons dripping or pan juice
 1 small onion, finely chopped
 2 tablespoons flour
 1 tablespoon tomato paste
 1½ cups beef stock
 salt and pepper

Method:

Place dripping or pan juices and onion in a 2-cup jug. Cook on High for 2 minutes. Add flour, tomato paste and half of the beef stock. Stir well. Cook on High for 2 minutes. Add remaining stock. Stir well and cook on High for a further 2 minutes. Season with salt and pepper. Serve with the meat of your choice.

CHEESE SAUCE

Makes: 1½ cups

Ingredients:

40 g butter
 2 tablespoons flour
 1½ cup milk
 ½ cup grated cheese

Method:

Melt butter in a 1-litre jug on High for 30 seconds. Add flour and mix well. Gradually stir in milk. Cook on High for 3 to 4 minutes. Stirring through halfway cooking. Add cheese and cook on High for a further 1 to 1½ minute. Stir and serve with vegetables of your choice.

MINT SAUCE

Makes: Approximately ¼ cup

Ingredients:

¼ cup water
 1 tablespoon sugar
 2 tablespoons brown vinegar
 2 tablespoons mint, finely chopped

Method:

Combine all ingredients in a 1-cup jug. Cook on High for 30 to 60 seconds. Stir well and serve with Roast Lamb.

HINT:**COOKING SAUCES:**

When making some sauces in the microwave oven, less liquid may be needed as less evaporation occurs with a shorter cooking time.

HOLLANDAISE SAUCE

Makes: ¾ cup

Ingredients:

60 g butter
 2 tablespoons lemon juice
 2 egg yolks
 ¼ cup cream
 ½ teaspoon mustard
 ¼ teaspoon salt

Method:

Place butter in a 2-cup jug. Cook on High for 40 seconds. Add lemon juice, egg yolks and cream. Mix well. Cook on Medium for 60 to 90 seconds. Add mustard and salt, mix until smooth. Serve with eggs, vegetables or fish dishes.

CREAMY BACON SAUCE

Makes: Approximately 300 ml

Ingredients:

1 onion, chopped
 3 bacon rashers, chopped
 1 teaspoon minced garlic
 300 ml cream
 ¼ cup Parmesan cheese
 pepper
 2 tablespoons chopped fresh parsley

Method:

Place onion, bacon and garlic in a 2-litre casserole dish. Cook on High for 4 to 5 minutes. Add cream, Parmesan cheese, pepper, parsley and stock. Mix well. Cook on High for 3 to 4 minutes. Serve with cooked Fettuccine.

RICH CHOCOLATE SAUCE

Makes: 1¼ cups

Ingredients:

200 g chocolate pieces
 300 ml cream

Method:

Combine chocolate and cream in a 1-litre jug. Cook on High for 2 minutes. Mix well. Serve over ice cream.

SWEET BERRY SAUCE

Makes: Approximately 2 cups

Ingredients:

½ cup caster sugar
 ½ cup water
 500 g berries
 2 tablespoons water
 1 tablespoon cornflour

Method:

Combine sugar and water in a 3-litre bowl. Cook on High for 2 to 3 minutes. Add berries. Cook on High for 3 to 4 minutes. Blend water and cornflour. Mix into berry sauce. Cook on High for 2 minutes. Serve hot or cold with ice cream.

To prove dough

Prove on **CONVECTION 40 °C** until doubled in size. The microwave is also useful for defrosting and warming frozen bread products, taking individual slices or items from the freezer as required.

STANDARD/WHOLE BREAD

Makes 2 loaves or 12 rolls

Dish: 2 x 450 g loaf tin, lightly greased

Oven Accessory: low wire rack

Ingredients:

450 g	strong bread flour
1	sachet dried yeast
1 teaspoon	salt
15 g	fat
275 ml	warm water

For Wholemeal bread

Use 225 g each of wholemeal and strong white bread flour.

Use 450 g granary flour.

Method:

In a large bowl, combine the flour, yeast and salt. Rub in the fat. Add the warm water then mix to a dough. Turn onto a floured surface and knead for 10 mins. Divide into two and place in the loaf tins. Cover and prove until the dough has doubled in size in a warm place or on **CONVECTION 40 °C**. Preheat the oven on **CONVECTION 220 °C**. Place the two loaf tins side by side on the low wire rack. Cook on **CONVECTION 220 °C** for 20-25 mins.

FOCACCIA

Serves: 4 to 6

Oven Accessory: greased Oven Tray in lower position

Ingredients:

450 g	strong white bread flour
1	sachets dried yeast
1 teaspoon	sugar
1 teaspoon	salt
275 ml	warm water

Topping

- 1 small red onion sliced and softened with 5 ml (1 tsp) olive oil and 5ml (1 tsp) balsamic vinegar. (Do this in a bowl covered in cling film in the microwave for 1-2 min).
- 30 ml (2 tbsp) chopped black or green olives.
- 2 chopped cloves of garlic, sea salt and cracked black pepper corns.
- 30 ml (2 tbsp) sundried tomatoes, chopped

Method:

In a large bowl, combine the flour, yeast, sugar and salt. Gradually add the warm water until you have a soft dough. Turn onto a floured surface and knead for 10 mins. Roll and press the dough into a 40 cm x 30 cm rectangle (15" x 12") and place on Oven Tray. Cover and prove until the dough has doubled in size in a warm place or on **CONVECTION 40 °C**. Dimple the surface of the dough. Add one of the suggested toppings and drizzle with olive oil. Preheat oven on **CONVECTION 220 °C**. Place Oven Tray in oven and cook on **CONVECTION 220 °C** for 10-15 mins.

SUN DRIED TOMATO ROLL

Makes 6 rolls

Oven Accessory: greased Oven Tray in lower position

Ingredients:

250 g	strong bread flour
1 teaspoon	sachet dried yeast
1 teaspoon	salt
25 g	sun-dried tomatoes, roughly chopped
3 tablespoons	olive oil
75 ml	passata
75 ml	warm water
1 teaspoon	olive oil

Method:

In a large bowl, combine the flour, yeast and salt and stir in the tomatoes. Add the oil, passata and enough warm water to form a soft dough. Turn onto a floured surface and knead for 10 mins. Divide dough into 6 and place on Oven Tray. Cover and prove until the dough has doubled in size in a warm place or on **CONVECTION 40 °C**. Preheat the oven on **CONVECTION 220 °C**. Glaze rolls with olive oil. Place the Oven Tray in oven and cook on **CONVECTION 220 °C** for 15- 20 mins.

PIZZA ALLE CIPOLE

Serves: 4 to 6

Dish: bowl

Oven Accessory: Oven Tray greased in lower position

Ingredients:

250 g	strong bread flour
1 teaspoon	sachet dried yeast
½ teaspoon	salt
2 teaspoons	olive oil
150 ml	warm water

Topping

1	red onion, cut into rings
2	cloves garlic, crushed
400 g	tomatoes on the vine
12	pitted black olives
16	capers
2 tablespoons	olive oil
1 teaspoon	chilli flakes
1 teaspoon	mixed herbs
12	basil leaves
150 g	mozzarella, grated

Method:

In a large bowl combine the flour, yeast and salt. Add the oil and gradually add enough warm water until you have a soft dough. Turn onto a floured surface and knead for 10 mins. Roll out to a 25 cm (10") circle. Cover, and prove until the dough has doubled in size in a warm place or on **CONVECTION 40 °C**. Place the onion and garlic in a bowl on glass turntable and cook on **HIGH MICROWAVE** for 3 mins. Add the tomatoes, olives, capers and olive oil. Cook on **HIGH MICROWAVE** for 5 mins. Preheat oven on **CONVECTION 230 °C**. Spread the topping over the dough and sprinkle with remaining ingredients. Place on Oven Tray and cook on **CONVECTION 230 °C** for 15-20 mins.

Tip: Other toppings to try are: salami, mozzarella and black olives; beef tomatoes, mozzarella and pesto; mozzarella, yellow pepper and mushroom; anchovy, black olives, capers and mozzarella.