

# *Sunbeam*

**FRESH PROTECT™ AIR PURIFIER**

**User Guide**

SAP1000WH



## Contents

<b>Sunbeam's Safety Precautions</b>	<b>1</b>
<b>Get to know your Air Purifier</b>	<b>2</b>
<b>Control Panel &amp; Features</b>	<b>3</b>
<b>Features of your Air Purifier</b>	<b>4</b>
<b>Getting Started</b>	<b>5</b>
<b>Operating Instructions</b>	<b>5</b>
<b>Care and maintenance</b>	<b>6</b>
<b>How to replace the True HEPA Filter</b>	<b>6</b>
<b>How to Replace the UV Light Bulb</b>	<b>7</b>
<b>Troubleshooting and Support</b>	<b>8</b>
<b>Warranty Information</b>	<b>9</b>

## Important Instructions - retain for future use

تأكد من تفهم احتياطات السلامة المذكورة اعلاه

請務必理解上述的安全預防措施。

Assurez-vous que les précautions ci-dessus relatives à la sécurité sont bien comprises

Versichern Sie sich, dass die obenstehenden Sicherheitsmaßnahmen Verstanden werden

Βεβαιώστε πως οι παραπάνω προφυλάξεις ασφαλείας γίνονται κατανοητές

Pastikan bahwa tindakan-tindakan keselamatan seperti di atas dimengerti anda

Accertatevi che le suddette norme di sicurezza siano comprese a dovere

上記の注意事項をよくお読みになり、安全を御確認ください

Уверете се дека погоре споменатите мерки на претпазливост се добро разбрани

Asegúrese de que las precauciones de seguridad precedentes sean bien comprendidas

کاری بکنید کہ احتیاط‌های بالا حتماً درک بشوند

ต้องแน่ใจว่า ข้อควรระวังเรื่องความปลอดภัยข้างต้น เป็นที่เข้าใจกันดี

Yukarda belirtilen güvenlik önlemlerinin anlaşıldığından emin olunuz

Xin kiểm chắc rằng những biện pháp làm an toàn kể trên được hiểu rõ

## Sunbeam's Safety Precautions

When using electrical appliances, basic safety precautions should always be followed to reduce the risk of fire, electric shock, and injury to persons. These precautions include:

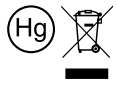
- Read all instructions before using the appliance.
- Read the maintenance instructions before opening the appliance.
- To avoid fire or shock hazard, plug the appliance directly into appropriate electrical outlet.
- If the filter is covered by a bag when shipped, remove plastic bag before use and keep away from children.
- Keep the cord out of heavy traffic areas. To avoid fire hazard, never put the cord under rugs, near heat registers, radiators, stoves, or heaters.
- To protect against electrical hazards, do not immerse the appliance or use near water or other liquids.
- This appliance is not intended for use by children or by persons with reduced physical, sensory, or mental capabilities, or lack of experience and knowledge, unless they have been given supervision or instruction concerning use of the appliance by a person responsible for their safety. Close supervision is necessary when any appliance is used near children. Children should be supervised to ensure that they do not play with the appliance. Keep the appliance and its cord out of reach of children.
- Always turn the appliance off before unplugging it.
- Always unplug the air purifier before moving or cleaning the unit, opening the filter chamber cover, changing the filters and whenever the unit is not in use. To disconnect the unit, be sure to pull the plug and not the cord.
- Never drop or insert any objects into the openings of the unit.
- Do not operate any appliance with a damaged cord or plug. If the air purifier fails to operate or the unit has been dropped or damaged in any manner, return appliance to manufacturer for examination and/or repair. Appliances that are obviously damaged must not be operated.
- Use appliance only for intended household use as described in this manual. Any other use not recommended by the manufacturer may cause fire, electric shock, or injury to persons.
- Do not use outdoors.
- Never place on a soft surface such as a bed or sofa as this could cause the unit to tip over and block the air inlet or outlet grills.
- Keep unit away from heated surfaces and open flames.
- Do not place anything on top of unit.
- Prior to cleaning or other maintenance, the appliance must be disconnected from the supply mains.
- Never use detergents, glass cleaner, furniture polish, paint thinner or other household solvents to clean any part of the appliance.
- This appliance should only be used in a room with temperatures between 10° C and 40° C.
- **WARNING:** To reduce the risk of fire or electric shock, do not use this appliance with any solid-state speed control device.
- Do not place the appliance on a walkway or where someone may trip over it. Misplacement of the appliance may cause a trip and fall.
- **CAUTION:** To prevent risk of electric shock, remove cord plug from outlet before opening appliance. To prevent risk of fire, inspect and clean equipment regularly as noted in this manual.
- This appliance contains a UV-C emitter.
- Unintended use of the appliance or damage to the housing may result in the escape of dangerous UV-C radiation.
- **⚠ UV-C radiation may, even in little doses, cause harm to the eyes and skin. Do not operate the UV-C emitter outside the appliance.**
- The appliance must be disconnected from the supply mains before replacing the UV-C emitter.
-  The lamp in the product contains Mercury. Do not place in trash. Dispose of according to local, state or federal laws.

If you have any concerns regarding the performance and use of your appliance, please visit the Sunbeam website or contact the Sunbeam Consumer Service Line. Ensure the above safety precautions are understood.

## Get to know your air purifier

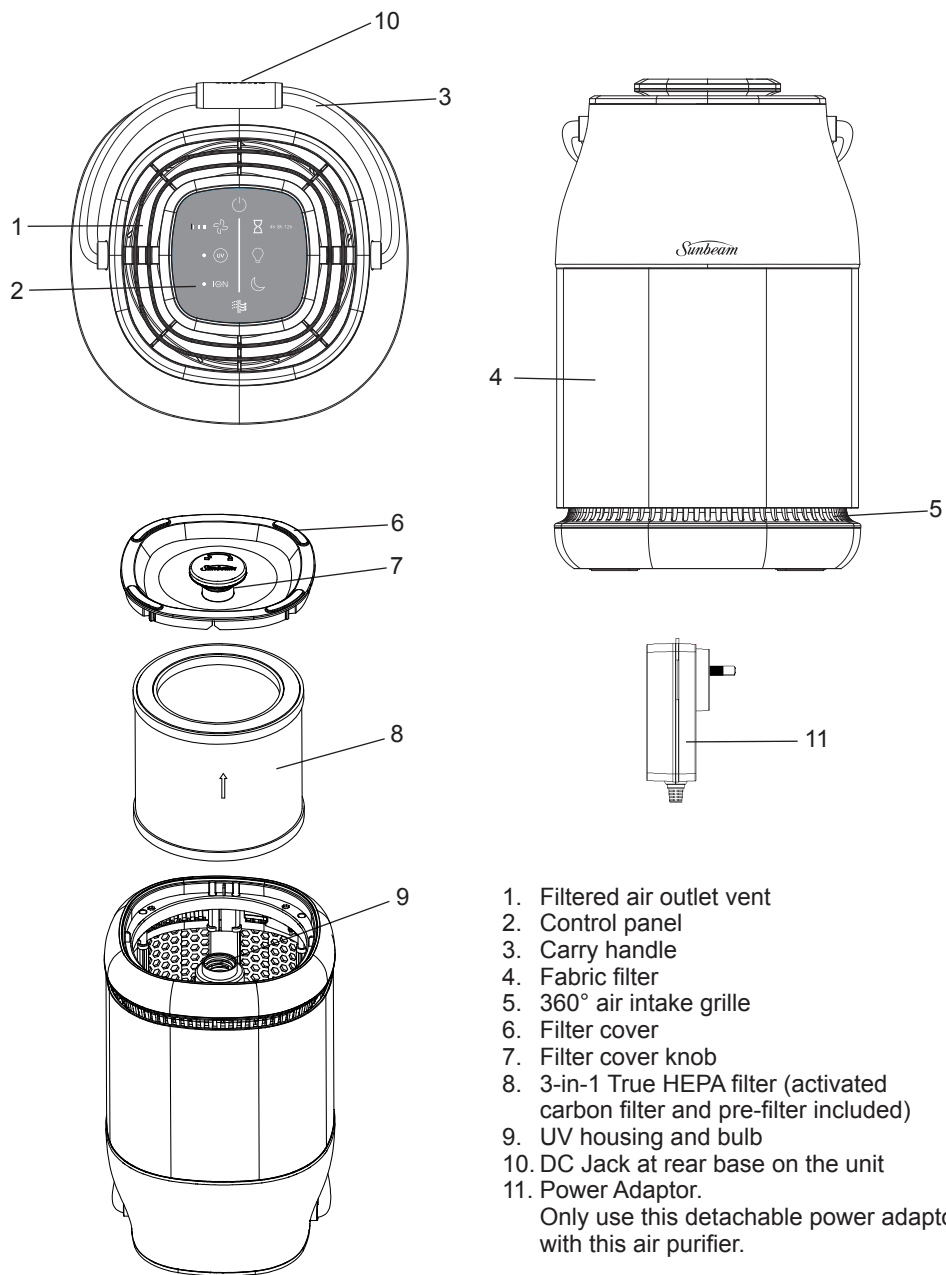

1. Filtered air outlet vent
2. Control panel
3. Carry handle
4. Fabric filter
5. 360° air intake grille
6. Filter cover
7. Filter cover knob
8. 3-in-1 True HEPA filter (activated carbon filter and pre-filter included)
9. UV housing and bulb
10. DC Jack at rear base on the unit
11. Power Adaptor.  
Only use this detachable power adaptor with this air purifier.

## Control panel and features

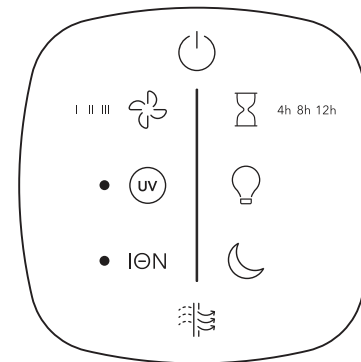

### On/Off button

Turns unit on or off.



### Filter replacement indicator

Illuminates in red when it's time to replace your filter.



### Fan speed settings

Adjusts the speeds between 1 (low), 2, 3 (high).



### Timer

Sets a timer for 4, 8 or 12 hours.



### UV-Protect™ UV Light

Turns the UV light on and off depending on your preference.



### Night light

Turns the night light on and off.



### Ioniser

Turns the ioniser on and off depending on your preference.



### Night mode

Dims the display lights so you can sleep comfortably.

## Features of your air purifier

### True HEPA filter

Your air purifier features a True HEPA filter which removes up to 99.97% of airborne dust and pollen as small as 0.3 microns and helps reduce smoke, mould spores and pet dander from the air passing through the filter.

### Pre-filter

The pre-filter captures large particles from dust, hair, pet dander to help extend the filter's efficiency and life.

### Activated carbon filter

Designed to reduce and neutralize odours, vapours and gases from cooking, smoke, chemicals, pets, and other unwanted scents.

### Fabric filter

The vacuum-friendly outer fabric catches larger particles, extending the life of the main filter.

### Ioniser

This appliance has an ioniser feature which releases negative ions into outgoing filtered air to help the air purification process.

### What are ions?

Ions are tiny particles that carry a positive or negative charge. They exist naturally around us in the air, water, and ground. Both positive and negative ions are colourless, odourless, and completely harmless.

### How does the ioniser work?

Negative ions help air purification by attaching themselves to very small airborne particles in the room. These particles take on a negative charge and may join with positively charged particles such as dust, pollen, smoke, and pet dander to form larger particles. The larger particles are then more easily captured by the filter system.

### Important notes:

Your ioniser may produce an occasional popping or cracking sound. This is normal and occurs when a small buildup of ions is discharged.

After extended use, you may notice dust around the grilles or panels.

- This is caused by negative ions exiting the air outlet, evidence of the ioniser's air cleaning effectiveness.
- You can remove the dust with a soft brush or clean, damp cloth. Larger particles may be attracted to positively charged surfaces throughout the home, like walls or floors.
- This may occur more frequently when the filter is nearing the end of its useful product life and unable to capture as many charged particles.
- Excessive amounts of pet dander, dust, or smoke may decrease the life expectancy of the filters and interfere with the ionisation process.

## PRODUCT SPECIFICATIONS

CADR	Smoke 191m <sup>3</sup> /h Dust 193m <sup>3</sup> /h Pollen 205m <sup>3</sup> /h	Noise level on high speed	59 dB max
Fan speeds	3	Power consumption	38W







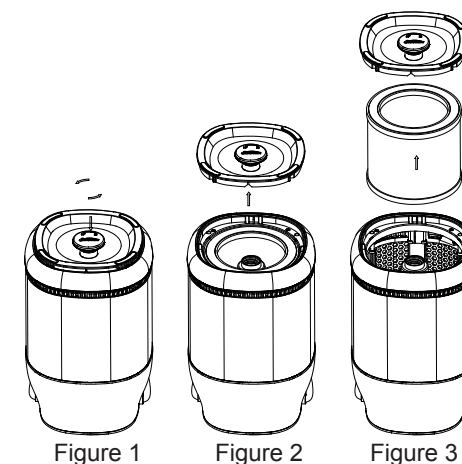





## Getting started

### Installing the True HEPA filter

1. Turn OFF and unplug the air purifier.
2. Locate the filter cover on the bottom of the unit.
3. Rotate the knob counterclockwise to remove the cover and expose the filter (Figure 1-2).
4. Remove the plastic bag from the filter and re-insert the filter (Figure 3).
5. Re-align the filter cover and turn the knob clockwise to close.
6. Your unit is equipped with one 3-in1 True HEPA filter that lasts up to 12 months depending on usage.



## Operating instructions

1. Place the unit on a dry, stable, and firm surface. Make sure not to block the top air outlet vent and air intake grille.
2. Connect the power adaptor to the power jack located on the rear base of the unit. Plug the power adaptor into the supply socket. **Note:** The display lights will initially flash on and then turn off. The power button  will remain illuminated when the unit is plugged in.
3. Tap the power button  to turn the unit ON.
4. When starting up, the appliance will operate in fan speed 3 by default.
5. To select a desired fan speed, tap the fan button  to cycle through the speeds 1 (low), 2 and 3 (high) until the desired speed setting is illuminated.
6. To set the timer for 4, 8 or 12 hours, tap the timer button  until the desired setting is illuminated. When the set time has elapsed, the appliance will automatically switch off. To deactivate the timer, tap the timer button repeatedly until the timer setting lights are turned off.
7. To turn the ioniser ON, press the  button once until the white LED light next to the button is illuminated. Press the  button again to turn the ioniser OFF.
8. To turn UV ON, press the  button once until the white LED light next to the button is illuminated. Press the  button again to turn the UV OFF.
9. To turn night mode ON, tap the  button once. The  button will illuminate and turn the display lights off. Tap the  button again to turn night mode OFF. **Note:** Night mode will maintain your previous fan speed setting.
10. To turn the night light ON, press the  button. To turn the night light OFF, press the  button once more.
11. **Important:** Always turn OFF and unplug the unit when not in use.

## Care and maintenance

- Before cleaning the air purifier, always turn OFF and unplug the unit.
- Clean the exterior surface with a clean, damp cloth.
- The top air outlet vent can be cleaned of dust with a small, soft brush.
- If you would like to clean the inside of your filter compartment, ONLY use a dry, soft cloth to wipe it down.

**WARNING:** Do not allow moisture to come into contact with the main housing of the air purifier. NEVER use detergents, glass cleaner, furniture polish, paint thinner, or other household solvents to clean any part of the appliance.

## How to replace the True HEPA filter



It is recommended to replace the 3-in-1 True HEPA filter every 12 months depending on usage.

1. The filter replacement indicator light  will illuminate red when it is time to replace the filter.
2. Turn OFF and unplug the air purifier.
3. Locate the filter cover on the bottom of the unit.
4. Rotate the knob counterclockwise to remove the cover and expose the filter (Figure 1-2 on the previous page).
5. Remove and discard the filter and re-insert a new filter (Figure 3 on the previous page).
6. Re-align the filter cover and turn the knob clockwise to close.

## HOW TO CLEAN THE FABRIC FILTER

It is recommended to clean the outer fabric filter every 3 months or when dust appears.

1. Turn the unit OFF and unplug.
2. Gently vacuum the dust from the fabric or wipe clean with a damp cloth.

7. Plug the unit and turn the power ON.
8. To reset the filter status on the air purifier, press & hold the filter replacement button  for 3 seconds. The filter icon  will turn off.

Information on where to purchase replacement filters can be found on our website at [www.sunbeam.com.au](http://www.sunbeam.com.au).  
**WARNING:** Only use the original Sunbeam filter model SAPF360D specially intended for this appliance. Do not use any other filters.

## How to Replace the UV Light Bulb

It is recommended to replace the UV light bulb every 12 months.

**CAUTION:** The UV bulb has a maximum wattage of 3.5 Watts.

**WARNING:** Always disconnect the power before replacing the UV bulb or servicing.

1. Turn the unit OFF and unplug the air purifier.
2. Locate the filter cover on the bottom of the unit.
3. Rotate the knob counterclockwise to remove the cover and expose the filter (Figure 1-2).
4. Remove the filter and set aside (Figure 3).
5. Remove the UV bulb housing by using a screwdriver to remove the four screws (Figure 4-5).

6. Carefully remove the UV bulb by rotating the bulb counterclockwise (Figure 6). Discard the old UV bulb.
7. Install the new UV bulb by rotating the bulb clockwise.
8. Re-install the UV bulb housing by using a screwdriver to secure the four screws.
9. Re-insert the filter.
10. Re-align the filter cover and turn the knob clockwise to close.

**WARNING:** Only use the original Sunbeam UV Bulb model specially intended for this appliance.

Do not use any other bulbs. Contact Sunbeam Customer Care for ordering replacement parts.

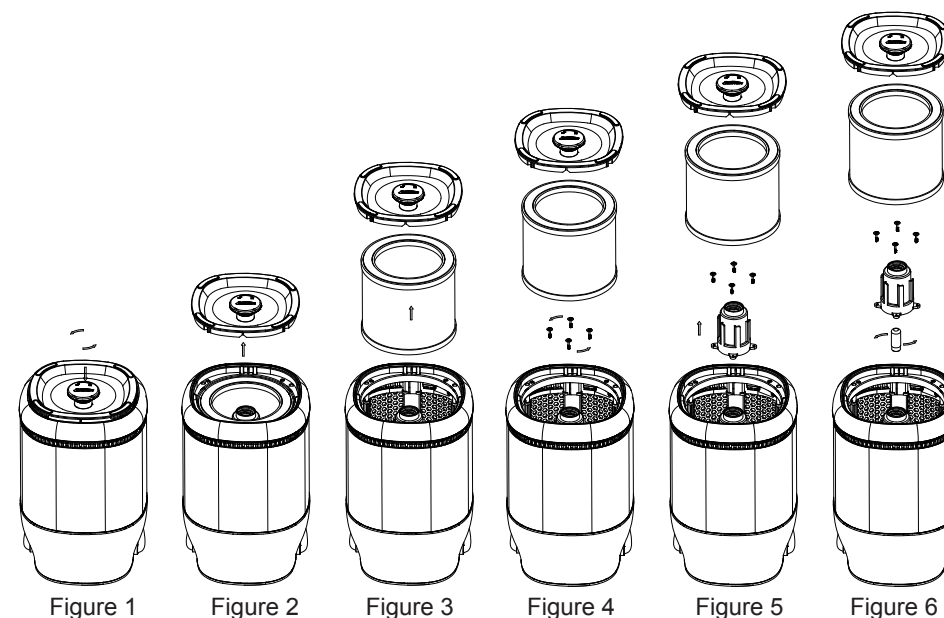



## Troubleshooting and support

For troubleshooting and FAQs visit [www.sunbeam.com.au](http://www.sunbeam.com.au).

Problem	Cause	Solution
The air purifier is not working.	The appliance is not plugged in.	Check if unit is properly plugged in and outlet is working.
	The appliance is not switched on.	Make sure unit is turned ON.
	Incorrect power adaptor used.	Use the power adaptor that is supplied with the air purifier.
	The filter is not properly installed.	Make sure filters are properly installed.
	The filter cover is not fully assembled.	Check that the filter cover is correctly assembled by re-aligning the filter cover and turn the knob clockwise to close.
The air flow has decreased.	The air intake grille and filtered air outlet may be obstructed.	Turn OFF and unplug the appliance. Remove any obstructions blocking the air intake grille, fabric pre-filter and filtered air outlet.
	The filter is nearing the end of its useful product life.	Check the condition of the filters and replace if necessary.
	Pre-installed filter is covered by a protective plastic packaging.	Check filter to remove any plastic packaging and re-install the filter.
The air purifier is making a loud noise.	Pre-installed filter is covered by a protective plastic packaging.	Check filter to remove any plastic packaging and re-install the filter.
	The ioniser may produce an occasional popping or cracking sound.	This is normal and occurs when a small buildup of ions is discharged.

**12**  
Month  
Replacement  
Guarantee

This product is covered by a 12 month replacement or repair warranty, which is in addition to your rights under the Australian Consumer Law (if your product was purchased in Australia) or New Zealand Consumer Guarantees Act (if your product was purchased in New Zealand).

Upon receipt of your claim, Sunbeam will seek to resolve your difficulties or, if the product is defective, advise you on how to obtain a replacement or refund.

To assist us in managing warranty claims, we recommend you register your product as soon as practicable after purchase, on our Sunbeam website and uploading a copy of your original receipt. View the Support section of the Sunbeam website.

In order to make a claim under our warranty, you must have the original proof of purchase documentation for the product and present it when requested (if not already uploaded to our website).

Should your product develop any defect within 12 months of purchase because of faulty materials or workmanship, we will replace or repair it, at our discretion, free of charge. A product presented for repair may be replaced by a refurbished product of the same type rather than being repaired. Refurbished parts may be used to repair the product.

Our replacement or repair warranty only applies where a defect arises as a result of faulty material or workmanship during the warranty period. Your warranty does not cover misuse or negligent handling

(including damage caused by failing to use the product in accordance with this instruction booklet), accidental damage, or normal wear and tear.

Your warranty does not:

- cover freight or any other costs incurred in making a claim, consumable items, accessories that by their nature and limited lifespan require periodic renewal (such as filters and seals) or any consequential loss or damage; or
- cover damage caused by:
  - power surges, power dips, voltage supply problems, or use of the product on incorrect voltage;

-servicing or modification of the product other than by Sunbeam or an authorised service centre;  
-use of the product with other accessories, attachments, product supplies, parts or devices that do not conform to Sunbeam specifications; or  
-exposure of the product to abnormally corrosive conditions; or

- extend beyond 3 months if the product is used in commercial, industrial, educational or rental applications.

**The benefits given to you by our warranty are in addition to other rights and remedies under law in relation to the product.**

**In Australia our goods come with guarantees that cannot be excluded under the Australian Consumer Law. You are entitled to a replacement or refund for a major failure and for compensation for any other foreseeable loss or damage. You are also entitled to have the goods repaired or replaced if the goods fail to be of acceptable quality and the failure does not amount to a major failure.**

**Our goods also come with guarantees that cannot be excluded under the New Zealand Consumer Guarantees Act.**

**If your warranty claim is not accepted, we will inform you and if requested to do so by you, repair the product provided you pay the usual charges for such repair. You will also be responsible for all freight and other costs.**

**Should your product require repair or service after the warranty period, contact your nearest service centre. For a complete list of service centres, visit our website or call our customer service line for advice on 1300 881 861 in Australia, or 0800 786 232 in New Zealand.**

**Should you experience any difficulties with your product during the warranty period, please contact our customer service line for advice on 1300 881 861 in Australia, or 0800 786 232 in New Zealand.**

### Australia

[www.sunbeam.com.au](http://www.sunbeam.com.au)  
1300 881 861

### New Zealand

[www.sunbeam.co.nz](http://www.sunbeam.co.nz)  
0800 786 232

## **Need help with your appliance?**

Contact our customer service team or visit our website for information and tips on getting the most from your appliance.

Australia | visit [www.sunbeam.com.au](http://www.sunbeam.com.au)  
phone 1300 881 861

New Zealand | visit [www.sunbeam.co.nz](http://www.sunbeam.co.nz)  
phone 0800 786 232

Newell Australia Pty Ltd. ABN 68 075 071 233

Sunbeam is a registered trade mark.

Made in China to Sunbeam's specification.

Due to minor changes in design or otherwise,

the product you buy may differ slightly from the one shown here.

Approved by the appropriate electrical regulatory authorities.

©Copyright Sunbeam 2021.

SAP1000WH\_21EM1 (ANZ)  
GCDS-SUN-JC

SAP: 2167567  
P.N: NWL0001329862