

TCL

OWNER'S MANUAL

PORTABLE AIR CONDITIONER

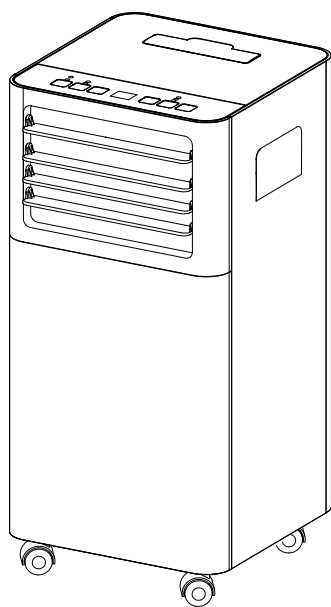

MODEL:TAC-07CPB/RV

Thank you for selecting our quality appliance.
Please be sure to read this user manual carefully before using.
For any questions, please contact the TCL Service for assistance.

IMPORTANT SAFEGUARDS

- Disconnect the appliance from its power source during service and when replacing parts and cleaning.
 - At the end of its useful life, deliver the appliance to a special waste collection center for disposal.
 - The maintenance and disposal operations must be carried out by qualified personnel only.
 - Do not use this unit for functions other than those described in this instruction manual.
 - Do not disassemble or modify the appliance or the power cord, it can result in the risk of electric shock or fire. All other services should be referred to a qualified technician.
 - Always transport your appliance in a vertical position and place on a stable, level surface during use. If the unit is transported laying on its side it should be stood up and left unplugged for 6 hours.
 - Always use the switch on the control panel or remote control to turn the unit off, and do not start or stop operation by plugging in or unplugging the power cord. It can result in the risk of electric shock.
 - Do not touch the buttons on the control panel with your wet and damp fingers.
 - Do not use hazardous chemicals to clean or come into contact with the unit. To prevent damage to the surface finish, use only a soft cloth to clean the appliance. Do not use wax, thinner, or a strong detergent.
- Do not use the unit in the presence of inflammable substance or vapor such as alcohol, insecticides, gasoline, etc.
- If the appliance is making unusual sounds or is emitting smoke or an unusual odor, unplug it immediately.
 - Do not clean the unit with water. Water can enter the unit and damage the insulation, creating a shock hazard. If water enters the unit, unplug it immediately and contact Customer Service.
 - Utilize two or more people to lift and install the unit.
 - Always grasp the plug when plugging in or unplugging the appliance. Never unplug by pulling on the cord. It can result in the risk of electrical shock and damage.
 - Install the appliance on a sturdy, level floor capable of supporting up to 110lbs(50kg). Installation on a weak or unlevel floor can result in the risk of property damage and personal injury.
 - This appliance is not intended for use by persons (including children) with reduced physical, sensory or mental capabilities, or lack of experience and knowledge, unless they have been given supervision or instruction concerning use of the appliance by a person responsible for their safety.
 - Children should be supervised to ensure that they do not play with the appliance.
 - If the supply cord is damaged, it must be replaced by the manufacturer, its service agent or similarly qualified persons in order to avoid a hazard.
 - The appliance shall be installed in accordance with national wiring regulations.

IMPORTANT SAFEGUARDS

Specific information regarding appliances with R290 refrigerant gas





- **WARNING:** Thoroughly read all of the warnings.
- **WARNING:** When defrosting and cleaning the appliance, do not use any tools other than those recommended by the manufacturing company.
- **WARNING:** The appliance shall be stored in a room without continuously operating ignition sources (eg: open flames, an operating gas appliance or operating electric heater). The area of the storage room should be no less than 13 m²
- **WARNING:** This appliance must be installed and used in an area greater than 13 m².
- **WARNING:** Do not pierce or burn the refrigeration circuit.
- **WARNING:** Keep ventilation openings clear of obstruction.
- **WARNING:** The appliance shall be stored so as to prevent mechanical damage from occurring.
- **WARNING:** Servicing shall only be performed as recommended by the equipment manufacturer.
- **WARNING:** Be aware that refrigerants may not contain odour.



caution, risk of fire



Explanation of symbols displayed on the portable air conditioner.

| | | |
|---|----------------|--|
|  caution, risk of fire | WARNING | This symbol shows that this appliance uses a flammable refrigerant. If the refrigerant is leaked and exposed to an external ignition source, there is a risk of fire. |
|  | CAUTION | This symbol shows that the operation manual should be read carefully. |
|  | CAUTION | This symbol shows that a service personnel should be handling this equipment with reference to the installation manual. |
|  | CAUTION | This symbol shows that information is available such as the operating manual or installation manual. |

DESCRIPTION

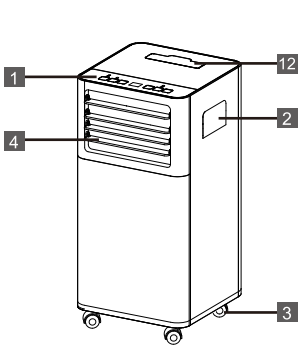

1. Control panel
2. Handle (both side)
3. Castors
4. Deflector
5. Intake grille
6. Air outlet grille
7. Intake grille
8. Power cable
9. Plug fixer
10. Middle condenser drain
11. Condenser drain
12. Remote control slot

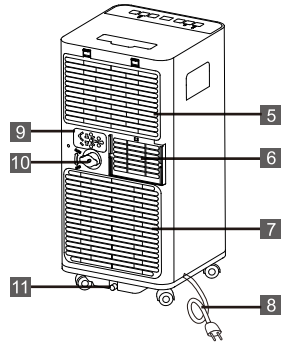

ACCESSORIES

| PARTS | PARTS NAME | QUANTITY |
|-------|---|----------|
| | Exhaust hose Hose outlet Hose inlet | 1 set |
| | Window slider kit | 1 set |
| | Remote Control Batteries (2 * AAA 1.5V) | 1 set |

Note: All the illustrations in this manual are for explanatory purposes only. Your appliance may be slightly different. Be sure all accessories are removed from the packing before use.

INSTALLATION INSTRUCTIONS

EXHAUSTING HOT AIR

In the Cool Mode the appliance must be placed close to a window or opening so that the warm exhaust air can be ducked outside.

First position unit on a flat floor and make sure there's a minimum of 17.7" (45cm) clearance around the unit, and is within the vicinity of a single circuit outlet power source.

1. Extend either side of the hose (Fig.1)
2. Screw the hose inlet (Fig.2).
3. Screw it to the hose inlet (Fig.3).
4. Install the hose inlet into the unit (Fig.4).
5. Affix the hose outlet into the window slider kit and seal. (Fig.5 &6).

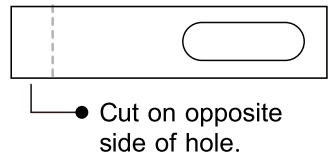
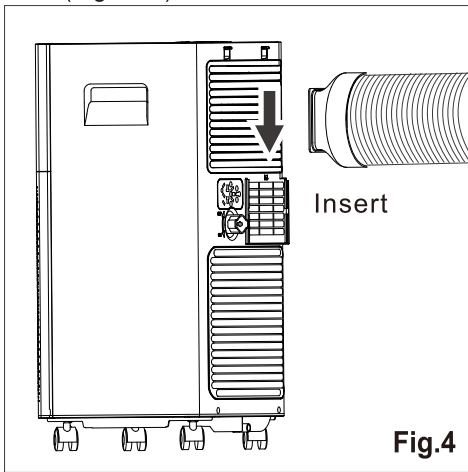
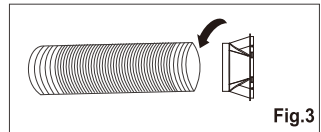
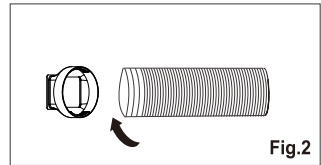
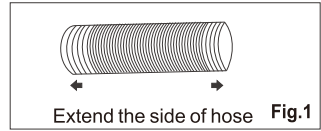

The window slider kit has been designed to fit most standard vertical and horizontal window applications; however, it may be necessary for you to modify some aspects of the installation procedures for certain types of windows. The window slider kit can be fastened with screws.

NOTE: If the window opening is less than the minimum length of the window slider kit, cut the end without the hold in it short enough to fit in the window opening. Never cut out the hole in window slider kit.

INSTALLATION INSTRUCTIONS

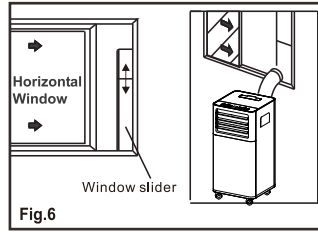
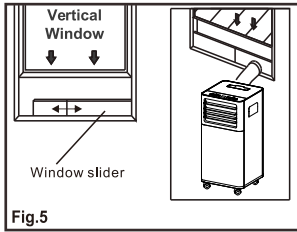

WINDOW SLIDER KIT INSTALLATION

1: Parts:

A) Panel

B) Panel with one hole

C) Screw to lock window kit in place

2: Assembly:

Slide Panel B into Panel A and size to window width.

Windows sizes vary. When sizing the window width, be sure that the window kit assembly is free from gaps from gaps and/or air pockets when taking measurements.

3. Lock the screw into the holes that correspond with the width that your window requires to ensure that there are no gaps or air pockets in the window kit assembly after installation.

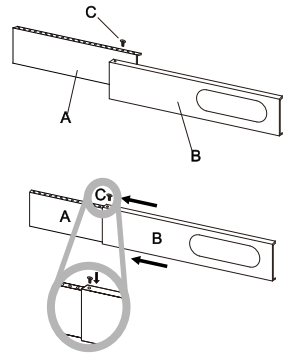

LOCATION

- The unit should be placed on a firm foundation to minimize noise and vibration. For safe and secure positioning, place the unit on a smooth, level floor strong enough to support the unit.
- The unit has casters to aid placement, but it should only be rolled on smooth, flat surfaces. Use caution when rolling on carpeted surfaces. Use caution and protect floors when rolling over wood floors. Do not attempt to roll the unit over objects.
- The unit must be placed within reach of a properly rated grounded socket.
- Never place any obstacles around the air inlet or outlet of the unit.
- Allow at least 45cm of around and above space away from the wall for efficient working.
- The hose can be extended, but it is the best to keep the length to minimum required. Also make sure that the hose does not have any sharp bends or sags.

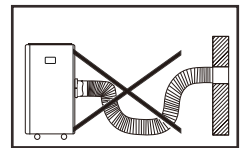
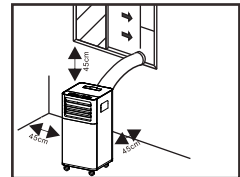

DESCRIPTION OF THE DISPLAY SCREEN

The control panel is on the top of the appliance, enables you to manage part functions without remote controller.

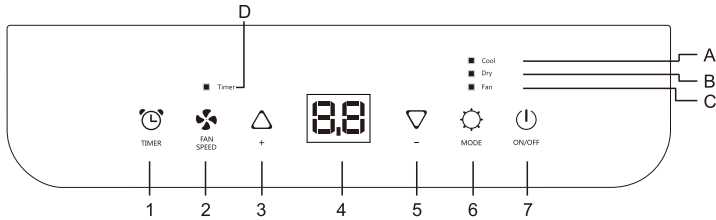

- 1. Timer button
 - 2. Fan button
 - 3. Increase button
 - 4. Display screen
 - 5. Decrease button
 - 6. Mode button
 - 7. ON/OFF button
- A. Cool symbol
 - B. Dehumidify symbol
 - C. Fan symbol
 - D. Timer symbol

TURNING THE APPLIANCE ON

Plug into the mains socket, then the appliance is standby.

Press the (⏻) button to make the appliance turn on. The last function active when it was turned off will appear.







√ Never turn the air conditioner off by unplugging from the mains. Always press the button (⏻), then wait for a few minutes before unplugging. This allows the appliance to perform a cycle of checks to verify operation.

DESCRIPTION OF THE DISPLAY SCREEN

COOL mode

Ideal for hot muggy weather when you need to cooling and dehumidify the room.

To set this mode correctly:

- Press the “” button a number of times until the “Cool” symbol light appears.
- Select the target temperature 18°C-32°C (64°F-90°F) by pressing the “” or “” button until the corresponding value is displayed.
- Select the required fan speed by pressing the “” button.

Different fan speed have different function.

High speed display “F2”, low speed display “F1”.





| | |
|---------|--|
| F2 High | To achieved the temperature as fast as possible. |
| F1 Low | Run of the low noise. |

The most suitable temperature for the room during the summer varies from 24°C to 27°C. You are recommended, however, not to set a temperature much below the outdoor temperature. This will cause unnecessary power consumption.

FAN mode

When using the appliance in this mode, the air hose does not need to be attached.

To set this mode correctly:

- Press the “” button a number of times until the “Fan” symbol appears.
- Select the required fan speed by pressing the “” button.

Two speeds are available: High/Low



High





Low

DESCRIPTION OF THE DISPLAY SCREEN

DRY mode

Ideal to reduce room humidity (spring and autumn, damp rooms rainy periods, etc.). Before using the dry mode, the appliance should be prepared in the same way as for cool mode, with the air exhaust hose attached to enable the moisture to be discharged outside.

To set this mode correctly:



- Press the “” button a number of times until the “Dry” symbol light appears, the screen will appear “” ;
- In this mode, fan speed is selected automatically by the appliance.





SETTING THE TIMER

This timer can be used to delay the appliance start up or shut down, this avoids wasting electricity by optimizing operating periods.

Programming start up

- Turn on the appliance, choose the mode you desire, for example cooling, 24°C and high fan speed. Turn off the appliance.
- Press the  button, the screen will display 1-24 hours.
- Press several times until the corresponding time is displayed. Wait about 5 seconds, the timer will be active, then “Timer” symbol is displayed on screen.
- Press again the “” button, the timer will be canceled, and the “Timer” symbol will disappear from screen.

Programming shut down

- Under the running of appliance, please press the  button, the screen will display 1-24 hours.
- Press several times until the corresponding time is displayed. Wait about 5 seconds, the timer will be active, then “Timer” symbol is displayed on screen.
- Press again the “” button, the timer will be canceled, and the “Timer” symbol will disappear from screen.

DESCRIPTION OF THE DISPLAY SCREEN

Switch the unit of temperature

When the appliance is running, hold on “ \triangle ” and “ ∇ ” button together 3 seconds by the same time, then you can change the unit of temperature.

For example:

Before change, in cool mode, the screen display like fig1.

After change, in cool mode, the screen display like fig2.





Fig.1



Fig. 2

SELF-DIAGNOSIS

The appliance has a self-diagnosis system to identify a number of malfunctions. Error messages are displayed on the appliance display.

| IF IS DISPLAYED | WHAT SHOULD I DO? |
|--|---|
|  PROBE FAILURE (sensor damaged) | If this is displayed, contact your local authorize service center. |
|  FULL TANK (safety tank full) | Empty the internal safety tank, following the instructions in the "End of season operations" paragraph. |

REMOTE CONTROL MANUAL

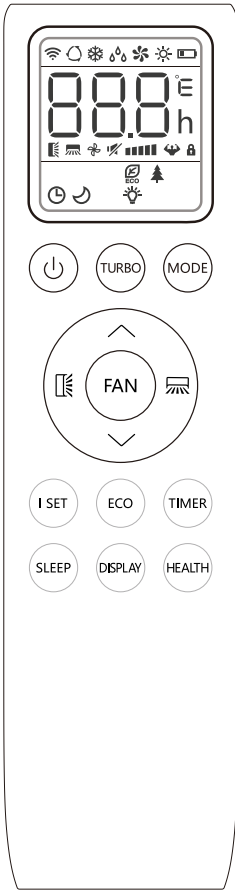

Remote controller buttons

















| | |
|---------------|---|
| | To turn on/off the air conditioner. |
| MODE | To select the operation mode: SMART, COOL, DRY, FAN, HEAT. |
| (TEMP UP) | To increase the setting temperature, lengthen the time in TIMER setting. |
| (TEMP DN) | To decrease the setting temperature, reduce the time in TIMER setting. |
| | To adjust the air flow direction vertically (No available for this model). |
| | To adjust the air flow direction horizontally. |
| FAN | To adjust the fan speed: auto, low, mid, high. |
| TURBO | To switch on/off the TURBO mode. |
| I SET | To activate the function of I SET (No available for this model). |
| ECO | To switch on/off the ECO mode (No available for this model). |
| TIMER | To switch on/off the TIMER function. |
| SLEEP | To switch on/off the SLEEP mode. |
| DISPLAY | To switch on/off the LED display light (No available for this model). |
| HEALTH | To switch on/off the HEALTH function (No available for this model). |
| (^ + v) | To activate the function of Child Lock, press ^ and v buttons together for more than 3 seconds. |

- ⚠ The display and some functions of the remote control may vary according to the model.
- ⚠ The shape and position of buttons and indicators may vary according to the model, but their function is the same.
- ⚠ The unit confirms the correct reception of each button with a beep.
- ⚠ There might some functions not fit for your air conditioner, you will hear a beep when you press these buttons, but air conditioner does not response, we express our apologies.

REMOTE CONTROL MANUAL

Remote controller DISPLAY, meaning of symbols on the liquid crystal display



| | |
|---|--|
|  | SMART MODE indicator |
|  | COOLING MODE indicator |
|  | DRY MODE indicator |
|  | FAN MODE indicator |
|  | HEATING MODE indicator |
|  | BATTERY indicator |
|  | FLAP SWING (Air flow) indicator |
|  | TEMPERATURE/ CLOCK indicator |
|  | FAN SPEED indicator |
|  | AUTO FAN indicator |
|  | TIMER indicator |
|  | SLEEP MODE indicator |
|  | TURBO indicator |
|  | MUTE indicator (No available for this model). |
|  | ECO indicator (No available for this model). |
|  | HEALTHY indicator (No available for this model). |
|  | DISPLAY LIGHT indicator (No available for this model). |

REMOTE CONTROL MANUAL

- ✓ Point the remote control at the receiver on the appliance.
- ✓ The remote control must be no more than 7 meters away from the appliance (without obstacles between the remote control and the receiver).
- ✓ The remote control must be handled with extreme care.

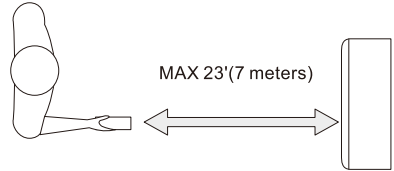

Do not drop it or expose it to direct sunlight or sources of heat.

If the remote control does not work, please try to take out the battery, and put it back.

Replacement of Batteries

Remove the battery cover plate from the rear of the remote controller, by sliding it in the direction of the arrow.

Install the batteries according the direction (+and -) shown on the Remote Controller. Reinstall the battery cover by sliding it into place.

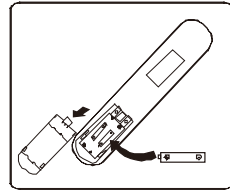

- ⚠ Use 2 LR 03 AAA(1.5V) batteries. Do not use rechargeable batteries. Replace the old batteries with new ones of the same type when the display is no longer legible.
- Do not dispose batteries as unsorted municipal waste. Collection of such waste separately for special treatment is necessary.

NOTE:

- ✓ If the remote-control unit is replaced or disposed of, the batteries must be removed and discarded in accordance with current legislation as they are harmful to the environment.
- ✓ Do not mix old and new batteries. Do not mix alkaline, standard (carbon-zinc) or rechargeable (nickel-cadmium) batteries.
- ✓ Do not dispose of batteries in fire. Batteries may explode or leak.
- ✓ If the remote control is not be used for a certain length of time, remove the batteries.

REMOTE CONTROL MANUAL

TURN ON / TURN OFF THE AIR CONDITIONER

Press the button  to turn on or turn off the air conditioner.

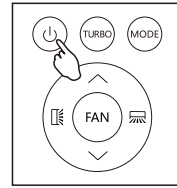

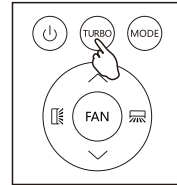

SWITCH THE UNIT OF TEMPERATURE

Press the TURBO button hold it, then you can change the unit of temperature.



COOLING MODE

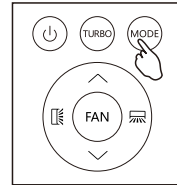

The cooling function allows the air conditioner to cool the room and at the same time reduces Air humidity.

- To activate the cooling function (COOL) ,press the MODE button until the symbol  appears on the display.
- With the button  or  set a temperature 18°C-32°C (64°F-90°F)lower than that of the room.



HEATING MODE

The heating function allows the air conditioner to heat the room.

- To activate the heating function (HEAT) , press the MODE button until the symbol  appears on the display.
- With the button  or  set a temperature 13°C-27°C (55°F-81°F) higher that of the room.

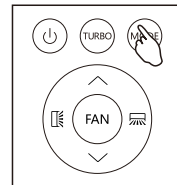

REMOTE CONTROL MANUAL

NOTE: In HEATING operation, the appliance can automatically activate a defrost cycle, which is essential to clean the frost on the condenser so as to recover its heat exchange function. This procedure usually lasts for 2-10 minutes. During defrosting, the unit fan stop operation. After defrosting, it resumes to HEATING mode automatically.

- In this mode, you may have to wait for a few minutes before the appliance starts giving out hot air.
- In this mode, the fan may operate for short periods, even though the set temperature has already been reached.
- Water is removed from the air and collected in the tank.
- When the tank is full, the appliance shuts down and “**FL**” (full tank) appears on the display. The tank cap must be extracted and emptied. Run off all water left into a basin. When all the water has been drained, put the cap back in place.
- When the tank has been emptied, the appliance starts up again.

DRY MODE

This function reduces the humidity of the air to make the room more comfortable.

- To set the DRY mode, Press MODE until  appears in the display.

An automatic function of pre-setting is activated.

- In this mode, fan speed is selected automatically by the appliance and cannot be set manually.

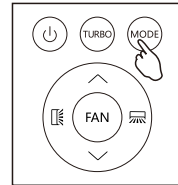

In dry mode, the appliance should be prepared in the same way as for cool mode, with the air exhaust hose attached to enable the moisture to be discharged outside.

FAN MODE(Not FAN button)

Fan mode, air ventilation only.

- To set the FAN mode, press MODE until  appears on the display.

When using the appliance in this mode, the air hose does not need to be attached.

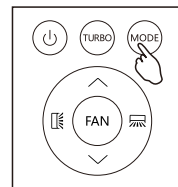

REMOTE CONTROL MANUAL

SMART MODE

•To set the SMART mode, press MODE until  appears on the display.

In SMART mode the run mode will be set automatically according to the room temperature.

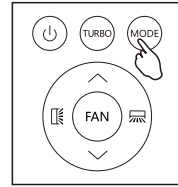

If the appliance is cooling only model , the unit operates in Fan mode when the room temperature is below 23°C (73°F) , and Cool mode when the room temperature is above 23°C(73°F).

If the unit is cooling and heating model , the unit operates in Heatmode when the room temperature is below 20°C(68°F) , and Fan mode when the room temperature is from 20°C (68°F) to 23°C(73°F) , and Cool mode when the room temperature is above 23°C (73°F).

Display on the control panel:

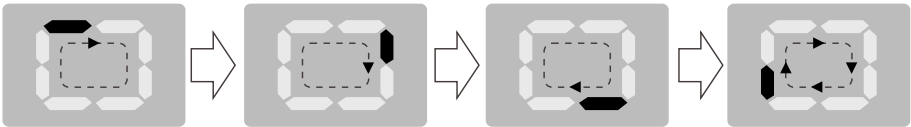



It is SMART mode when the display will be running circulating.

Change the fan speed

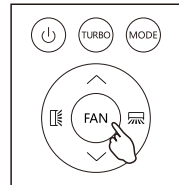
•Press FAN button to set the running fan speed, it can be set to : LOW/HIGH/AUTO speed.





Flashing:

| Low | | High | |
|---|---|---|--|
|  |  |  |  (FLASH) |

REMOTE CONTROL MANUAL

AIR FLOW CONTROL

- To set this function correctly:
Select the operating mode (cool, dry, fan, heat) as described above.
Press the  button, the deflector will start or stop swing.
The  button function is optional.

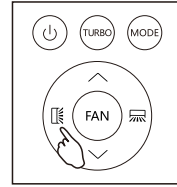

NOTE: Never poke fingers, sticks or other objects in the air inlet or outlet vents. Such accidental contact with live parts might cause unforeseeable damage or injury.

SLEEP MODE

Pre-setting automatic operating program.
This function is useful for the night as it gradually reduces operation of the appliance.

- To set this function correctly:
Select the cool or heat mode as described above.
Press SLEEP button to activate the sleep mode, and  appears on the display.

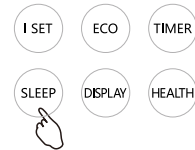

The SLEEP function can be canceled at any time during operation by pressing the "SLEEP", "MODE" or "FAN" button.

In FAN or DRY mode, SLEEP function is still available.

When you choose the sleep function, the screen will reduce the brightness, and the fan speed is low.

The SLEEP function maintains the room at optimum temperature without Excessive fluctuations in either temperature or humidity with silent operation.

Fan speed is always at Low, while room temperature and humidity vary gradually to ensure the most comfortable.

When in COOL mode, the selected temperature will increase by 1°C(1°F) per hour in a 2-hour period. This new temperature will be maintained for the next 6 hours.

Then the appliance turns it off.

When in HEAT mode, the selected temperature will decrease by 1°C(1°F) per hour in a 3 hour period. This new temperature will be maintained for the next 5 hours. Then the appliance turn it off.

REMOTE CONTROL MANUAL

TIMER MODE----SET TIMER OFF

To set the switching-off automatically air conditioner
With the AC on, press the TIMER button and then use the \vee and \wedge buttons to set the length of time before the AC will turn off.
Press the timer button again to start the countdown.

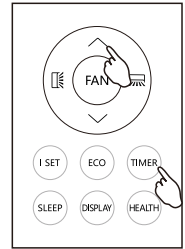

Note:To cancel the setted function, press the TIMER button again.
Note:In case of power off,it is necessary to set TIMER OFF again.



TIMER MODE----SET TIMER ON

To set the switching-on automatically air conditioner
With the AC off, press the TIMER button and use the \vee and \wedge buttons to set the desired amount of time before the AC turns on.
Press the timer button again to start the countdown.

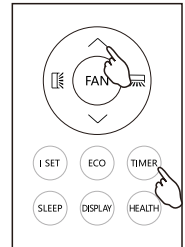

Note:To cancel the set function, press the TIMER button again.
Note:In case of power off,it is necessary to set TIMER ON again.



REMOTE CONTROL MANUAL

Turbo function (Optional)

To activate turbo function, press the TURBO button, and  will appear on the display. In COOL mode, when you select TURBO feature, the appliance will operate the fast cooling with the highest fan speed.

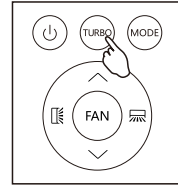

ECO MODE (Optional) (No available for this model)

In this mode the appliance automatically sets the operation to save energy.

Press the ECO button, the  appears on the display, and the appliance will run in ECO mode. Press again to cancel it.

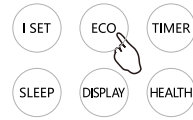

NOTE: The ECO function is available in both COOLING and HEATING modes.

LED display light ON/OFF (Optional) (Not available for this model)

Press DISPLAY button and hold for 2s to turn on/off the unit LED display light.

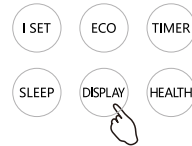

HEALTH function (Optional) (Not available for this model)

Press HEALTH button to active / exit the health functions such as ion generator/ plasma etc



Note:

Health function is not available when the air conditioner is off.

TIPS FOR CORRECT USE

TIPS FOR CORRECT USE

To get the best from your appliance, follow these recommendations:

- Close the windows and doors in the room to be air conditioned (Fig. 21). When installing the appliance semi-permanently, you should leave a door slightly open (as little as 1 cm) to guarantee correct ventilation;
- Protect the room from direct exposure to the sun by partially closing curtains and/or blinds to make the appliance much more economical to run (Fig. 22);
- Never rest objects of any kind on the appliance;
- Do not block the air inlet or outlet of the appliance. Reduced air flow will result in poor performance and could damage the unit (Fig. 23).
- Make sure there are no heat sources in the room;
- Never use the appliance in very damp rooms (laundries for example).
- Never use the appliance outdoors.
- Make sure the appliance is standing on a level surface. if necessary, place the castor locks under the front wheels.

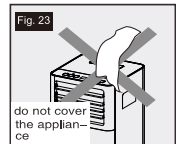
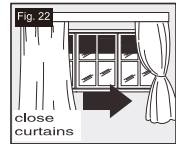
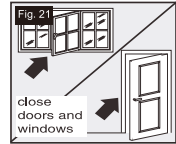

WATER DRAINAGE METHOD

When there is excess water condensation inside the unit, the appliance stops running and shows “F L” (FULL TANK as mentioned in SELF-DIAGNOSE). This indicates that the water condensation needs to be drained using the following procedures:

Manual Draining (Fig.24)

1. Unplug the unit from power source.
2. Place a pan(not supply) under the lower drain plug. See diagram.
3. Remove the lower drain plug.
4. Water will drain out and collect in the pan.
5. After the water is drained, replace the lower drain plug firmly.
6. Turn on the unit.

Continuous Draining (Fig.25)

1. Unplug the unit from the power source.
2. Remove the drain plug. While doing this operation some residual water may spill so please have a pan (not supply) to collect the water.
3. Connect the drain hose (1/2" or 12.7mm, maybe not supplied). See diagram.
4. The water can be continuously drained through the hose into a floor drain or bucket.
5. Turn on the unit.

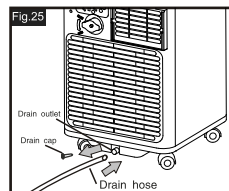
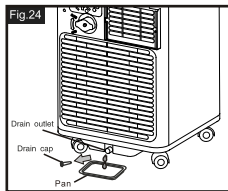

NOTE:

Please be sure that the height of and section of the drain hose should not be higher than that of the drain outlet, or the water tank may not be drained.(Fig.26 and Fig.27)

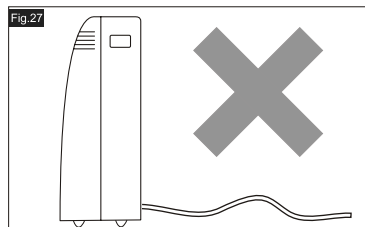
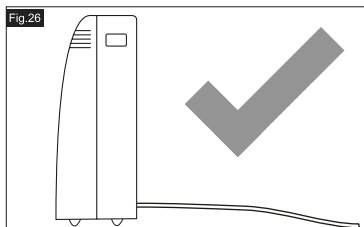

WATER DRAINAGE METHOD

Middle drainage

When unit running in Dry mode, you can choose the way below to drainage.

1. Unplug the unit from the power source.
2. Remove the drain plug(Fig.A). While doing this operation some residual water may spill so please have a pan to collect the water.
3. Connect the drain hose (1/2" or 12.7mm, maybe not supplied). (Fig.B)
4. The water can be continuously drained through the hose into a floor drain or bucket.
5. Turn on the unit.

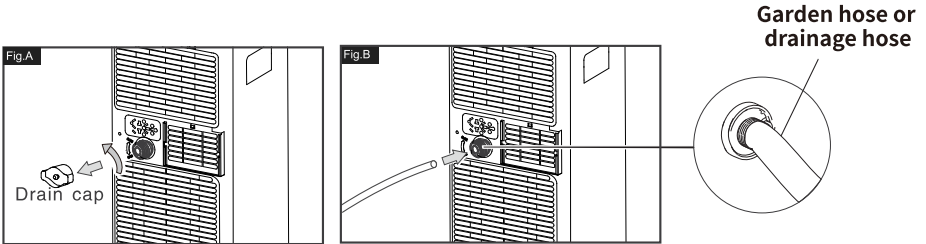

NOTE:

Please be sure that the height of and section of the drain hose should not be higher than that of the drain outlet, or the water tank may not be drained. Please see following fig.

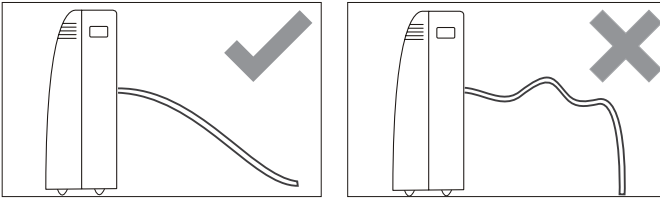

CLEANING

Before cleaning or maintenance, turn the appliance off by pressing the  button on the control panel or remote control, wait for a few minutes then unplug from the mains socket.

CLEANING THE CABINET

You should clean the appliance with a slightly damp cloth then dry with a dry cloth, may not used water to wash appliance.

- Never wash the appliance with water. It could be dangerous.
- Never use petrol, alcohol or solvents to clean the appliance.
- Never spray insecticide liquids or similar.

CLEANING THE AIR FILTERS

To keep your appliance working efficiently, you should clean the filter every week of operation.

Follow the **Fig.28** direction and open the grid of appliance, then take out evaporator from the back of grid.

To avoid possible cuts, avoid contacting the metal parts of the appliance when removing or re-installing the filter. It can result in the risk of personal injury.

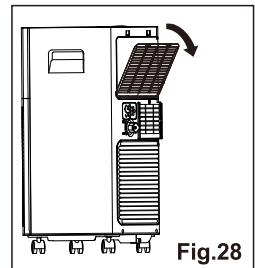

Fig.28

Use a vacuum cleaner to remove dust accumulations from the filter. If it is very dirty, immerse in warm water and rinse a number of times. The water should never be hotter than 40°C(104°F). After washing, leave the filter to dry then attach the intake grille to the appliance.

START-END OF SEASON OPERATIONS

START OF SEASON CHECKS

Make sure the power cable and plug are undamaged and the earth system is efficient. Follow the installation instructions precisely.

END OF SEASON OPERATIONS

To empty the internal circuit completely of water,remove the cap. Run off all water left into a basin. When all the water has been drained, put the cap back in place.

Clean the filter and dry thoroughly before putting back.

Strictest operation environment:

Cooling mode: 18°C-35°C (64°F-95°F) , 30%RH~90%RH

Heating mode: 10°C-25°C (50°F-77°F) , 30%RH~90%RH

TROUBLESHOOTING

| PROBLEM | CAUSE | SOLUTION |
|--|---|--|
| The appliance does not come on | <ul style="list-style-type: none"> • There is no current • It is not plugged into the mains • The internal safety device has tripped | <ul style="list-style-type: none"> • Wait • Plug into the mains • Wait 30 minutes, if the problem persists, contact your service center |
| The appliance works for a short time only | <ul style="list-style-type: none"> • Here are bends in the air exhaust hose • Something is preventing the air from being discharged | <ul style="list-style-type: none"> • Position the air exhaust hose correctly, keeping it as short and free of curves as possible to avoid bottlenecks • Check and remove any obstacles obstructing air discharge |
| The appliance works, but does not cool the room | <ul style="list-style-type: none"> • Windows, doors and/or curtains open | <ul style="list-style-type: none"> • Close doors, windows and curtains, bearing in mind the "tips for correct use" given above |
| | <ul style="list-style-type: none"> • There are heat sources in the room (oven, hairdryer, etc) | <ul style="list-style-type: none"> • Eliminate the heat sources |
| | <ul style="list-style-type: none"> • The air exhaust hose is detached from the appliance | <ul style="list-style-type: none"> • Fit the air exhaust hose in the housing at the back of the appliance |
| | <ul style="list-style-type: none"> • The technical specification of the appliance is not adequate for the room in which it is located | |
| During operation, there is an unpleasant smell in the room | <ul style="list-style-type: none"> • Air filter clogged | <ul style="list-style-type: none"> • Clean the filter as described above |
| The appliance does not operate for about three minutes after restarting it | <ul style="list-style-type: none"> • The internal compressor safety device prevents the appliance from being restarted until three minutes have elapsed since it was last turned off | <ul style="list-style-type: none"> • Wait. This delay is part of normal operation |
| The following message appears on the display: PF / FL | <ul style="list-style-type: none"> • The appliance has a self diagnosis system to identify a number of malfunctions | <ul style="list-style-type: none"> • See the SELF-DIAGNOSIS Chapter |

TECHNICAL SPECIFICATIONS

| | |
|----------------------------------|-----------------------------------|
| MODEL NO: | TAC-07CPB/RV |
| Voltage/Frequency | 220-240V~/50Hz |
| Cooling Capacity | 7,000BTU/h(2050W) |
| Cooling Input Power | 785W |
| Cooling Current | 3. 5A |
| Rated Power | 950W |
| Rated Current | 3. 9A |
| Air Flow | 260m³/h |
| Refrigerant/ Charge/GWP | R290/0.16kg/3 |
| Co2 equivalent | 0.0005tonnes |
| Ingress Protection Rating | IPX0 |
| Timer | 1-24 Hr |
| Fan Speed | Low/High |
| Operation Mode | Cool/Dry/Fan |
| Dimensions | 320mm(W)x320mm(D)x670mm(H) |
| Weight | 22kg |



Like us on Facebook

TCL Electronics Australia Pty Ltd.

ABN 83 111 032 896

Telephone: 1300 738 149

service.au@tcl.com

www.tcl.com/au