



The Creative Life

- Before using your washing machine, please read this manual carefully and keep it for future reference.
- This manual is also available online.
- The drawings in this manual are for instructional purpose only, they may vary from the model you have purchased

WASHING MACHINE OWNER'S MANUAL

Model: P608FLW / P609FLW



Contents

Products Specification.....	1
Safety Precaution.....	2
Important Hints.....	4
Overview of the Washing Machine.....	5
Washing Machine Installation	6
Washing Machine Operation.....	9
Maintenance.....	14
Troubleshooting.....	16
Appendix.....	18

Products Specification

Parameter / Capacity	7.5kg	8.5kg
Model	P608FLW	P609FLW
Voltage	220-240V~/50Hz	
Rated Power	1900W	1950W
Permissible Water Pressure	0.05-0.8MPa	
Outer Dimension (W*D*H)mm	595*560*850	595*625*850

▲NOTE:

**All the pictures in the manual are used as reference only.
It may be different from the machine you buy.**

Safety Precaution

⚠ WARNING

To reduce the risk of fire, electric shock, or injury to persons when using your appliance, follow basic precautions, including the following

- If the power cord is damaged, it must be replaced by the manufacturer, service agent or similarly qualified persons in order to avoid the hazard.
- The new hose-sets supplied with the washer are to be used and that old hose-sets should not be reused.
- This appliance is not intended for use by persons (including children) with reduced physical, sensory or mental capabilities, or lack of experience and knowledge, unless they have been given supervision or instruction concerning use of the appliance by a person responsible for their safety. Children should be supervised to ensure that they do not play with the appliance.
- This appliance can be used by children aged from 8 years and above and persons with reduced physical, sensory or mental capabilities or lack of experience and knowledge if they have been given supervision or instruction concerning use of the appliance in a safe way and understand the hazards involved. Children shall not play with the appliance. Cleaning and user maintenance shall not be made by children without supervision.
- The washing machine must not be placed on carpet as it may block the ventilation opening on the base.
- Children of less than 3 years should be kept away unless continuously supervised.
- This appliance is intended to be used in household and similar applications such as:
 - staff kitchen areas in shops, offices and other working environments;
 - farm houses
 - by clients in hotels, motels and other residential type environments;
 - bed and breakfast type environments;
 - areas for communal use in blocks of flats or laundrettes.
- Take care that power voltage and frequency shall be identical to those of washing machine.
- To ensure your safety, power cord plug must be inserted into an earthed socket. Check carefully and make sure that your socket is proper and earthed reliably.
- Do not use any socket with rated current less than that of washing machine.
- Do not operate your washer when parts are missed or broken.
- Never pull out power plug with wet hands.

Safety Precaution

- If the supply cord is damaged it must be replaced by the manufacturer, it's service agent or similarly qualified persons in order to avoid a hazard.
- Unplug your washer before cleaning or making any repair.
- Please check whether the water inside the drum has been drained before opening the door. Please do not open the door if there is any water visible.
- Glass door may be very hot during the operation. Keep kids and pets far away from the washer during the operation.
- Make sure that the water and electrical device are connected by a qualified technician in accordance with the manufacturer's instruction and local safety regulations.
- Before operating this machine, all packages and transit bolts must be removed. Otherwise, the washing machine may be seriously damaged while washing the clothes.
- Flammable and explosive or toxic solvents are forbidden. Gasoline and alcohol etc. shall not be used as detergents. Please only select the detergents suitable for machine washing.
- Be careful of scalding while the washer is draining hot washing water.
- Never unplug your washer by pulling on the supply cord. Always grasp the plug firmly and pull straight out from the outlet.
- Packing materials may be dangerous to the kids. Please keep all packing materials (plastic bags, foams etc) far away from the kids.
- Do not climb up and sit on top cover of the machine.
- Pets and kids may climb into the machine. Check the machine before every operation.
- Do not lean against the door of the washer.

Important Hints

- The household washing machine isn't intended to be built-in.
- This washing machine is for indoor using only.
- Make sure that all pockets are empty. Sharp and rigid items such as coins, brooches, nails, screws or stones etc. May cause serious damage to the washer.
- Please remember to disconnect water and power supply immediately after the clothes are washed.
- The washing machine shall not be installed in bath rooms or very wet areas, as well as in the rooms with explosive or caustic gases.
- Before washing clothes for the first time, the washing machine shall be operated with a full cycle without clothes inside.
- Repair or replacement of any part of the washer are to only be carried out by the manufacturer or authorised TCL service centre.
- It is forbidden to wash carpets and bras inset with steel wire. It is recommended bras with steel wire are placed in a laundry bag.
- Never refill water by hand during washing.
- After the program is completed, please wait for two minutes to open the door.
- When handing the machine, the accumulated water shall be drained out of the machine first. Handle the machine carefully. Never hold each protruded part on the machine while lifting. The machine door can not be used as the handle during transportation.
- Washing machines with single inlet valve only can be connected to the cold water supply. Washing machines with double inlet valves can be connected to the hot water and cold water supply.

Overview of the Washing Machine

SAVE THESE INSTRUCTIONS THIS MACHINE IS FOR HOUSEHOLD USE ONLY

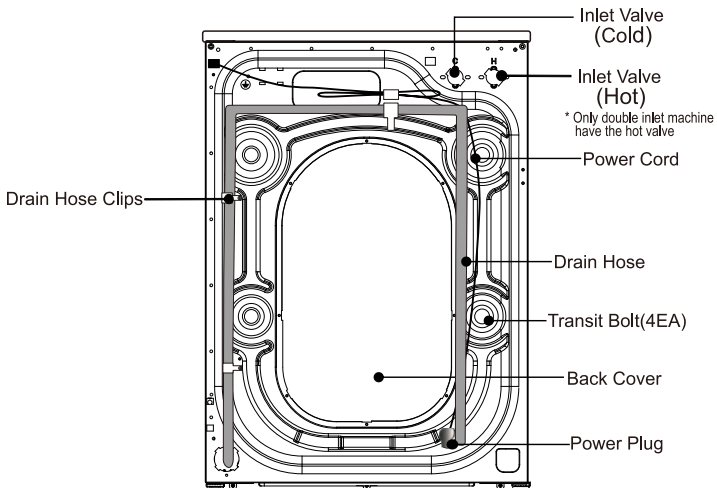
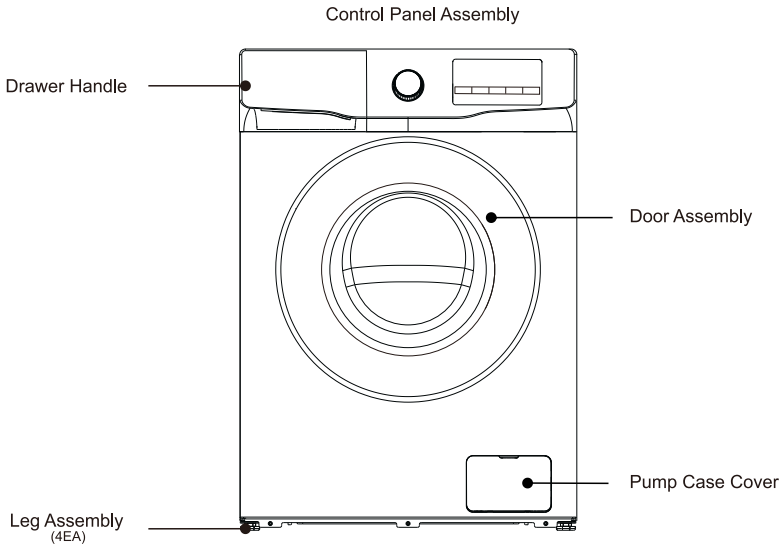

Washing Machine Installation

NOTE

We recommend that your new washer is installed by a qualified appliance technician. If you feel that you have the skills to install the washer, please read the installation instructions carefully before installing.

■ Tools needed





You may need to have the following tools to help you in the installation of your washer:

- Scissors
- Gloves
- Standard Screwdriver
- Pliers
- Spanner

■ Unpacking the washing machine

Unpacking your washing machine and check if is there any damage during the transportation. Also make sure that all the items (as shown below) in the attached bag are received. If there is any damage to the washing machine during the transportation, or any item is missing or damaged, please contact your place of purchase immediately.

If your washing machine is not double inlet, you will not have the hot inlet hose.

Inlet Hose (Connect to cold water supply)	Hot Inlet Hose* (Connect to Hot water supply)	Hole Cover (4EA) (Used to plug transit bolt holes)	Drain Hose Support Bracket (Used to loop the end of drain hose)	Spanner (1. Used to adjust the bottom of the machine, 2. Remove the transport bolt on the back of the machine)
				

*If your washing machine is not double inlet, the machine does not have the hot inlet hose.

■ Select the location

Before installing the washer, a location characterized as follows shall be selected:

- Rigid, dry, and level surface (if not level, please make it level with reference to the following figure 'Adjustable Leg').
- Avoid direct sunlight.
- Sufficient ventilation.
- The ambient temperature shall be between 0-40°C.
- The ambient humidity shall be below 95% (When the temperature is 25°C).
- Keep far away from heat sources such as coal or gas. Make sure that the washer will not stand on the power cord. Do not install the washer on carpet floors.

Washing Machine Installation

■ Remove transit bolts

Before using this washing machine, transit bolts must be removed from the backside of this machine. Please take the following steps to remove the bolts:

⚠ Keep the transit bolts properly for further use.

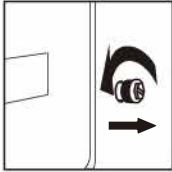

1. Loosen the four transit bolts with a spanner

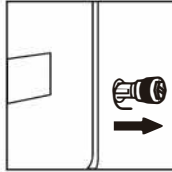

2. Take each bolt head and pull it through the wide part of the hole. Repeat for each bolt.

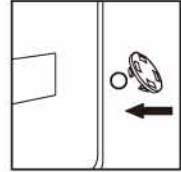

3. Fill the holes with the supplied plastic covers.

■ Level the washing machine

Install or place the washing machine under the environmental temperature of no less than 0°C. Do not install outdoors, for it may damage the programming controller.

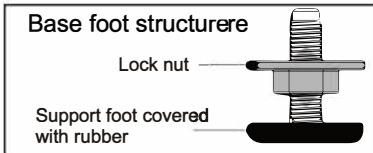

Base foot structure

Lock nut

Support foot covered with rubber

Factory status

- Locking nut close to bottom of box
- Supporting foot close to locking nut

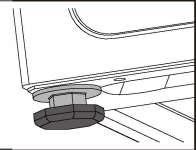

⚠ Note: in order to facilitate installation, the factory status of the foot may not be all locked, please be sure to lock all four feet before adjusting the level!

1. When placing the machine, check whether the bottom foot is in the factory state. If not, please restore the bottom foot to the factory state: the locking nut is locked tightly on bottom of the box, and the support foot is locked tightly on the locking nut:

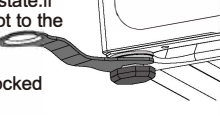

2. After the machine is placed, press the opposite corner of the top cover plate of the washing machine with both hands in turn and shake it vertically downward to check whether the supporting foot is close to the ground and whether the machine is moving

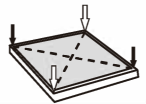

3. To ensure that the machine is placed in the right state, loosen the locking nut according to the direction shown in the diagram with the attached spanner to the appropriate height until the supporting foot is close to the ground and the machine is free from movement.



Support base is close to the ground

4. Finally, use the spanner to turn the lock nut back to the bottom of the box to lock it (you can also slightly fix the support foot by hand to avoid the support foot moving again)

Ensure that the supporting feet do not move again



⚠ CAUTION

1. The machine must be perfectly leveled and stabilized when the four supporting feet are close to the ground. Lower the feet as much as possible on the basis that the machine is leveled.
2. Improper leveling adjustment may cause loud noise, machine vibrating, machine displacement and other abnormal phenomena.
3. The Air-vent is designed on the bottom of the machine (prevent blockage). Install the washing machine on solid, smooth and skid-proof ground. Do not place the washing machine on a soft blanket or wooden floor, or various desktops and stands, to prevent unnecessary injury.

Washing Machine Installation

■ Connect the inlet hose

1. Connect the inlet hose to the tap and fasten it anticlockwise.

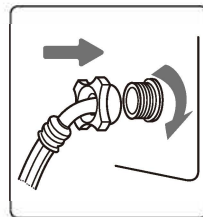
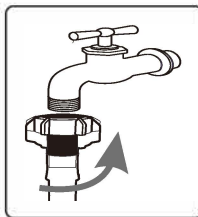

2. Connect the other end of the inlet hose to the inlet valve at the rear of the washing machine and fasten the hose tightly clockwise. When there is one inlet at the back of the machine, it must be connected to a cold water supply. If there are two inlet valves, one is connected to a cold water supply and the other is connected to a hot water supply. Follow the indication of the picture below to complete the connection.

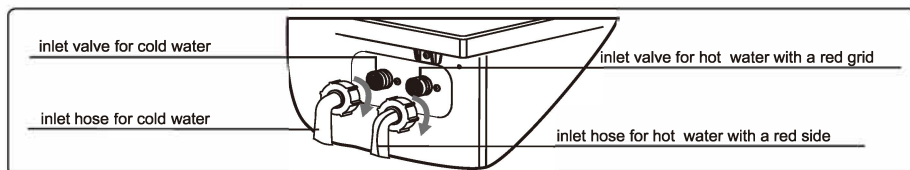

⚠ NOTE

- If there is any leakage with the hose after the connection, repeat the steps to connect inlet hose.
- Do not bend the hose.
- Check the inlet hose connection carefully before using the washer each time.

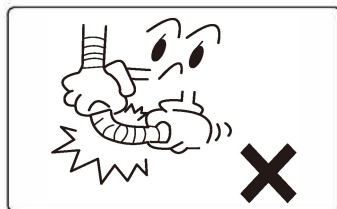

■ Connect the drain hose

- The drain hose shall be placed at a height of 65-100cm above the floor, otherwise, it can cause poor drainage
- You can use the supplied drain hose support bracket to loop the drain hose down into the wall, standpipe or laundry tub.
- Take care to ensure all hose connections are tight.

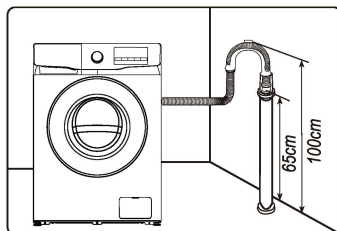
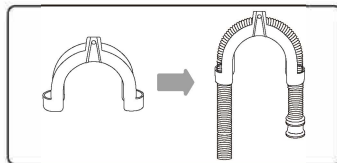

⚠ NOTE

- The end of the drain hose cannot be immersed in water for the washer to work properly.

Washing Machine Installation

■ Connect the power

- As the maximum current through the unit is 1 0A when you are using its heating function, please make sure the power supply system (current, power voltage and wiring) in your home can meet the normal loading requirements of the electrical appliance.
- Please connect the power to a socket which is correctly installed and properly earthed.
- Make sure the power voltage at your power outlet is same to that in the machine's rated voltage.
- Power plug must match the socket.
- Do not use a multi-purpose plug or socket as extension cord.
- Do not connect and pull out plug with wet hands.
- When pulling out the plug, hold the plug tightly and then pull it out. Do not pull the power cord forcibly.
- Any electrical components (plug, power cord etc.) must be replaced by a certified agent or qualified service personnel.

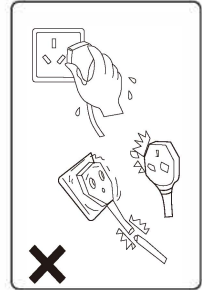

WARNING

- 1.This machine must be earthed properly. If there is any short circuit, earthing can reduce the danger of electrical shock.
2. The washing machine shall be operated in a circuit separate from other electrical appliances. Otherwise, power protector may be tripped or fuse may be burned out.

Washing Machine Operation

NOTE

Ensure your machine is installed properly before use.

Before washing clothes for the first time, you must run a complete cycle without clothes. To do this:

- 1.Connect power source and water.
- 2.Put a little detergent(about 10g) into the drawer and close it.
- 3.Press the On/Off button.
- 4.Turn the knob to the "Cotton" .
- 5.Press the Start/Pause button.

This will remove any water from the manufacturer's test run remaining in the machine.

Washing Machine Operation

Sort clothes

Please read this recommendation carefully to avoid any washing machine issues and damage to clothes.

1. Do not put clothes over the rated load capacity.
2. Sort the laundry by colour and by care label. Most garments have a textile care label in the collar or side seam.
3. Make sure all the pockets are empty, Foreign objects (e.g. nails, coins, paper clips, etc.) can cause damage to garments and components in the machine.
4. Close any zips, fastening hooks etc. before washing.
5. For clothes to be washed, they should be sorted according to color. Dark coloured clothes should not be washed with light coloured clothes.
6. Badly soiled areas, stains etc. should be pre-treated with liquid detergent, stain removers etc.
7. Turn over clothes which pill easily, or clothes with woolen surfaces before putting them into the machine.

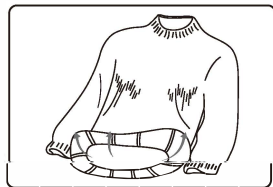
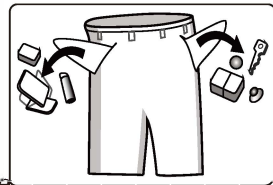

NOTE: Make sure that no clothes are caught between the door and the seal.

Add detergent

1. Pull out the detergent drawer.
2. Add detergent for prewash into compartment I
3. Add detergent for main wash into compartment II
4. Add fabric softener into compartment.
5. Please choose a suitable type of detergent for the various washing temperature to get the best washing effect with less water and energy consumption.

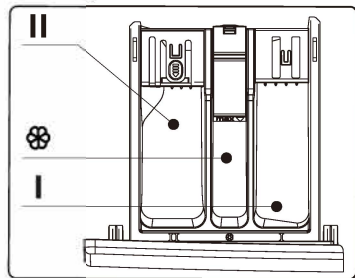

View of control panel

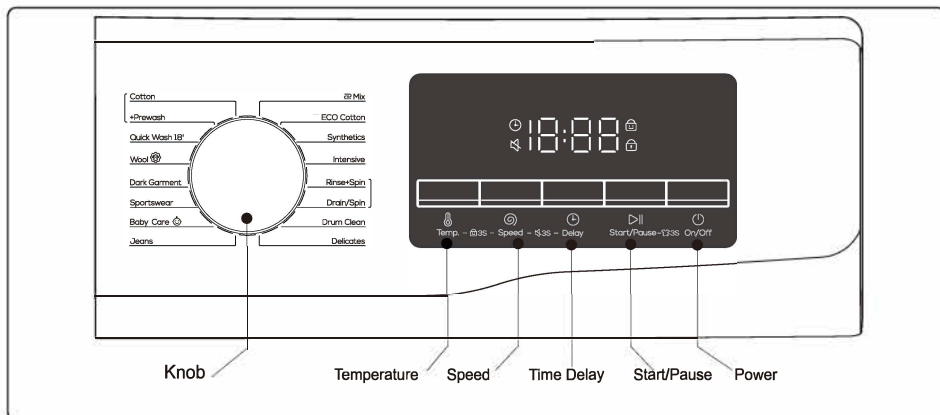





Washing Machine Operation

■ Function

- **Temperature Button:** Use this button to select water temperature. Available selections (from cold to max °C) vary for each cycle. The targeted setting will blink on the screen during the selection process.
- **Speed Button:** Use the button to select a spin speed. Available selections (from 0 to max rpm) vary for each cycle. The targeted setting will blink on the screen during the selection process.
- **Time Delay Button:** Press the button repeatedly to cycle through the available delayed start options (from 3 to 24 hours in one hour increments).
- **Start/Pause Button:** Press the button once to start a cycle. Press the button a second time will pause the operating cycle. During a pause, setting and options can be modified and selected again if it is permitted. Pressing the button again will resume the active cycle.
- **Power Button:** Press once to turn the washing machine on, press again to turn the washing machine off. If the washing machine power is left on for longer than 10 minutes without any buttons being touched, the power automatically turns off.

■ Indicators

-  : When the indicator appears, it means the "Time Delay" function has been selected.
-  : Press the "Speed" and "Delay" button simultaneously for 3 seconds after the wash cycle has started to activate or deactivate the "Sound Off" function.
-  : Press the "Temp" and "Speed" button simultaneously for 3 seconds after the wash cycle has started to activate or deactivate the "Child Lock" function.
-  : The indicator will appear on when the door is locked.

■ Programme

Cotton: It is recommended for washing hard-wearing fabrics, heat-resistant fabrics made of cotton or linen.

+Prewash: The Prewash function can get an extra wash before a main wash. When you choose this cycle, detergent for prewash is recommended to be put into the detergent drawer ("compartment I", as shown in page 10) .

Quick Wash 18': This cycle is suitable for washing a small amount of lightly soiled clothes quickly.

Washing Machine Operation

Wool : You can select this cycle to wash wool textiles labeled with "Machine Wash". Please select the proper washing temperature according to the label on the articles to be washed.

Dark Garment: You can select this cycle to wash dark-coloured fabrics made of cotton and dark easy-care fabrics.

Sportswear: The cycle is quite suitable for sports clothes.

Baby Care : This cycle has an increased rinse time to ensure laundry detergent is well removed to reduce skin allergy.

Jeans: The cycle is suitable for jeans or fabrics made of denim.

 **Mix:** You can select this cycle to wash clothes that are different kinds, except for colours. Dark clothes should not be washed with clothes that are of light colours.

ECO Cotton: Energy saving mode.
Energy saving and environmental protection.

Synthetics: You can select this cycle to wash delicate clothes. It is recommended to wash fabrics made of silk, satin, synthetic fibers or blend.

Intensive: You can select this cycle wash tough clothes, that need much more strength.

Rinse+Spin: This cycle is used to clean remaining detergent in clothes and extract water from clothes.



Drain/Spin: This cycle is use to extract water from clothes.

Drum Clean: This cycle is specially set in this machine to clean the drum and tube. It applies 60/90°C high temperature sterilization to make the drum and tube more clean. When a proper amount bleach is used, the barrel cleaning effect will be better. When you run this program, we suggest not to put in any clothes, you can use this procedure regularly according to the need.



Delicates: This cycle is suitable for delicate garments made of synthetic fibres, mixed fibres, rayon and easy care cottons. Also suitable for machine-washable silks.

Washing Machine Operation

■ Features

- 1.Power-off memory:** In case of power failure during the cycle, the settings will be saved, and operation will resume when the power is restored.
- 2.Child lock:** Press the “Temp.” and “Speed” button simultaneously for 3 seconds to activate or cancel the “Child lock”feature to avoid mis-operations. When the feature is activated,the indicator ‘’lights up, all buttons cannot be set until the operation is canceled.
- 3.Sound off:** Press the “Speed” and “Delay” button simultaneously for 3 seconds can activate or cancel the “Sound off” feature. When the feature is activated, the indicator ‘’ lights up, the sound of knob operation and all the button actions will disappear.
- 4.Unbalance protection:** When the machine is ready to spin, The washer may take some time to balance clothes due to unbalancing. If the clothes are still unbalance in the drum after that, the spinning speed can be slow down to avoid vibration. If there are not enough clothes in the drum, the machine may not to spin due to the unbalance protection feature, then you should add more clothes in the machine to make it to spin.
- 5.Reload:**If you want to add clothes in the washer during the cycle, press the “Start/Pause” button for 3s,when you hear two beeps, it means the reload feature has been activated. Please wait for the indicator ‘’ to disappear, then open the door. Press the “Start/Pause” button to resume the cycle after reload.

■ Table of Washing Procedures

Parameter Procedure	Max Load(kg)		Temp. Range (°C;- = cold)	Speed Range (r/min;0=no spin)
	7.5kg	8.5kg		
Cotton	7.5	8.5	--~Max	0~Max
+Prewash	5.5	6	--~Max	0~Max
Quick Wash 18'	3	3.5	--~30	0~1000
Wool 	3	3.5	--~40	0~600
Dark Garment	4.5	5	--~40	0~1000
Sportswear	3.5	4	--~40	0~800
Baby Care 	4.5	5	--~60	0~Max
Jeans	4.5	5	--~40	0~Max
 Mix	4.5	5	--~40	0~1000
ECO Cotton	4.5	5	--~40	0~1200/Max
Synthetics	4.5	5	--~60	0~800
Intensive	7.5	8.5	--~60	0~Max
Rinse+Spin	7.5	8.5	--	0~Max
Drain/Spin	7.5	8.5	--	0~Max
Drum Clean	0	0	60/Max	800
Delicates	4.5	5	20	0~800

Maintenance

Proper maintenance on the washing machine can extend its work life.



Before your maintenance starts, please pull out the power plug or disconnect power and close the tap.

■ Clean internal drum

The rust left inside the drum by the metal articles shall be removed immediately with chlorine-free detergents. Never use steel wool.

■ Clean surface

- 1.If there is any water overflow, use a dry cloth to wipe it off immediately. No sharp items are allowed to strike the washer.
- 2.The surface can be cleaned with a diluted non-abrasive neutral detergent when necessary.

■ Clean the drain pump

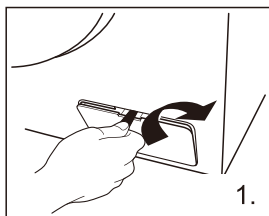

Open the filter cover with tools such as coins according to the direction of the graphic;

Unscrew the filter and pay attention to the remaining water, taking out any foreign material from the drain pump filter;

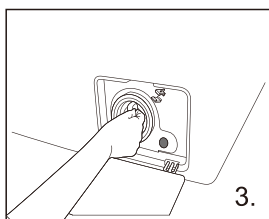
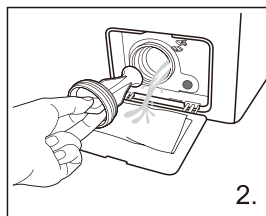

Reinstall the filter.

Maintenance

■ Clean Inlet valve filter

The inlet filter shall be cleaned if there is not any or insufficient water when the tap is opened.

1. Lower the water pressure:
 - a. Close the tap.
 - b. Select any procedure except “Spin” procedure.
 - c. Press the button “Start/Pause” and keep the procedure running for about 40 seconds.
 - d. Pull out the power plug.
2. Remove the inlet hose from the tap.
3. Use water to wash the filter.
4. Reconnect the inlet hose.

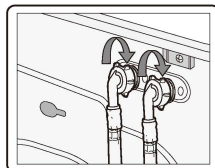
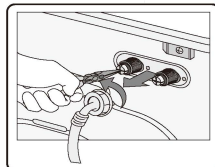

■ Clean detergent drawer

1. Press down the part ① inside the drawer and take out the detergent drawer.
2. Lift the clip up and take out softener cover and wash all grooves with water.
3. Restore the softener cover and push the drawer into position.

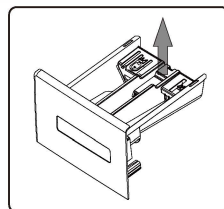
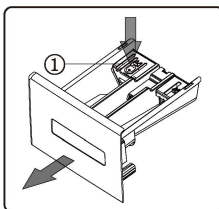

Troubleshooting

TROUBLES

SOLUTIONS

There is some remaining water in the machine



This is normal and is the result of water tests performed at the factory

The washer does not run



Check if the power plug is inserted well.
Check if the tap is opened.
Check if the button "Power" is pressed.
Check if the button "Start/Pause" is pressed. Check if the delay feature is activated.

Water leakage



Check and fasten inlet hose.
Clean up drain hose and ask a specialized person to repair it when necessary.

Abnormal noise and severe vibration



Check if the transit bolts has been removed.
Check if the adjustable legs are adjusted level.
Check if the washer is installed on the solid and level floor.
Check if there are any barrettes or metal articles inside.

Washing efficiency is not satisfactory



Select a proper procedure.
Add the proper detergent quantity according to the instructions in detergent package.

The machines buttons will not respond to presses



Check if the "Child-lock" feature has been activated.
Press the "Start/Pause" button first then press other buttons.

Actual running time of the cycle does not corresponded to the display time



Check if clothes in the drum is dispersed well.
Check if the water is drained out, and water is inflowing well.

The washer fills while draining



Check if the max height of the drain hose is lower than 65cm
Check if the drain hose is immersed.

Troubleshooting

























DISPLAY	MEANS	SOLUTIONS
E 1	The washer fill time is too slow	Check if the tap is opened. Check if the water pressure is too low. Check if the inlet hose is blocked.
E 2	Water drainage is too slow	Check if the drain pump is blocked. Contact a technician if necessary.
E 3	Door lock issue	Close the door well again. Check if the clothes is caught between the door and seal. Contact a technician if necessary.
E 4	Water is overflowed	Let the machine drain out water automatically until the water level is suitable for wash procedure. Contact a technician if necessary.
E 5	The electrical motor issue	Please contact a technician.
E 6	Heater issue	Please contact a technician.
E 7	Temperature Sensor fault	Please contact a technician.
E 9	communication failure	Please contact a technician.
E 10	Inverter failure	Please contact a technician.
EP	The procedure running is not corresponded to the cycle that the knob points.	Turn the cycle selector to the cycle corresponded to the procedure working on.

▲ NOTE

Please refer to the actual purchased model for fault displays. Different models have different fault displays

Appendix

■ Fabric Care Label

	Resistant material		Can be ironed at 100°C max
	Delicate fabric		Do not iron
	Item may be washed at 90°C		Can be dry cleaned using any solvent
	Item may be washed at 60°C		Dry clean with perchloride, lighter fuel, pure alcohol or R113 only
	Item may be washed at 40°C		Dry clean with aviation fuel, pure alcohol or R113 only
	Item may be washed at 30°C		Do not dry clean
	Item may be hand washed		Dry flat
	Dry clean only		Can be hung to dry
	Can be bleached in cold water		Dry on clothes hanger
	Do not bleach		Tumble dry, normal heat
	Can be ironed at 200°C max		Tumble dry, reduced heat
	Can be ironed at 150°C max		Do not tumble dry

■ Electrical Warning

To avoid fire, electrical shock and other accidents, please remember the following reminding:

- Only the voltage indicated in power label can be used. If you are not clear of the voltage at home, please contact the local power bureau.
- When you are using the heating function, the maximum current through the washing machine will reach 10A. Therefore, please make sure the power supply units(current, voltage and cable) can meet the normal load requirements for the machine.
- Protect the power cord properly. Power cord shall be fixed well so that it will not be a trip hazard and risk other items being damaged. Special attention shall be paid to the plug location.
- Do not make the wall-mounted socket overloaded or cable extended. Over loading of the wiring may cause fire or electrical shock. Do not pull out power plug with wet hands.
- To ensure your safety, the power plug shall be inserted into an earthed socket. Carefully check and ensure that your socket is properly and reliably earthed.

Appendix

■ Protecting the environment

- The washer is manufactured by recyclable materials. If you decide to dispose of this washer, please observe the local waste disposal regulations. Cut off the power cord so that the washer cannot be connected to power. Remove the door so that small animals and children cannot get trapped inside the washer.
- Do not exceed the detergent quantities recommended in the detergent manufactures' instruction.
- Use stain removal products and bleaches before the wash cycle only when strictly necessary.
- Save water and electricity by only washing full loads (the exact amount depends upon the program used).

▲NOTE:

Standard programme for the Energy and Water Labelling according to AS/NZS2040.1 : 2005:

P608FLW

* ECO Cotton, 40°C, 1400rpm, is the default setting and the recommended wash programme for normally soiled 7.5kg cotton load.

** The detergent dosage: rated capacity* 12.5g*80% and anti-foam aid is 15g.

*** Detergent dissolvent method: Dissolve the detergent first and pour the dissolved detergent into the machine when the main wash starts.

P609FLW

* ECO Cotton, 40°C, 1200rpm, is the default setting and the recommended wash programme for normally soiled 8.5kg cotton load.

** The detergent dosage: rated capacity* 12.5g*80% and anti-foam aid is 17g.

*** Detergent dissolvent method: Dissolve the detergent first and pour the dissolved detergent into the machine when the main wash starts.



The Creative Life

TCL Electronics Australia Pty Ltd.
ABN 83 111 032 896
Telephone: 1300 738 149
sales.au@tcl.com
www.tcl.com/au