



HYDROTAP G5 BC CUBE BRUSHED GOLD



BOILING

CHILLED

FILTERED

Order Code H53784Z07AU

Zip HydroTap Design Range Boiling, Chilled, Filtered water system features a single under bench command centre including full colour interactive touch screen display with pin code protection and customisable settings including boiling water safety mode, 3 energy saving modes including ON/OFF timers and 2 hour sleep mode, 'Quiet' mode with automated intelligent fan speed adjustment, SteriTouch® antimicrobial protection impregnated into key water paths for enhanced hygiene, 100% water efficient air cooled technology, and 0.2 micron water filtration.

Manufacturing Code	H53784Z07AU
--------------------	-------------

Capacity	Residential
----------	-------------



Tap	Zip HydroTap Design Range CUBE Tap (Brushed Gold)
Water Pressure	Min 170kPa - Max 700kPa
Water Connection	1/2" BSP (G1/2)
Water Supply Requirements	Cold
Water Valves	Integrated 500kPa Pressure limiting valve and Dual Check Valve
Power Rating	1.44kW 220-240V 50Hz
Power Supply	1 x 10 Amp socket outlet
Dimensions	W280mm x D455mm x H333mm
Product Approvals	WaterMark, RCM, ARC
Warranty	5 years (appliance warranty 36 months plus additional 24 months tank warranty)

Installation Requirements

'1. Installation and connection of your Zip HydroTap must be carried out by a qualified person, observing national and local regulations.2. You will require suitable mains electrical and drinking water connections, plus waste water drainage all within 1.5 metres of the product.3. HydroTap is air-cooled so discrete cabinetry cut-outs are required for ventilation.4. Installation on most bench tops is straightforward however some stone bench tops may require a specialised cutting service.5. If you live in a hard water area, we recommend installation of a Zip scale filtration kit.6. Installation by Zip Professional Service can be arranged with a phone call or through www.zipwater.com'

Installation Detail



Ventilation requirements Contact your local service provider if ventilation is not suitable

Clearance envelope

Position the Tap and the Command Centre as close together as possible.

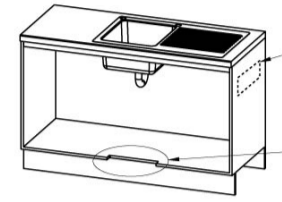
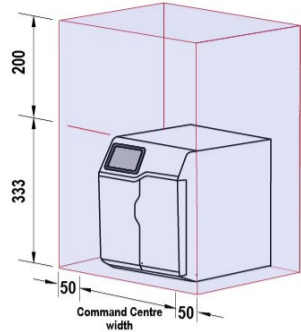

Air outlet louvre (if required)
Cut-out in door/wall, towards the top of the cabinet

Air inlet cut-out (required)
Cut-out in cabinet floor

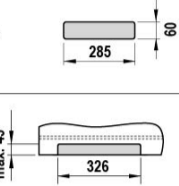

HydroTap Tap options

HydroTap Arc Tap

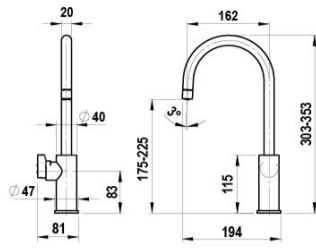

Standalone Font with Arc Tap

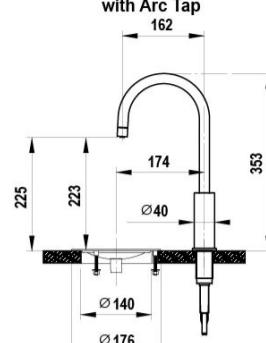

HydroTap Cube Tap

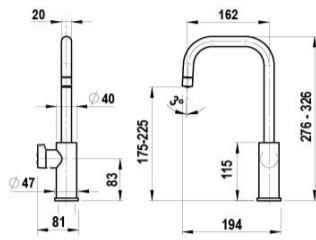

Cutting detail

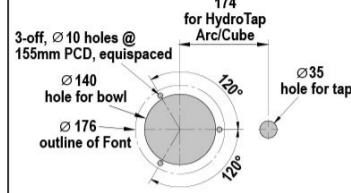

Tap Positioning

Position the Tap to dispense into the sink, allowing clearance for a cup or teapot. Alternatively, mount on a Font (available as an accessory).

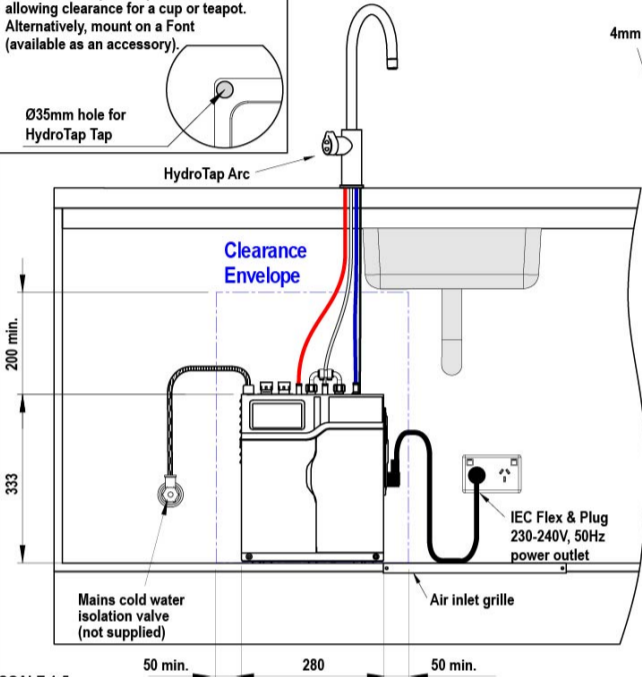

4mm buffer pad air space

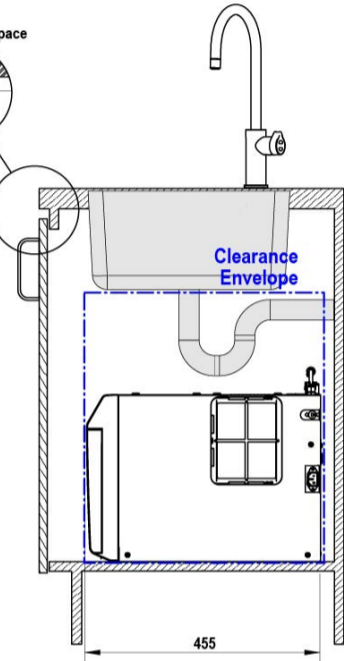

SCALE 1:5
ALL DIMENSIONS IN MM UNLESS OTHERWISE SPECIFIED. INSTALLATION DIAGRAMS ARE FOR ILLUSTRATIVE PURPOSES ONLY. HOSES ARE NOT SHOWN TO SCALE AND CANNOT BE LENGTHENED.

**HydroTap G5
BC Home, BC20**
shown with HydroTap Arc

