



HydroTap G5[®]



Australia



UK

Visit our website to download the manuals

Table of contents

SECTION 1: SAFETY	5
1.1 Explanation of symbols	5
1.2 Before you start	5
SECTION 2: Using the HydroTap.....	6
2.1 Classic Plus, Elite Plus	7
2.2 Touch-Free Wave	8
2.3 Arc / Arc Plus, Cube / Cube Plus and Celsius.....	10
2.4 Classic	11
2.5 HydroTap Mixer taps.....	12
SECTION 3: Command Centre Screen.....	13
3.1 How to use the Command Centre screen	13
3.2 Home screen	15
3.3 Main menu	16
3.4 General settings	16
3.5 System settings	18
3.5.1 Filter settings.....	19
3.5.2 Temperature settings	22
3.5.3 CO ₂ settings	24
3.5.4 Dispense times	26
3.5.5 Light sensor	26
3.5.6 Quiet mode	27
3.5.7 Advanced settings 1	27
3.5.8 Advanced settings 2 (Wave Tap only)	28
3.5.9 System restart.....	28
3.6 Safety & security	29
3.6.1 Boiling safety.....	29
3.6.2 Passcode protect	30
3.7 Energy saving	31
3.7.1 Sleep mode	31
3.7.2 On/Off Timer.....	32
3.7.3 Energy Use.....	33
3.8 Info & logs	34
SECTION 4: User maintenance.....	35
4.1 Changing the internal filter	35
4.2 Air inlet filter maintenance	37
4.3 Cleaning	38
4.4 CO ₂ cylinder and regulator	39
4.4.1 Changing the 2.64kg CO ₂ cylinder	41
4.4.2 Changing the 1.2kg CO ₂ cylinder	42

Register product

- Navigate to the register product menu.
- Scan the QR code and follow the on screen steps to register your product.

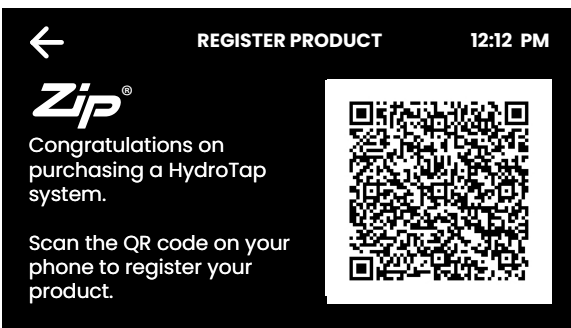
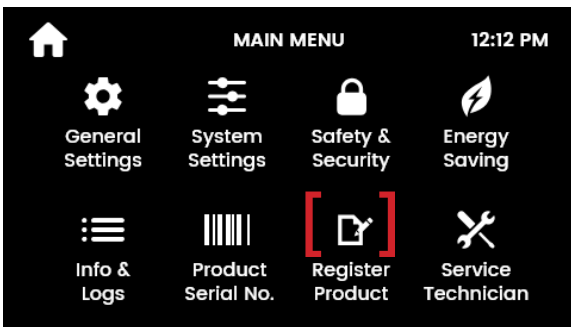

**The screens referenced in this manual are current as per firmware v0.4.12F.

SECTION 1: SAFETY

1.1 Explanation of symbols



Read the instructions



WARNING



Danger of electric shock



Hot surface

1.2 Before you start



Read the WARNINGS and PRECAUTIONS.

Download & read the complete Command Centre installation instruction manual and user guide.



Read and use the instructions supplied with individual kit components for safe use and installation of replacement consumables.

SECTION 2: Using the HydroTap

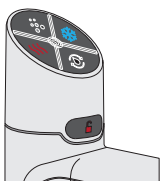

Classic Plus, Elite Plus

See page 6

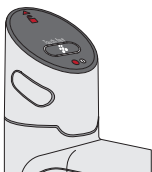

Touch-Free Wave

See page 7

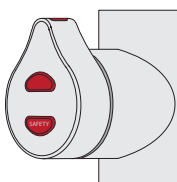

Arc / Arc Plus, Cube / Cube Plus and Celsius

See page 9



Classic

See page 10

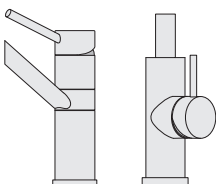

HydroTap Mixer Taps

See page 11

SECTION 2: Using the HydroTap

2.1 Classic Plus, Elite Plus

Controls Press to dispense

Simply press to dispense
chosen water type

Safety lock

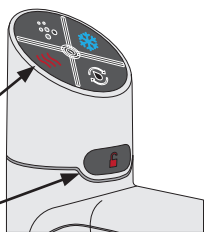

Lights



FLASHING

Change filter or CO₂.



ON Safety lock on.

OFF Safety lock off.

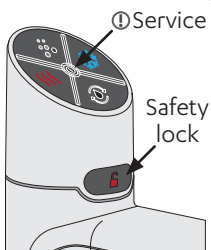

ON

Ready to dispense.

FLASHING SLOWLY

Water temperature not at set point.

FLASHING QUICKLY

System fault.



ON

Bottle fill
enabled

FLASHING

Activated,
(press water
choice)

Dispense options



Press the icons to dispense water choice.



+



Boiling



Chilled



Sparkling



Bottle fill
(then
press water
choice)

SECTION 2: Using the HydroTap

2.2 Touch-Free Wave

Controls Touch-free sensors on the tap top, back and sides.

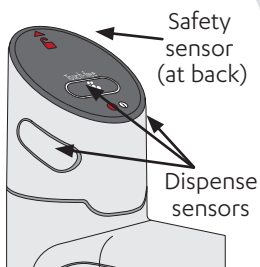

Clearance requirements

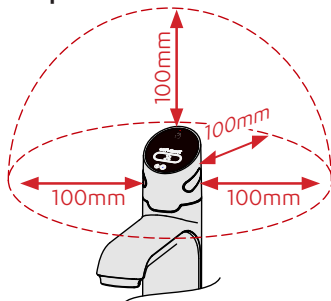

Lights



RED Boiling & safety sensors activated, water dispensed.

BLUE Chilled sensor activated, water dispensed.

WHITE Sparkling sensor activated, water dispensed.

PURPLE Lock mode on (when tap is idle).

Flashing RED Sensor activated incorrectly; hand may be too close to sensor, sensor has been touched or covered.

WHITE / BLUE / RED Cycling 5 to 10 seconds Filter needs replacing, CO₂ warning (G5), unit is in an error mode (refer to Command Centre screen).

WHITE Flashing rapidly Sensors calibrating when power is first applied to the tap. Allow 10 seconds.

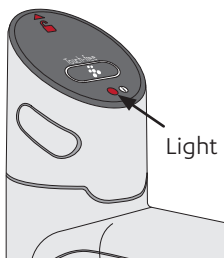

SECTION 2: Using the HydroTap

2.2 Touch-Free Wave continued

Dispense options



Sensor range 1 - 4cm.

To dispense, hold hand within range of the sensors.

Tap will not operate and light will flash if the sensors are touched or if your hand is too close.



Boiling



Boiling Water

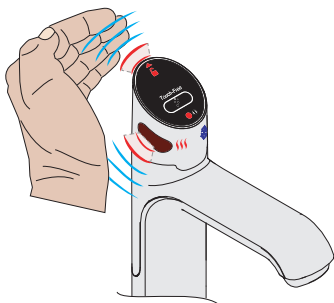

Chilled



Ambient

Side + Rear sensor:
Bottle fill
(timed dispense)



Sparkling

Top + Rear sensor:
Bottle fill
(timed dispense)

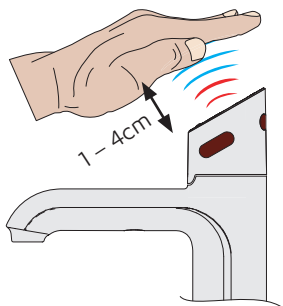

SECTION 2: Using the HydroTap

2.3 Arc / Arc Plus, Cube / Cube Plus and Celsius

Controls

Indicator displays system status.

Select touch to select water type.



Boiling



Chilled



Sparkling

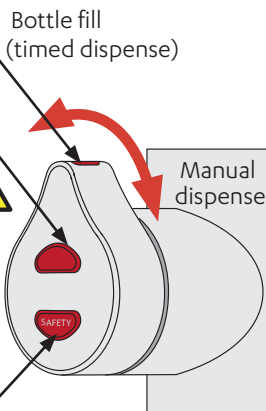

Safety When safety lock is on, touch twice to flash. Turn to dispense boiling water.

Lights



+



+



+

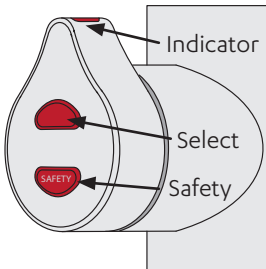

ON

Ready to dispense.

SINGLE COLOUR FLASHING SLOWLY

Water temperature not at set point.

SINGLE COLOUR FLASHING QUICKLY

System fault, refer to Command Centre LCD.



+



+



ALL LIGHTS FLASH EVERY 10 SECONDS

Filter change due.

SAFETY LOCK ON

SECTION 2: Using the HydroTap

2.4 Classic

Controls

Push for manual dispense
Pull for bottle fill (timed dispense)

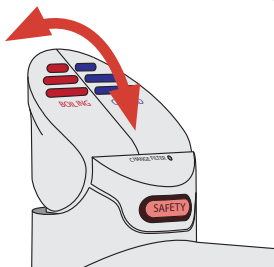

Lights

Boiling ready
Chilled / sparkling ready

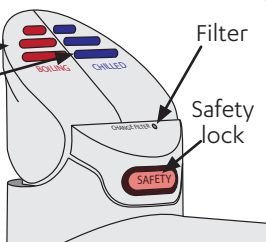

ON active
OFF inactive



ON
Ready to dispense.
FLASHING SLOWLY
Water temperature is not at set point

FLASHING QUICKLY
System fault

○ FILTER
OFF
Filter within lifespan.
FLASHING SLOWLY
Change filter.

Dispense options



Use boiling, chilled, sparkling, or ambient lever to dispense your water choice.

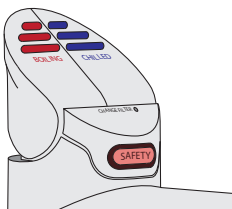

SECTION 2: Using the HydroTap

2.5 HydroTap Mixer taps

Controls mixed water

- Hot
- Cold

Lift and rotate the lever to dispense mixed warm water.

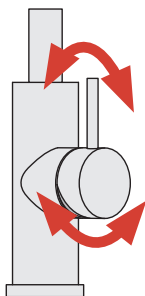
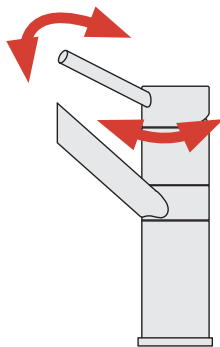

SECTION 3: Command Centre Screen

3.1 How to use the Command Centre screen

The Command Centre has a colour touch screen liquid crystal display.

The screen turns OFF after 5 minutes of non-use. Touch the screen to reactivate.

Navigate to the required screen. Here's an example :

Set the language - from the home screen

Touch the 'top left' icon to navigate to the main menu.

Then touch the general settings icon to navigate to the general settings menu.

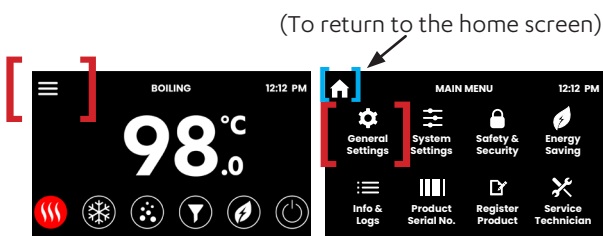

Touch the language icon to navigate to the language screen.

Touch the relevant language icon to select the language.

Touch the metric or imperial icon to select the units.

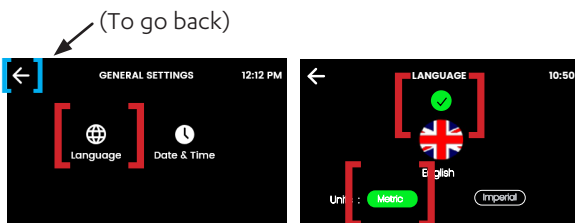

SECTION 3: Command Centre Screen

OFF screen

Touch the power button to turn the Command Centre ON or OFF. The LCD screen visually shows OFF when it is non-operational.

You will hear the sound of an internal “click” as the HydroTap Command Centre turns ON or OFF.

When OFF, all functions are disabled including heating, chilling, filling and dispensing.

Turning the power back ON will reset the system of any faults.



SECTION 3: Command Centre Screen

3.2 Home screen

Status screens shown here are representative and may vary. Use the home screen to monitor the HydroTap status. Touch each icon to view the system status.

Boiling temperature set point

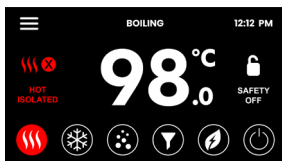

Chilled temperature set point (Chilled models)

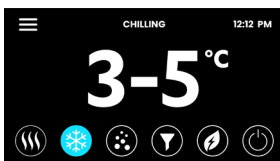

CO₂ gas remaining (Sparkling models)

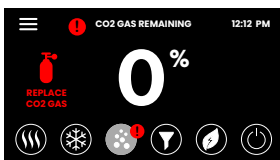
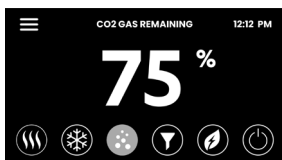

When the CO₂ cylinder has approximately 20% remaining, a warning appears to encourage you to prepare a replacement cylinder.

Filter life remaining

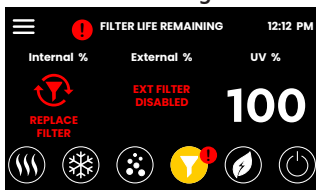

A warning icon is shown when the filter needs to be replaced. See page 35.

Energy saving settings

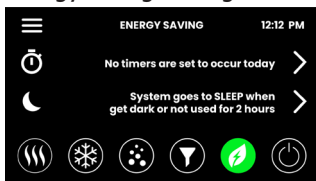

View or modify the current active timers and sleep mode actions. See page 31.

SECTION 3: Command Centre Screen

3.3 Main menu

Use the Main menu to configure your HydroTap and access features and settings. Touch each icon to access further options.

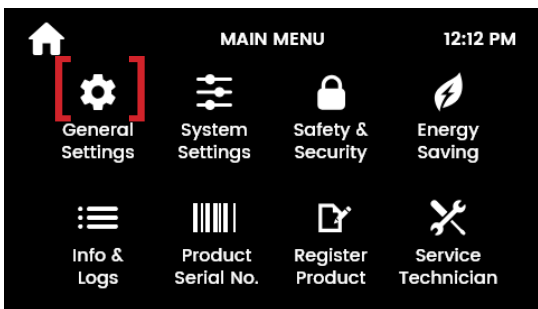

3.4 General settings

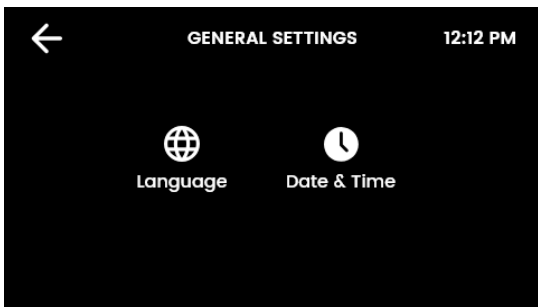

Language

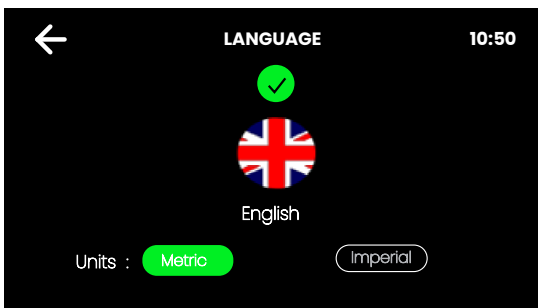

SECTION 3: Command Centre Screen

Date and time

Touch the text boxes on the screen and then press + and - to set the current date and time. Press the tick to confirm and save.

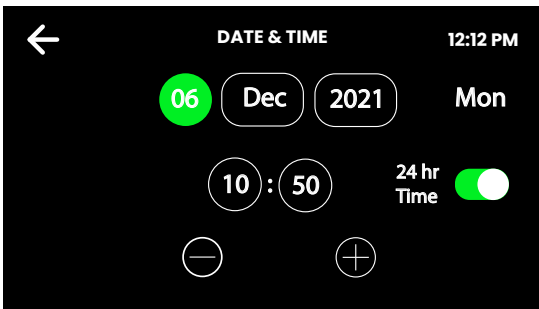

Network

Connect to Wi Fi (available with optional Zip Assist Kit).

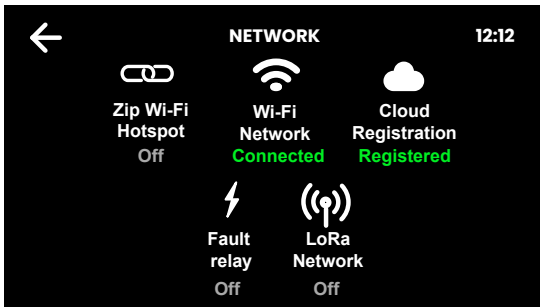

SECTION 3: Command Centre Screen

3.5 System settings

Configure your HydroTap to suit your needs.

Navigate to system settings screen for all system settings.

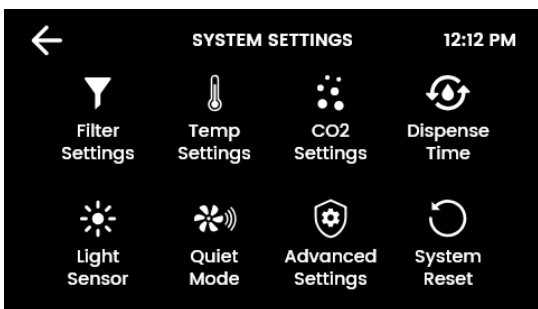
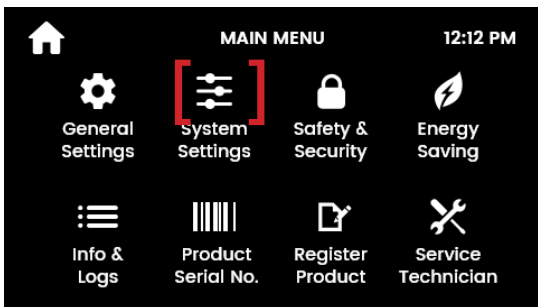

3.5.1 Filter settings

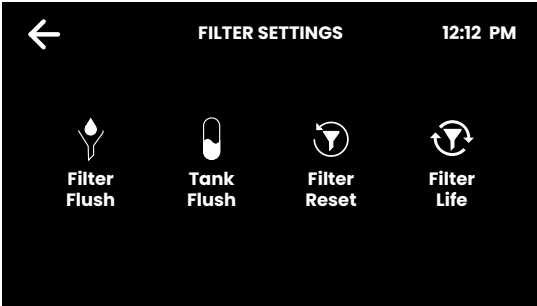

Filter flush

Use Filter flush during commissioning of a new installation, and after every filter change.

See page 35 for filter change instructions.

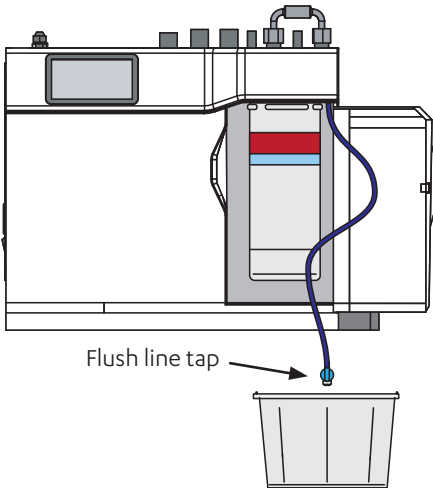

Open filter door, uncoil flush line.

Direct flush line into bucket.

Open flush line tap.

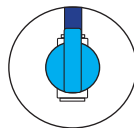

Flush line tap open

SECTION 3: Command Centre Screen

← **FILTER FLUSH** 12:12 PM

STEP 1.
Open the filter access door and turn the flush line STOP COCK VALVE to the ON position.

STEP 2.
Place a 3 gal bucket under the flush line valve to catch the water flushed through the filter.

▶

Start flush.

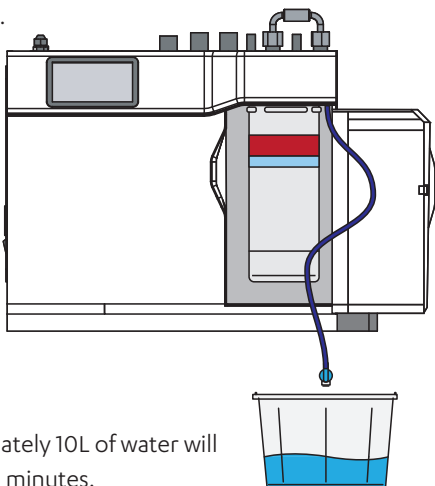

Approximately 10L of water will flow, for 2 minutes.

← **FILTER FLUSH** 12:12 PM

RUNNING.....
Water is now being flushed through the filter.
This process is automatic and will take 2 minutes.
Press pause to pause filter flush.

⏸

The screen will show the filter has been flushed.

Close the flush line tap, return the flush line to the filter compartment and close door.

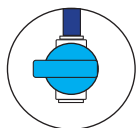

Flush line tap closed

Reset the filter counter (see page 19).

SECTION 3: Command Centre Screen

Filter reset

Reset the filter counters after filter replacement and flush.

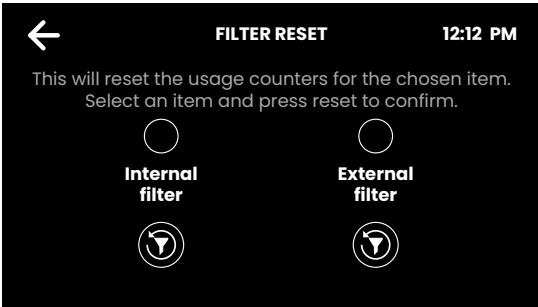

Filter life

Select internal/external filter and edit the filter life (months or litres) and actual usage (days or litres).

When usage exceeds the filter life, the tap lights and screen will indicate to change the water filter.

Default internal water filter life:

- Residential: 12 months or 4000L
- Commercial: 6 months or 6000L.

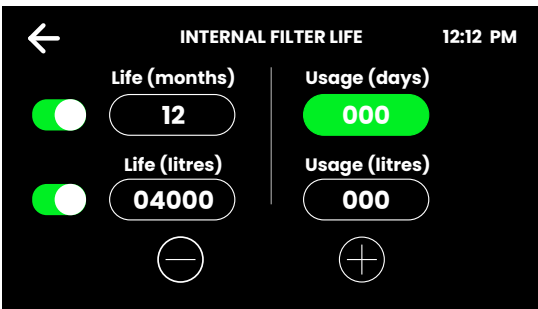

SECTION 3: Command Centre Screen

3.5.2 Temperature settings

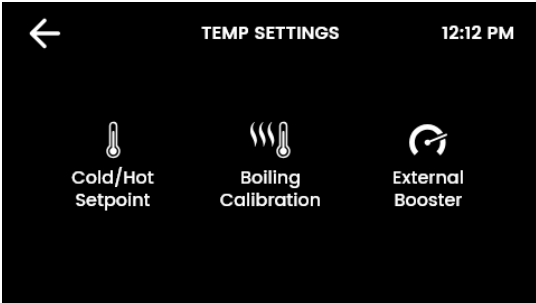

Boiling / Chilled set point

Adjust as required.

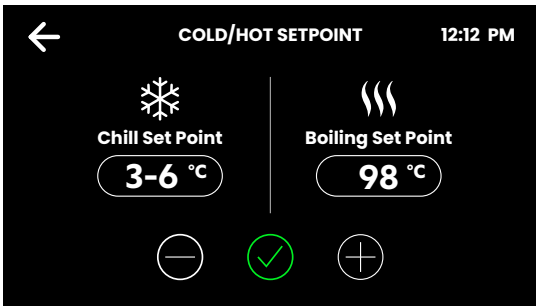

Chilled models

Default chill set point: 5-9°C Commercial, 6-10°C Residential.
Scroll to select alternatives.

Sparkling models

Chill set point: 3-6°C Commercial, 3-7°C Residential.
This set temperature is fixed, for sparkling optimisation.

Boiling models

Default set point: 98°C Set point range: 68-100°C.
Operation: Within 1-2°C of set point.

Note: Boiling water delivery rate will be affected with a higher temperature setting. Up to 6% less energy in standby is consumed with a 98°C set point, rather than 100°C.

A warning icon will appear when setting boiling set point temperatures that are subject to pump cavitation.

SECTION 3: Command Centre Screen

Boiling calibration



Take care during boiling calibration as hot steam may vent from the tap spout.



On start-up, the HydroTap self-calibrates, or go to this menu to recalibrate.

Calibration will take around 10 minutes.

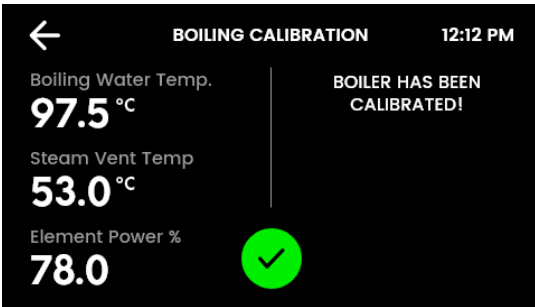

External Booster

For selected commercial Boiling models, an external booster is supplied or may be purchased as an upgrade to increase Boiling capacity.

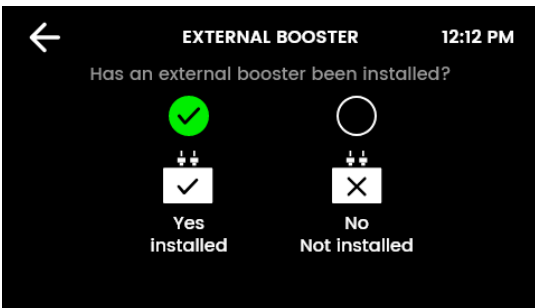

Ensure the correct selection is made, for optimum performance.

SECTION 3: Command Centre Screen

3.5.3 CO₂ settings

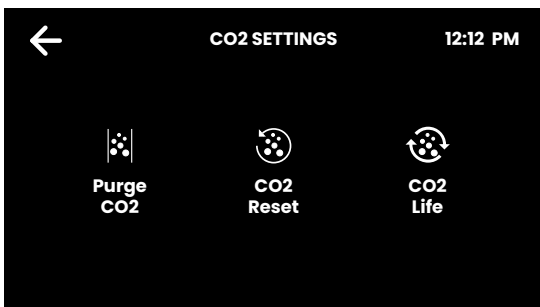

CO₂ purge

Purge the gas lines when fitting a new CO₂ gas cylinder. Press the green start icon. The purge runs for 30 seconds. Water may be dispensed before CO₂ gas escapes from the tap. The purge process stops automatically.

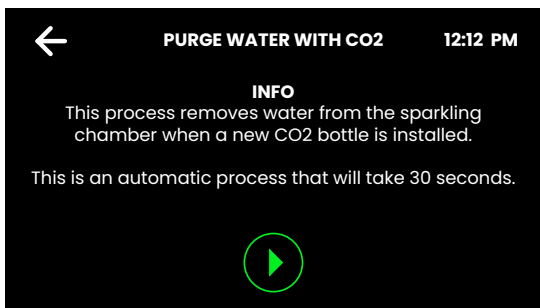

CO₂ reset

After fitting a new CO₂ cylinder, reset the CO₂ counter.

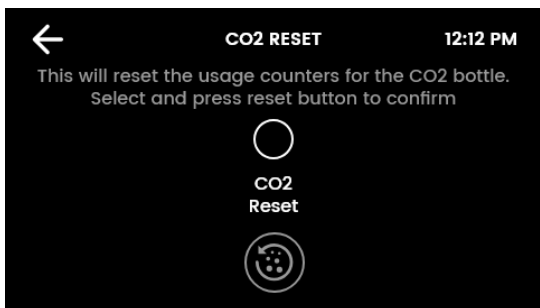

SECTION 3: Command Centre Screen

CO₂ life

CO₂ life may be adjusted by months or litres. The Home screen displays a warning when the CO₂ level reaches 20% (see page 14).

CO₂ life defaults to grams absorbed. Months of use may also be selected to trigger a reminder to prepare a replacement CO₂ cylinder.

Usage is dependent on CO₂ absorption, settings on the HydroTap, and leak-free installation.

CO₂ cylinders are available in two sizes:

- 1.2kg (approx. 180-200L) for residential or commercial (UK).
- 2.64kg (approx. 400-460L) for commercial (not available in UK).

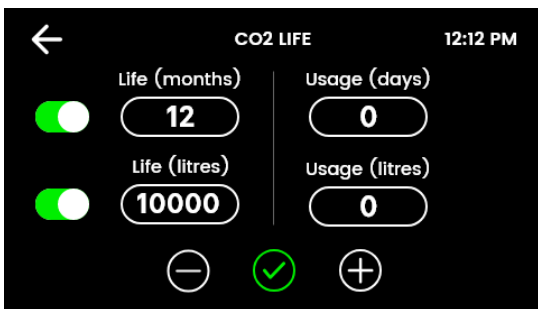

SECTION 3: Command Centre Screen

3.5.4 Dispense times

Set the “bottle fill” dispense time for each water type.

Minimum dispense time: 5 seconds.

Maximum dispense time: 15 seconds (default).

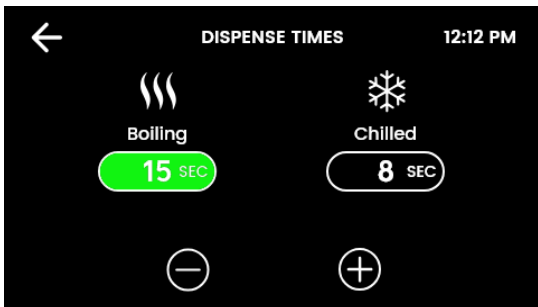

3.5.5 Light sensor

Follow the on screen instructions.

Ensure the ambient light in the room is typical for operating conditions.

The lights on the tap will flash to confirm calibration.

When the room is darkened below the calibrated light level, the tap lights will turn OFF after 30 seconds. Energy saving modes may occur. Refer to section 3.7 (page 31).

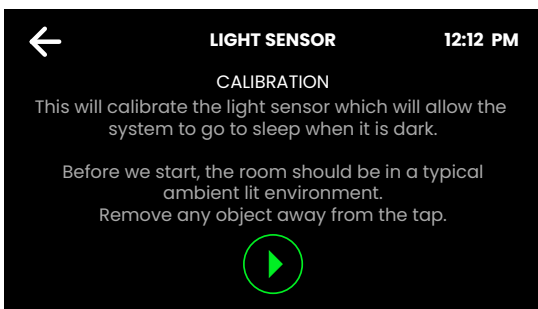

SECTION 3: Command Centre Screen

3.5.6 Quiet mode

Lowering the fan speed can reduce noise. Increasing it may improve chilling performance.

Residential models: 75% / 100% / Auto (default).

Commercial models: 100% (default) / Auto.

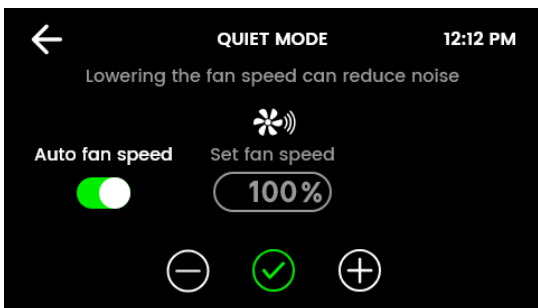

3.5.7 Advanced settings 1

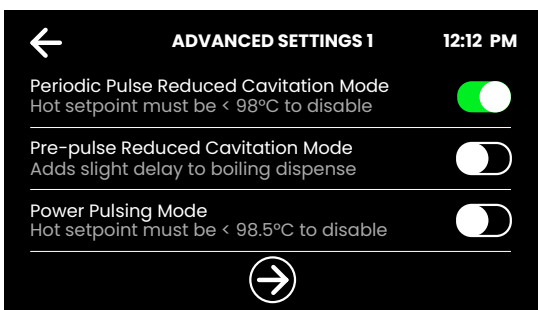

Periodic Pulse Reduced Cavitation Mode

Sends two electric pulses every 5 minutes to the pump. This prevents the build-up of air bubbles inside the pump to ensure an even flow of hot water at the tap.

Pre-Pulse Reduced Cavitation Mode

Pulses immediately before boiling dispense to prevent the build-up of air bubbles inside the pump and ensure an even flow of hot water at the tap. There will be a 150 millisecond delay before water is dispensed.

Power Pulsing Mode

Applies a closer tolerance to the set temperature, to ensure hot water is maintained as closely as possible to the set point.

SECTION 3: Command Centre Screen

3.5.8 Advanced settings 2 (Wave Tap only)

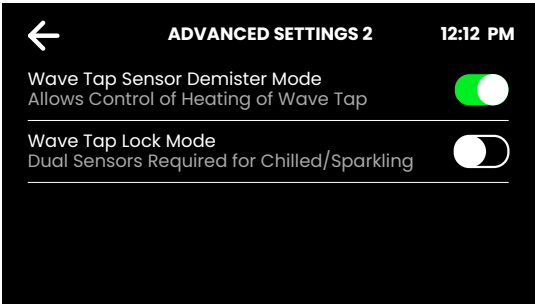

Wave Tap Sensor Demister Mode

- Enabled (default): activates the Wave Tap internal heater to prevent its sensors from being affected by condensation from steam.
- Disabled: choose this option to conserve a small amount of power.

Wave Tap Lock Mode

- Disabled (default): Chilled or sparkling water can be dispensed by activating the corresponding sensor.
- Enabled: in addition to the chilled or sparkling sensor, the rear sensor must also be activated in order to dispense chilled or sparkling water. This is useful to prevent false activation if a highly reflective surface is present (such as high-visibility reflective tape). Note: Bottle fill is disabled.

3.5.9 System restart

Touch the top circle, then the bottom circle to power down and restart the system. Use this function to reset faults or to reset the settings access password.

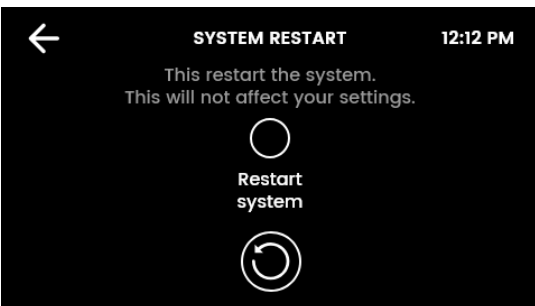

3.6 Safety & security



3.6.1 Boiling safety

(Not applicable to Touch-Free Wave Tap)

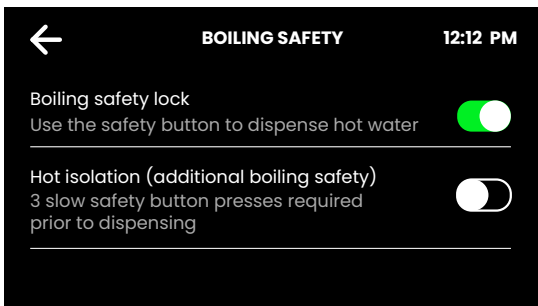

Boiling safety lock

- Enabled (default): safety button must be touched/tapped in order to dispense boiling water.
- Disabled: boiling water can be dispensed without the need to touch/tap the safety button.

Hot isolation

3 slow safety button presses are required prior to dispensing.

SECTION 3: Command Centre Screen

3.6.2 Passcode protect

Activate passcode protection to limit access to certain settings. Users will be prompted for this passcode when attempting to access settings.

Create a 4-digit passcode and re-enter, as prompted.

The passcode will be deactivated if the HydroTap is reset (powered off and on again).

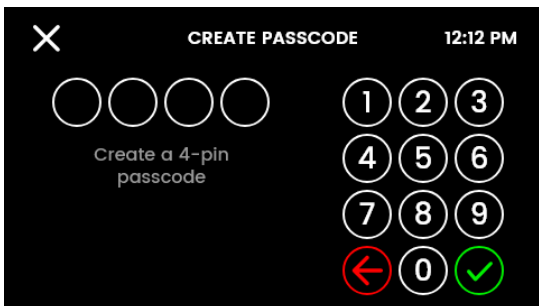

SECTION 3: Command Centre Screen

3.7 Energy saving



3.7.1 Sleep mode

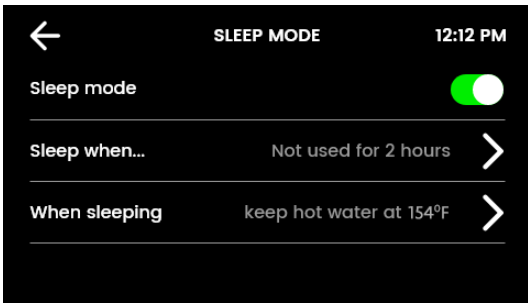

- Disabled (default).
- Enabled: Any attempt to dispense water will bring the HydroTap out of sleep mode. Allow sufficient time for the water to reach the set temperature.

Sleep when...

Select from: It gets dark / Not used in 2 hours / Both

Recalibrate the light sensor after selecting sleep when “it gets dark”. Ensure the ambient light is typical for operating conditions (see page 26).

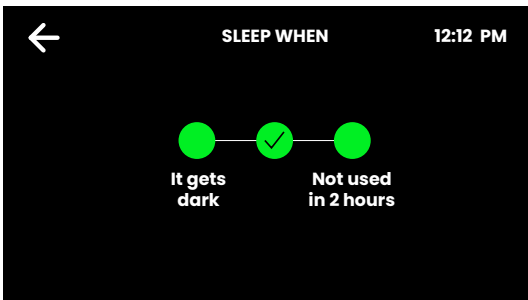

SECTION 3: Command Centre Screen

When sleeping

Choose between the following modes:

- Keep hot water at 68°C (default). Chilled water will be kept at setpoint, for chilled models.
- Turn system OFF: boiling and chilled water will be OFF.

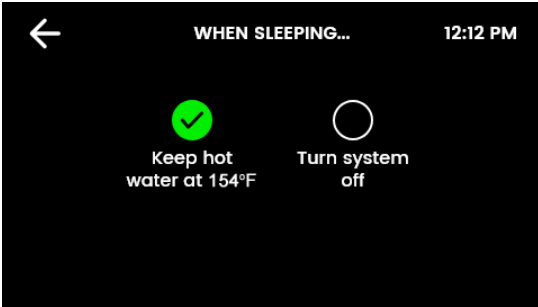

3.7.2 On/Off Timer

The option that is in effect is highlighted.

When OFF, the HydroTap will stop chilling and heating the drinking water.

During OFF mode, any attempt to dispense water will bring the HydroTap back ON. Allow sufficient time for the water to reach the set temperature.

After 30 minutes of non-use, the system will revert to the On / Off setting.

Set Timer

The off/on timer can be set to the same time every day, on a range of days (weekdays/weekends), or by individual days.

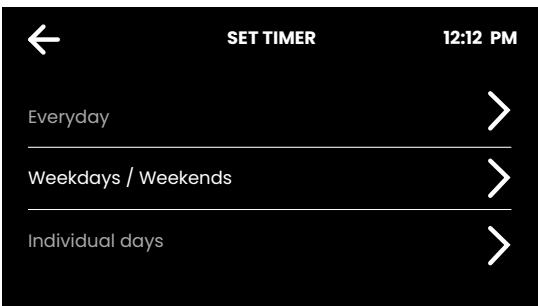

SECTION 3: Command Centre Screen

3.7.2 On/Off Timer continued

Select the day or range of days, then set the desired Off/On times. Touch the tick to confirm and save.

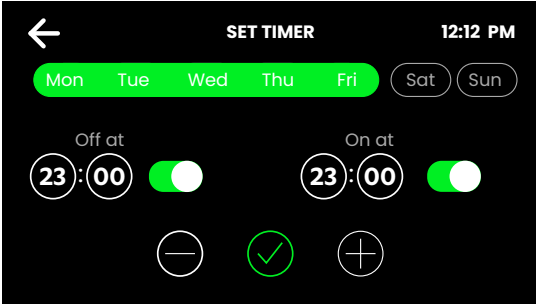

3.7.3 Energy Use

Track energy usage of your HydroTap by viewing the total energy consumed and the energy consumed since the last energy use reset.

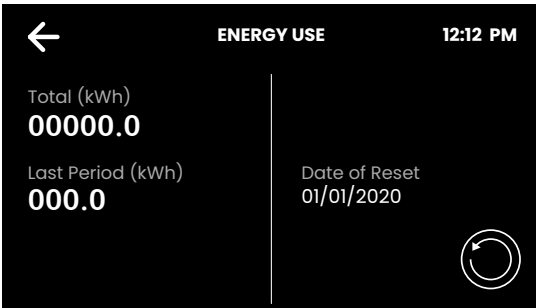

The bottom right button is used to reset the 'last period' usage counter.

SECTION 3: Command Centre Screen

3.8 Info & logs

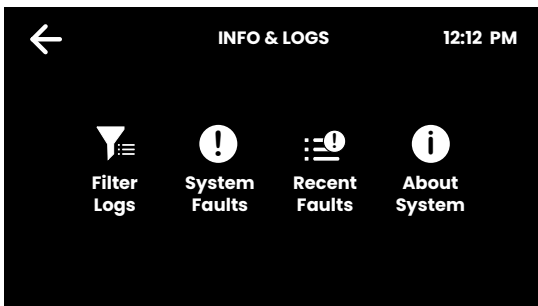

Filter Logs, System Faults, Recent Faults

View the filter reset history, current and recent fault history.

About System

View the system information.

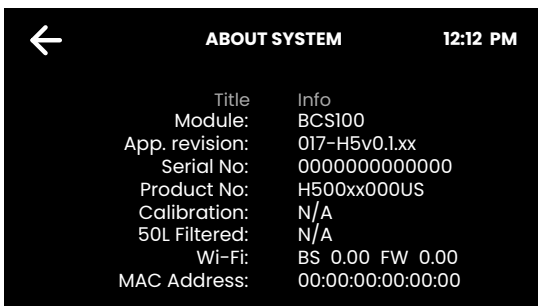

SECTION 4: User maintenance

4.1 Changing the internal filter

The tap and screen will indicate that a filter needs to be changed.

Depending on local water quality conditions and usage, the filter may require changing before the filter change indication is shown. You may also need to replace the filter if you notice an increase in chlorine, taste or odour.

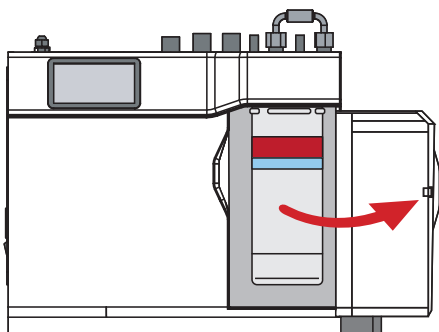

Open filter door.

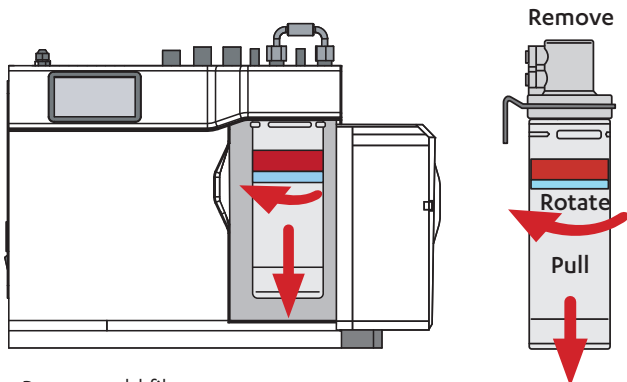

Remove old filter.



Place a cloth or towel under the filter cartridge before removing. Water will drip as the cartridge is removed.

Unpack replacement cartridge and remove sanitary cap.

Write today's date on the label.

SECTION 4: User maintenance

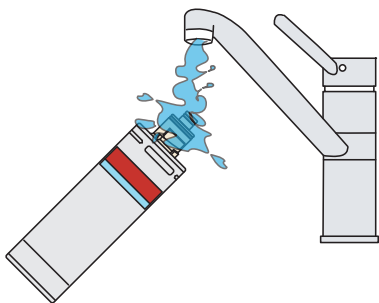

Moisten connector o-rings.

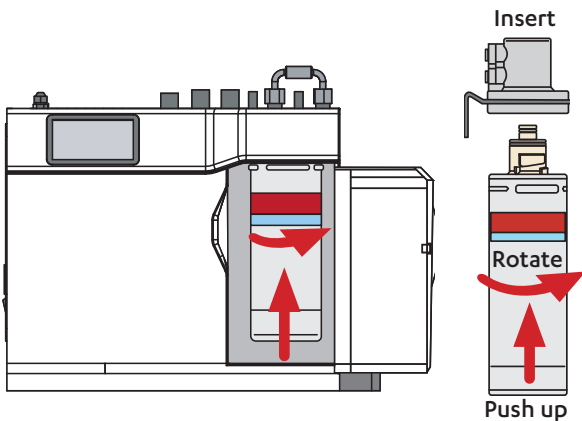

Fit new filter.

Initiate the filter flush programme by scrolling through the menu screen (see page 19).

Clean up and dispose of old cartridge and packaging.

If the HydroTap is switched off for a long period of time (e.g. more than a weekend), run water through the chilled water outlet for at least 60 seconds before consumption.

SECTION 4: User maintenance

4.2 Air inlet filter maintenance

Remove and clean quarterly.

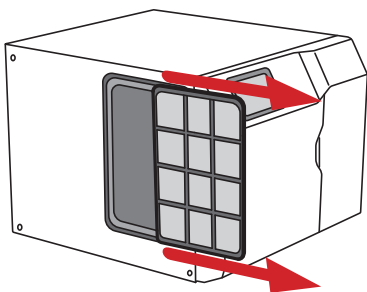

Rinse off with tap water.



Gently dry with a cloth or towel.

Maintain at least a 50mm air gap in front of the air inlet screen at all times.

Take care to keep the air inlet clear of blockage.

4.3 Cleaning



To clean all taps, Command Centre and ancillaries, wipe external surfaces with a gentle cleaning agent or a damp cloth and then wipe dry immediately with a clean, dry cloth.



Do not use strong, corrosive, spray or abrasive cleaners.

Command Centres must never be located near or cleaned with water jets.



For the Touch-Free Wave Tap:

Do not use abrasives to clean the sensor lenses at the sides, top and rear of the Touch-Free Wave Tap.

Do not use disinfectant sprays without wiping dry afterwards.

This could cause permanent malfunction and void warranty.

SECTION 4: User maintenance

4.4 CO₂ cylinder and regulator



Significant concentrations of CO₂ gas can cause harm.



To prevent leaks, read and use the instructions and safety documents provided with the replacement cylinder, together with these instructions.

Components

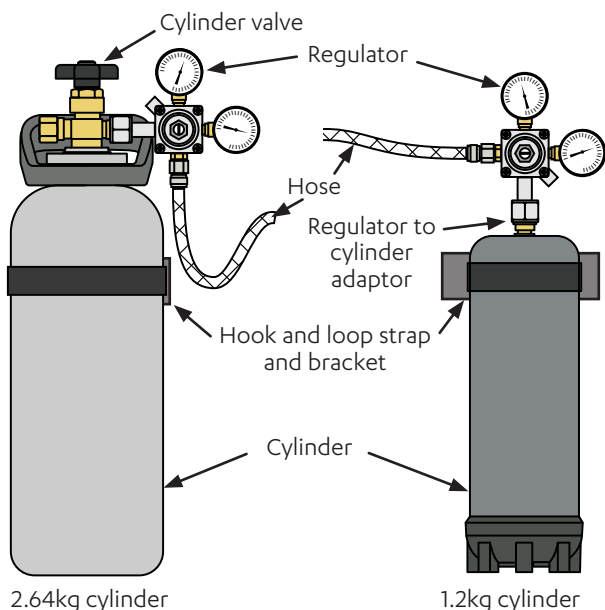

Non-adjustable 1.2kg cylinder regulator

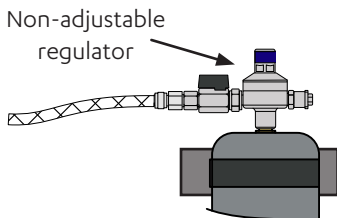

SECTION 4: User maintenance

Universal G5 CO₂ regulator

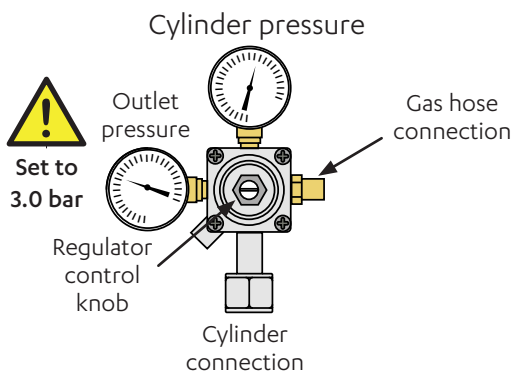

1.2kg cylinder non-adjustable regulator

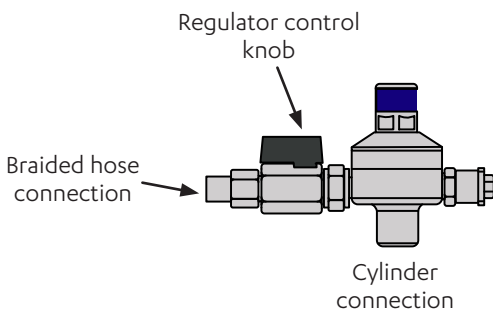

SECTION 4: User maintenance

4.4.1 Changing the 2.64kg CO₂ cylinder

1

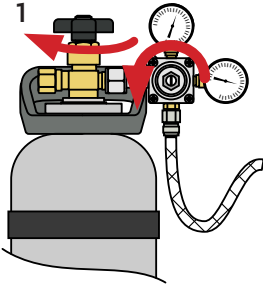

Turn off cylinder valve & regulator.

2

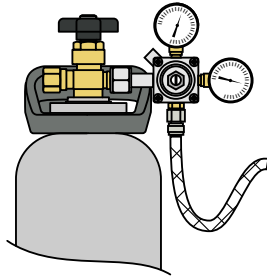

Unstrap.

3

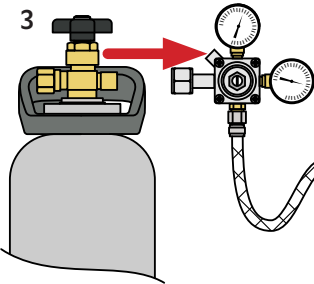

Unscrew regulator connection.

4

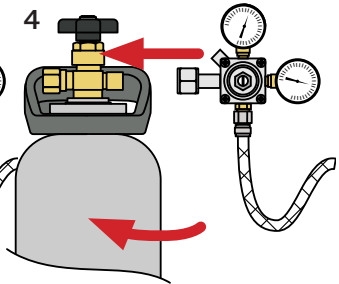

Replace cylinder and refit regulator.

5

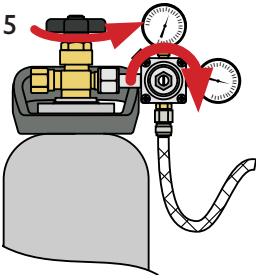

Turn on the cylinder valve
Adjust outlet pressure 3.0 bar.

6

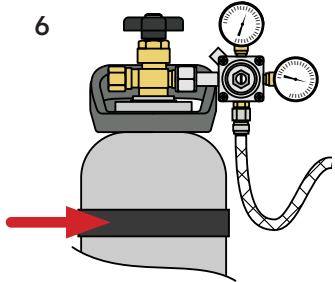

Strap in place.

7

Test for leaks by brushing with soapy water and looking for bubbles.

Reseal if leaking, or call Zip for advice and assistance.

8

Purge, reset and set the CO₂ life, (see page 24).

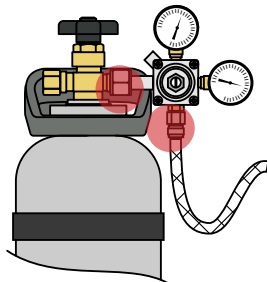

● Test for leaks in these areas

SECTION 4: User maintenance

4.4.2 Changing the 1.2kg CO2 cylinder

Universal G5 regulator

1

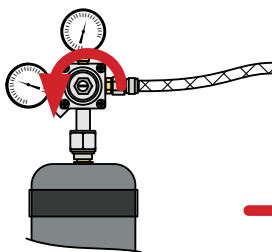

Turn off regulator.

2

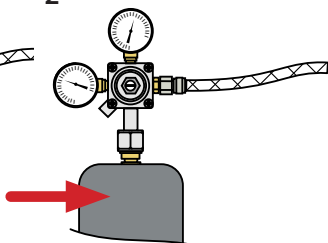

Unstrap.

3

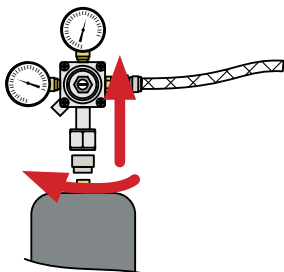

Unscrew regulator connection.

4

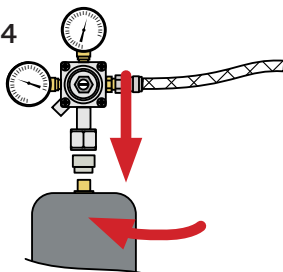

Replace cylinder and refit regulator inc. adaptor.

5

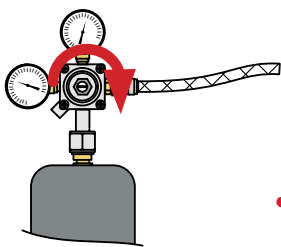

Adjust outlet pressure 3.0 bar.

6

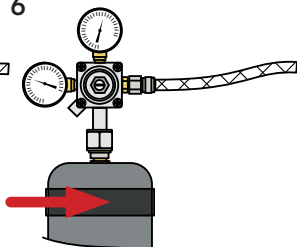

Strap in place.

7

Test for leaks by brushing with soapy water and looking for bubbles.

Reseal if leaking, or call Zip for advice and assistance.

8

Purge, reset and set the CO₂ life, (see page 24).

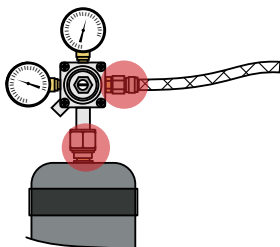

● Test for leaks in these areas

SECTION 4: User maintenance

Non-adjustable regulator

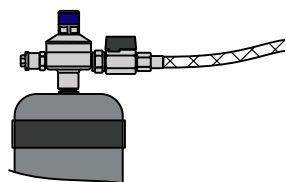
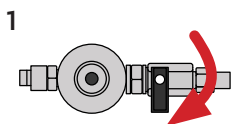

Turn off regulator.

2

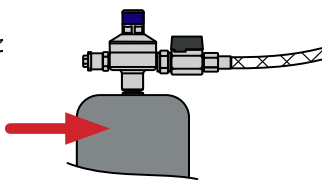

Unstrap.

3

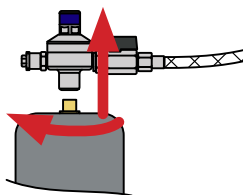

Unscrew regulator connection.

4

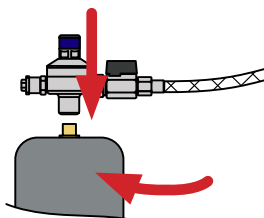

Replace cylinder and refit regulator.

5

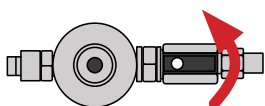

Turn ON regulator valve.

6

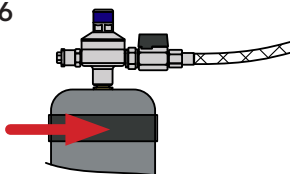

Strap in place.

7

Test for leaks by brushing with soapy water and looking for bubbles.

Reseal if leaking, or call Zip for advice and assistance.

8

Purge, reset and set the CO₂ life, (see page 24).

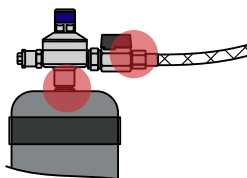

● Test for leaks in these areas



Zip Water

ABN 46 000 578 727

67 - 77 Allingham Street, Condell Park, NSW 2200

Postal: Locked Bag 80, Bankstown 1885, Australia

(+612) 9796 3100 | Free Call (Aust): 1800 947 827

www.zipwater.com



Zip Water UK

Trafalgar House

Rash's Green, Dereham,

Norfolk NR19 1JG

0345 6 005 005

sales@zipindustries.co.uk

specify.zipwater.co.uk



As Zip policy is one of continuous product improvement, changes to specifications may be made without prior notice. Images in this booklet have been modified and may not be true representations of the finished goods.

The terms "Zip" and "HydroTap" are registered trade marks of Zip Heaters (Aust) Pty Ltd.