



Instructions for use COMBI MICROWAVE OVEN

OCM8478G / BO4CM4T2-42

Pictograms used



Important information



Tip

CONTENTS

Your oven

Introduction	4
Control panel	5
Description	6
Guide rails/Telescopic guide rails	6
Accessories	6
Door	7
Cooling fan	7
Touch screen	8
Main displays	8
Function-setting display	11
Stand-by display	12

Initial use

Initial use	13
-------------	----

Operation

Using the 'Plus' menu	15
Opening the keyboard	17

Use

Oven function	18
Using the microwave	20
Microwave function	22
Using the 'Extras' functions	23
Functions table	27
Delayed start	32
Stage cooking	33
Gratin	35
Additional functions	36
Settings	40

Cleaning

Cleaning the appliance	42
Steam clean	42
Removing and cleaning the guide rails	43
Replacing the oven lamp	44

Solving problems

General	45
---------	----

Your oven and the environment

Disposal of the appliance and packaging	47
---	----

Introduction

Congratulations on choosing this Asko combi microwave oven. This product is designed to offer simple operation and optimum user-friendliness. The oven has a wide range of settings enabling you to select the correct cooking method every time.

This manual shows how you can best use this oven. In addition to information about operating the oven, you will also find background information that may be useful when using the appliance.



Please read the separate safety instructions carefully before using the appliance!

Read this manual before using the appliance and keep it in a safe place for future use.

Installation instructions are supplied separately.

Control panel

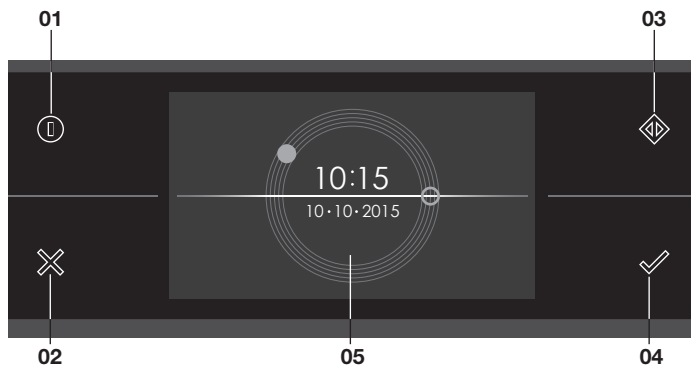

01. On/Off key; use to:

- switch on the appliance.
- switch to stand-by
- switch off the appliance. Keep the 'On / Off' key pressed until the appliance switches off.

02. X key; use to:

- go a step back in the menu.
- close or answer 'No' to a pop-up.
- close or cancel a menu or function.

03. Quick start; use to:

- switch on the microwave function directly (from the start or 'Extras' menu or the various function menus). Touching the display more often adds extra time. Microwave power and the added cooking times can be adjusted in the settings menu.

04. Confirm key; use to:

- confirm settings
- start a function.
- close or answer 'Yes' to a pop-up.

05. Touch screen/display

YOUR OVEN

Description

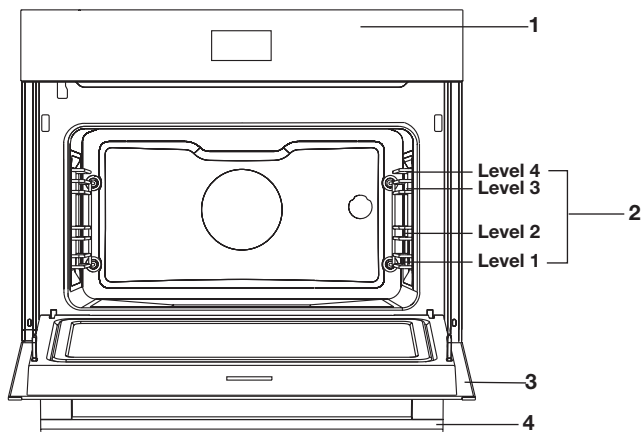

1. Control panel
2. Shelf levels
3. Oven door
4. Door handle

Guide rails/Telescopic guide rails

- The oven has four or five guide rails (Level 1 to 4/5), depending on the model. Level 1 is mainly used in combination with bottom heat. The two upper levels are mainly used for the grill function.
- Place the oven rack, baking tray or steam dish in the gap between the guide rail sliders.
- A number of shelf levels can have fully-retractable telescopic guide rails, depending on the model.
 - Pull the telescopic guide rails out of the oven cavity completely and place the oven rack / baking tray / steam dish on them. Then slide the oven rack / baking tray / steam dish on the telescopic guide rails, back into the oven cavity.
 - Only close the oven door when the telescopic guide rails have been returned completely back into the oven cavity.

Accessories



Your appliance is accompanied by a range of accessories, depending on the model. Only use original accessories; they are specially suited to your appliance. Be sure that all the accessories that are being used

YOUR OVEN

are able to withstand the temperature settings of the chosen oven function.

Note: not all accessories are suitable/available for every appliance (it may also differ by country). When purchasing, always provide the exact identification number of your appliance. Please see the sales brochures or check online for more details about optional accessories.

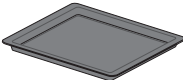
Note: never place an accessory on the bottom of the oven!

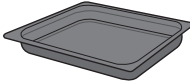
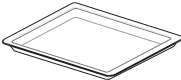
Accessories that can be supplied with your appliance (depending on the model)	
	Enamelled baking tray; to be used for pastries and cakes. <ul style="list-style-type: none">• Do not use the enamelled baking tray for microwave functions!• Suitable for pyrolysis cleaning.
	Oven rack; mainly used for grilling. A steam dish or pan with food can also be placed on the oven rack. <ul style="list-style-type: none">• The oven rack is equipped with a safety peg. Lift the rack slightly at the front to slide it out of the oven.• Do not use the oven rack for microwave functions!
	Deep enamelled baking tray; to be used for roasting meat and baking moist pastry. <ul style="list-style-type: none">• Do not place the deep baking tray on the lowest level during a cooking process, except when using it as a drip tray during grilling, roasting or roasting with a spit roast (when available).• Do not use the deep enamelled baking tray for microwave functions!• Suitable for pyrolysis cleaning.
	Glass baking tray; for microwave and oven use. <ul style="list-style-type: none">• NOT suitable for pyrolysis cleaning.

Door

- The door switches interrupt the operation of the oven when the door is opened during use. The oven continues operating when the door is closed.
- This oven has a 'Soft close door system'. When closing the oven door, this system dampens the movement, from a certain angle, and silently closes the oven door.

Cooling fan

- The appliance is equipped with a cooling fan that cools the casing and control panel.

YOUR OVEN

Touch screen

- Operate your oven's touch screen by tapping or swiping it.
- Tap the display to open a function or adjust a setting.
- Swipe the display for further information/show options or adjust a setting.

Tapping:

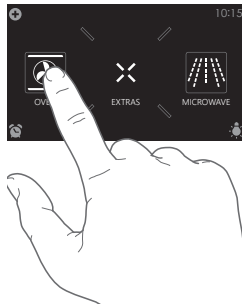

Swiping:

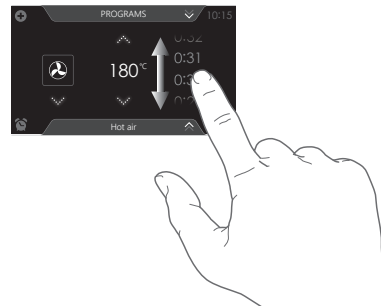

For the best response, touch the keys with the main part of your fingertip. Every time you tap a key during use, a short tone will sound (unless this is adjusted in the settings).

Main displays

Start display

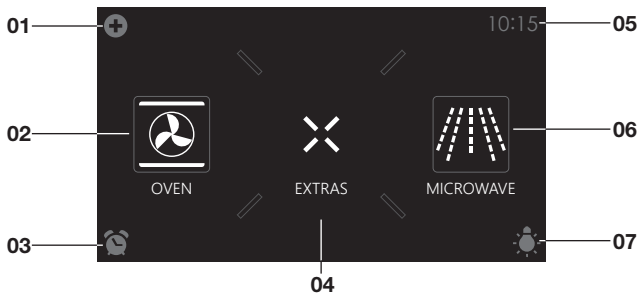

Plus menu (01)

- Tap the plus symbol to open the 'Plus' menu. The contents of this menu change according to the control options available at that time.

Oven (02)

- Tap 'OVEN' to open the oven function menu.

Egg timer (03)

- Tap the egg timer symbol to open the egg timer menu. The egg timer can be used independently from the oven function.
 - The longest possible alarm time is 24 hours.
 - When the egg timer has finished, a pop-up will appear and a sound signal sounds.
 - Tap on the X key, confirm key or the display to switch off the signal and close the pop-up. The sound signal will stop automatically after approximately 1 minute.

Extras (04)

- Tap on 'EXTRAS' to show the appliance's extra functions.

Time (05)

- The time is shown here.

Microwave (06)

- Tap on 'MICROWAVE' to open the microwave function.

Lighting (07)

- Tap on the 'lamp' symbol to switch the oven light on or off.
- The oven light will also light up when you open the oven door or start cooking. The oven light will dim automatically (unless this is adjusted in the settings).

Extras display

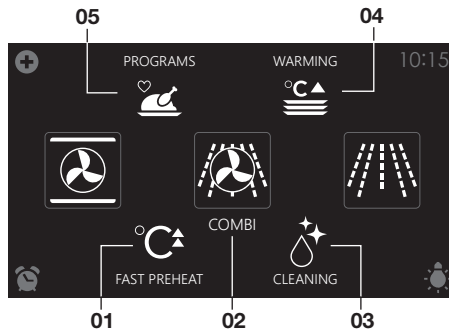

Fast preheat (01)

- Tap on 'FAST PREHEAT' to open the fast preheat function.

Combi (02)

- Tap on 'COMBI' to open the combi function menu.

Cleaning (03)

- Tap on 'CLEANING' to open the cleaning function.

Warming (04)

- Tap on 'WARMING' to open the warming function menu.
Plate warming, defrost and keep warm can be found here.

Programs (05)

- Tap on 'PROGRAMS' to open the programs menu. The favourites and automatic programs can be found here.

Function-setting display

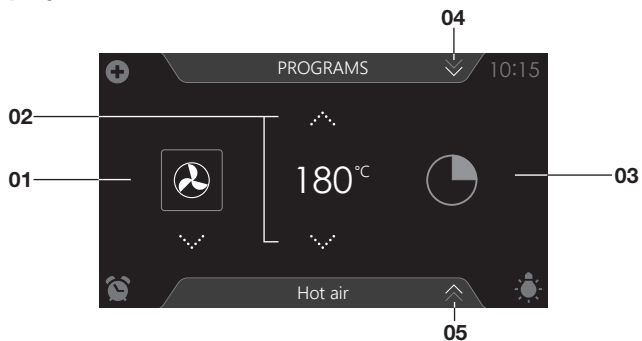

Selecting a function (01)

- Tap on the arrows above and below the function or sweep over the symbol to select a function (see also 'Opening the Keyboard').

Setting temperature/power (02)

- Tap on the arrows above and below the temperature/power or sweep over the temperature/power indicator to select a temperature or power (see also 'Opening the Keyboard').

Cooking time (03)

- Tap the cooking time symbol if you want to set a cooking time. If a cooking time is already stated, it is necessary to set this.
- Tap on the arrows above and below the time or swipe over the time to adjust it (see also 'Opening the Keyboard').

Programs (04)

- Tap on 'PROGRAMS' to open the program menu. The favourites and automatic programs can be found here.

Info tab (05)

- The name of the selected function appears in the bottom tab of the display. Tap on the tab to request more information about the selected function.

Stand-by display

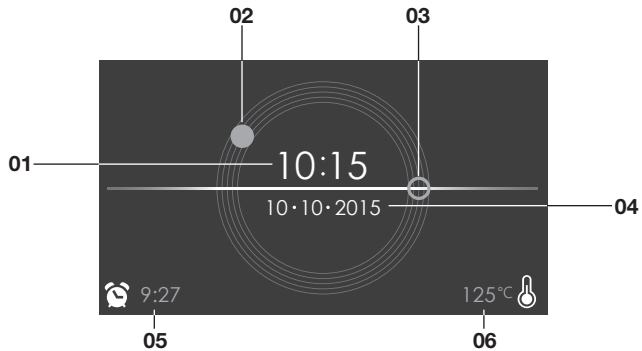

Display time (digital/01)

- Actual time of day.

Display time (analog/02 and 03)

- Actual time of day.
- The hour hand of the analog clock is indicated with a 'closed' circle (02) and the minute hand with an 'open' circle (03).

Display of date (04)

- Actual date.

Display egg timer (05)

- The expiring egg timer.

Display descending temperature (06)

- Actual temperature in the oven (waste heat).

INITIAL USE

Initial use

- Clean the oven interior and accessories with hot water and washing-up liquid. Do not use aggressive cleaning agents, abrasive sponges and similar.
- The oven will emit a particular odor when it is used for the first time; this is normal. Make sure that there is good ventilation during initial use.

When the appliance is plugged in for the first time or after the appliance was disconnected from the mains for a longer period of time, you have to set 'Language', 'Time' and 'Date'

Setting the language

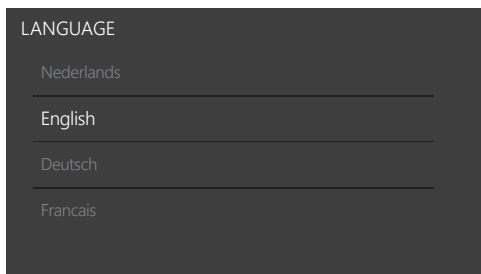

Set the desired language in which the appliance's display texts will appear. 'English' is selected as standard.

1. Swipe over the display to view all languages.
2. Tap on a language to select this.
3. Press on the confirm key to save the set language.



Setting the time

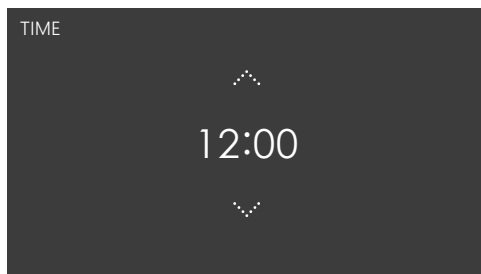

1. Tap on the arrows above and below the time or swipe over the time to adjust it.
2. For fast entry, tap in the centre of the time display; a pop-up keyboard will appear on which the desired time can be typed (see 'Opening the Keyboard' chapter).
3. Press on the confirm key to save the set time.



Setting the date

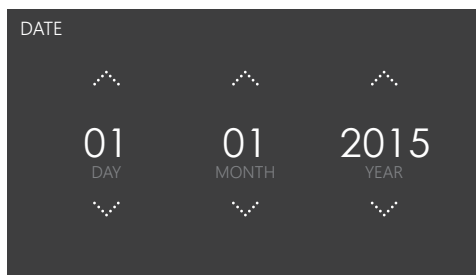

1. Tap on the arrows above and below the day, month or year or swipe over the day, month or year to adjust these.
2. Press on the confirm key to save the set date.



The appliance is now ready for use.



The language, time and date can be adjusted in the settings menu (see 'Settings' chapter). The settings menu can be opened from the start display via the 'Plus' menu.

Using the 'Plus' menu

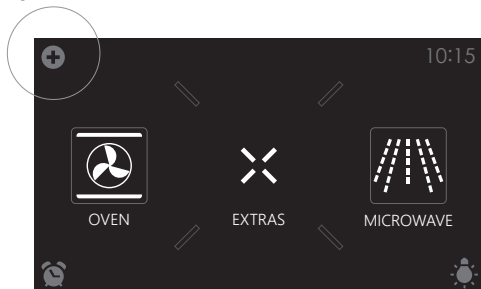

The 'Plus' menu comprises a number of functions or settings. The offered plus functions depend on the display that is active.

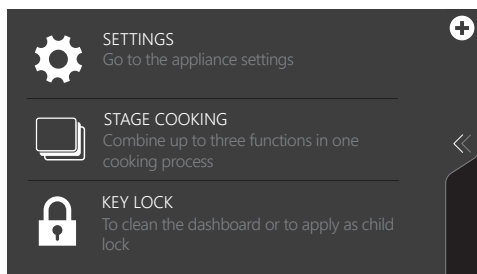

- From the start display, the following functions/menus can be found in the 'Plus' menu:
 - **Settings;** Set your preferences (see 'Settings' chapter).
 - **Stage cooking;** Combine up to three functions in one cooking process (see 'Stage cooking' chapter).
 - **Key Lock;** Lock all the keys to clean the dashboard or to prevent that the appliance gets into progress accidentally. Hold the function pressed until the key lock is enabled.

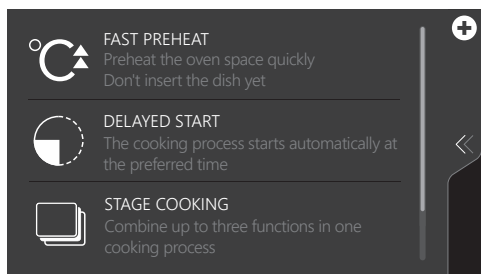

- From the oven, microwave or combi function-setting display, the following functions can be found in the 'Plus' menu:
 - ▷ **Fast preheat;** Preheat the oven space quickly to the desired temperature within a cooking process (see 'Fast preheat' chapter) Only from oven function-settings display.
 - ▷ **Delayed start;** The cooking process will start automatically at the time you set (not available for microwave function).
 - ▷ **Stage cooking;** Combine up to three functions in one cooking process (see 'Stage cooking' chapter).
 - ▷ **Key Lock;** Lock all the keys to clean the dashboard or to prevent that the appliance gets into progress accidentally. Hold the function pressed until the key lock is enabled.
 - ▷ **Gratin;** To add the grill function at the end of the progress (gratin time will be added at the end of the cooking process).

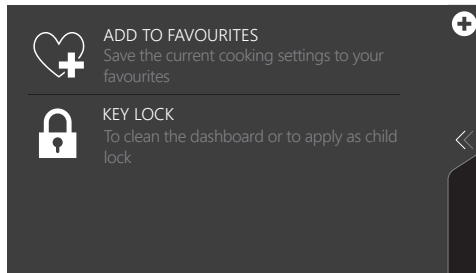

- When an oven, microwave or combi function is started, the following functions can be found in the 'Plus' menu:
 - ▷ **Add to favourites;** Add the settings for the cooked dish to your favourites (see 'Additional functions' chapter).
 - ▷ **Key Lock;** Lock all the keys to clean the dashboard or to prevent that the appliance gets into progress accidentally. Hold the function pressed until the key lock is enabled.
 - ▷ **Gratin;** To add the grill function at the end of the progress (gratin time will be added at the end of the cooking process).

Opening the keyboard

A keyboard can be opened for fast entry of a function, temperature, power or cooking time. A quick setting can be selected with this or a value can be entered.

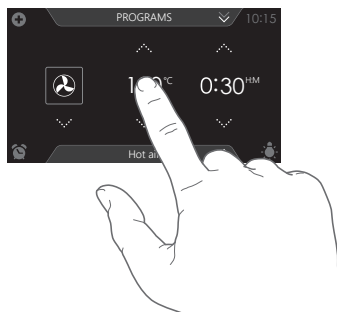

1. Tap in the centre of the function symbol, temperature, power or cooking time (activated). The keyboard appears.

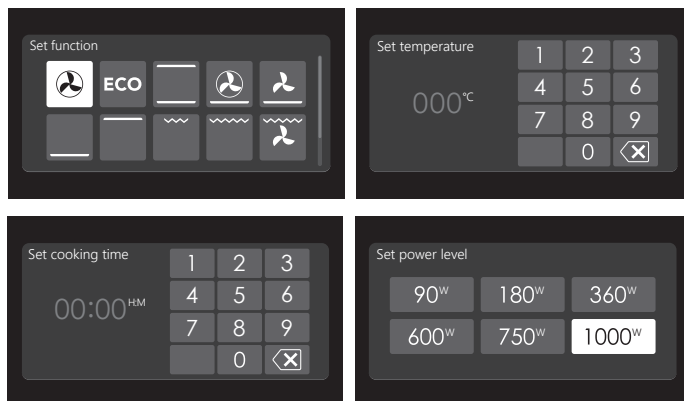

2. Enter the desired value or tap the desired value.
3. If the set value is not confirmed automatically, press on the confirm key to confirm the entry.

Oven function

Use the oven functions to cook dishes using, for instance, hot air, bottom heat and grill.

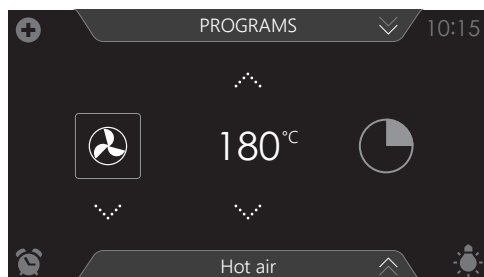

- Various oven functions can be selected.
- A temperature and a cooking time can be set for each oven function.
- Plus functions such as preheat, stage cooking and delayed start can also be selected. Tap on the plus symbol for this. See the 'Using the 'Plus' menu' chapter.

Using an oven function

Select the oven function appropriate for the meal you are cooking. Consult the Functions table for this. You can also consult the info tab. Tap on the tab at the bottom of the display to request more information about the selected function.

1. Switch on the oven using the 'On/Off' key.
2. Place the dish in the oven.
3. Tap 'OVEN' to open the oven function menu.
4. Select an oven function (see 'Function-setting display' chapter).
5. Select a temperature (see 'Function-setting display' chapter).
6. Tap the 'cooking time' symbol and set a cooking time (see 'Function-setting display' chapter).



Cooking can also be started without a cooking time being set. You should then skip steps 6.

7. Select any additional settings using the 'Plus' menu (for example fast preheat).
8. Start cooking the dish using the confirm key.



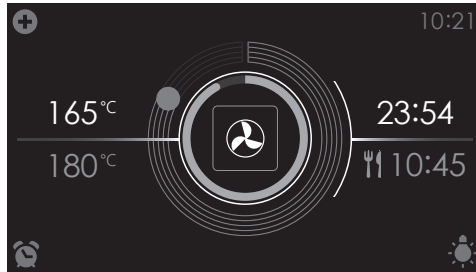

- The following values can now be read in the display:
 - current temperature (165 °C)
 - set temperature (180 °C)
 - status indicator time (outer circle)
 - status indicator temperature (inner circle)
 - cooking time (23:54)
 - end time (10:45)



- *Tap in the middle of the display during cooking to open a pop-up display with settings. Adjust these if desired.*
- *At the end of a dish's cooking time a sound signal will sound. The signal can be switched off by opening the oven door or pressing a key.*
- *The selected settings can be saved in 'Favourites'. Open 'ADD TO FAVOURITES' from the 'Plus' menu (See 'Saving a cooking method' in the 'Additional functions' chapter).*



Display view at the end of cooking.

Using the microwave

Microwaves are high-frequency electromagnetic waves. The energy makes it possible to cook or warm up dishes without affecting the form or colour.

- The microwave is used for:
 - Microwave function
 - Combi functions

Cooking principle

1. The microwaves generated by the microwave are spread evenly by a distribution system. This cooks the dish evenly.
2. The food absorbs the microwaves to a depth of approximately 2.5 cm. Cooking then continues, because the heat is spread in the dish.
3. The cooking times vary and depend on the dish you use and the properties of the food:
 - Quantity and density
 - Moisture content
 - Starting temperature (whether or not it is cooled)

Important

The dish is cooked from the inside out by means of heat distribution. The cooking continues even when you take the dish from the oven. Standing times in recipes and in this book should therefore be adhered to, in order to ensure:

- Even heating into the middle of the dish;
- Equal temperatures in all parts of the dish.

Guidelines for microwave cookware

Cookware that you use for the microwave function should not block the microwaves. Metals such as stainless steel, aluminium and copper reflect microwaves. For that reason, do not use metal cookware. Cookware which is designated as microwave-safe can be used safely. For more information about suitable cookware, consult the following guidelines and always use the glass baking tray on level 1 if you use the microwave function.

USE

Cookware	Microwave safe	Remarks
Aluminium foil	✓X	Can be used in small quantities to prevent certain parts of the dish from overcooking. Arcing can occur if the foil is too close to the oven wall or if too much foil is used.
Porcelain and earthenware	✓	Porcelain, earthenware, glazed earthenware and ivory porcelain are usually suitable, unless they have a metal edge.
Disposable crockery made from polyester or cardboard	✓	Frozen meals are sometimes packaged in disposable tableware.
Fast food packaging <ul style="list-style-type: none"> • Polystyrene cups • Paper bags or newspaper • Recycled paper or metal edges 	✓ X X	Can be used to warm up dishes. Polystyrene can melt if it overheats. Can catch fire. Can cause arcing.
Glassware <ul style="list-style-type: none"> • Oven dishes • Fine glassware • Glass jars 	✓	Can be used, unless it has a metal edge. Can be used to warm up dishes or liquids. Thin glass can break or shatter with sudden heating. The lid must be removed. Only suitable for warming.
Metal	X	Can cause arcing or fire.
Paper <ul style="list-style-type: none"> • Plates, cups, kitchen paper • Recycled paper 	✓ X	For short cooking times and warming. For absorbing excess moisture. Can cause arcing.
Plastic	✓	Especially heat-resistant thermoplastic material. Other types of plastic can warp or discolour at high temperatures. Do not use melamine plastic. Can be used to hold moisture. May not touch the food. Be careful when you remove the film; hot steam can escape. Only if boil-proof or ovenproof. Must not be airtight. If necessary, prick it with a fork.

- ✓ : Recommended
 ✓X : Careful
 X : Unsafe

Microwave function



Do not use metal cookware or utensils. See 'Guidelines for microwave cookware'. Do not preheat the oven.

Select a power level appropriate for the meal you are cooking. For this open the tab at the bottom of the display.

1. Switch on the oven using the 'On/Off' key.
2. Place the dish in the oven.
3. Tap on 'MICROWAVE' to select the microwave function.

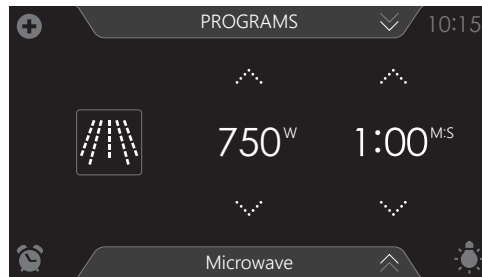

4. Select a power level (see 'Function-setting display' chapter).
5. Select a cooking time (see 'Function-setting display' chapter).
6. Start cooking the dish using the confirm key (04).

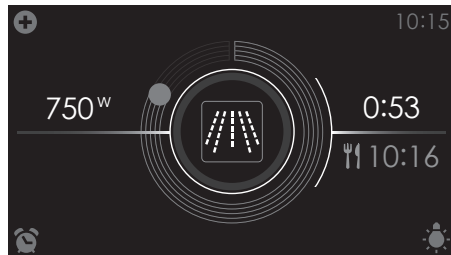

- The following values can now be read in the display:
 - ▷ set power level (750 W)
 - ▷ status indicator time (outer circle)
 - ▷ cooking time (00:53)
 - ▷ end time (10:16)

Microwave table

Power level	Use
1000 W	<ul style="list-style-type: none"> • For quick heating of drinks, water and dishes containing a lot of moisture. • For cooking fresh or frozen vegetables.
750 W	<ul style="list-style-type: none"> • For preparing and heating of drinks and dishes.
600 W	<ul style="list-style-type: none"> • For melting chocolate. • For cooking fish and seafood. • For heating on two levels. • For cooking dried beans at low temperatures. • For heating or cooking delicate dishes with eggs.
360 W	<ul style="list-style-type: none"> • For cooking dairy products or jam at low temperatures.
180 W	<ul style="list-style-type: none"> • For fast defrosting of dishes. • For softening butter or ice cream.
90 W	<ul style="list-style-type: none"> • For defrosting cakes containing cream.

Using the 'Extras' functions

Open the 'Extras' display to select a combi microwave setting or to preheat the oven quickly. A cleaning program, warming functions or automatic programs can also be selected.

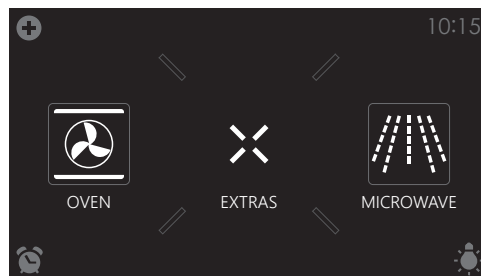

Tap on 'EXTRAS' to show the appliance's extra functions.

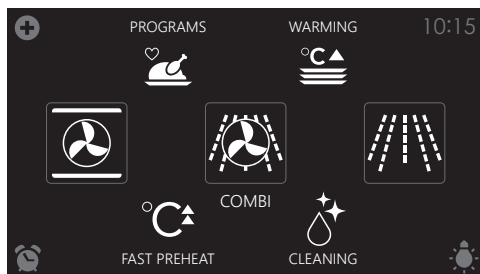

The following functions can now be selected:

- Fast preheat
- Combi
 - Hot air + Microwave
 - Grill + Fan + Microwave
- Cleaning (see 'Cleaning' chapter)
- Warming (see 'Additional functions' chapter):
 - Plate warming
 - Defrost
 - Keep warm
- Programs (see 'Additional functions' chapter):
 - Favourites
 - Automatic programs



Fast preheat

Use this oven function for preheating the oven quickly. Don't insert a dish during Fast preheat. When the oven is heated to the set temperature, preheating is finished and the oven is ready to cook the dish.

Using fast preheat

1. Switch on the oven using the 'On/Off' key.
2. Tap on 'EXTRAS' to show the appliance's extra functions.
3. Tap on 'FAST PREHEAT' to open the fast preheat function.

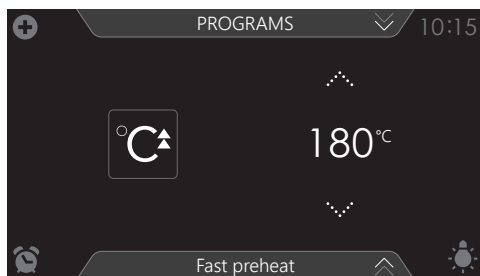

4. Select a temperature (see 'Function-setting display' chapter).
5. Start fast preheat using the confirm key.

- *Fast preheat can also be linked to a cooking process.*
- *Activate 'FAST PREHEAT' from the 'Plus' menu to do so.*
- *When the set temperature is reached, a pop-up will appear and a sound signal sounds.*
- *The cooking time starts counting up or down after door closing.*

Combi

- 2 different combi functions can be selected.
 - Hot air + Microwave
 - Grill + Fan + Microwave
- A temperature, the microwave power level and a cooking time can be set for each combi function.
- 'Plus' menu functions such as 'stage cooking' and 'delayed start' can also be activated. Tap on the plus symbol for this. See the 'Using the 'Plus' menu' chapter.

Using a combi function

Select the combi function appropriate for the meal you are cooking. Consult the Functions table for this. You can also consult the info tab. Tap on the tab at the bottom of the display to request information about the current function.

1. Switch on the oven using the 'On/Off' key.
2. Place the dish in the oven.
3. Tap on 'EXTRAS' to show the appliance's extra functions.
4. Tap on 'COMBI' to open the combi function menu.

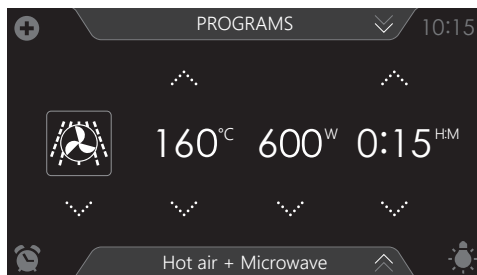

5. Select a combi function (see 'Function-setting display' chapter).
6. Select a temperature (see 'Function-setting display' chapter).
7. Select a power level (see 'Function-setting display' chapter).
8. Select a cooking time (see 'Function-setting display' chapter).
9. Select any additional settings using the 'Plus' menu.
10. Start cooking the dish using the confirm key.

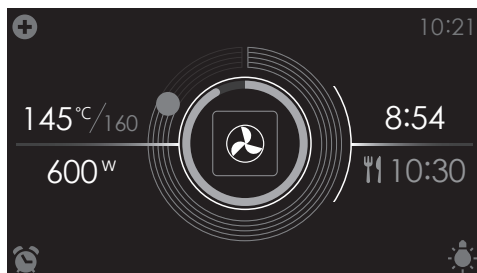







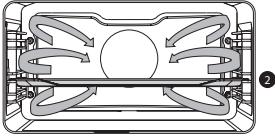

- The following values can now be read in the display:
 - current temperature (145 °C) / set temperature (160 °C)
 - selected power level (600 W)
 - status indicator time (outer circle)
 - status indicator temperature (inner circle)
 - cooking time (08:54)
 - end time (10:30)
- Tap in the centre of the display during cooking to open a pop-up display with all settings. Adjust these if desired.
- At the end of a dish's cooking time a sound signal will sound. The signal can be switched off by opening the oven door or pressing a key.
- The selected settings can be saved in 'Favourites'. Open 'ADD TO FAVOURITES' from the 'Plus' menu (See 'Saving a cooking method' in the 'Additional functions' chapter).

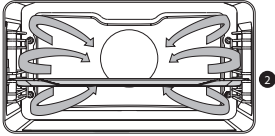



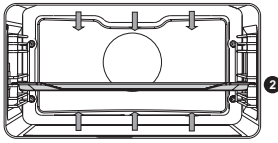

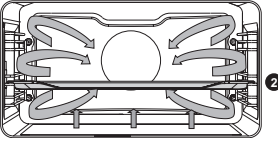

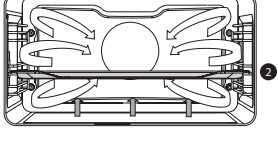

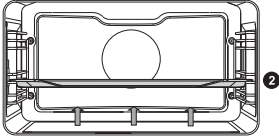

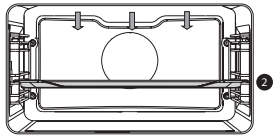

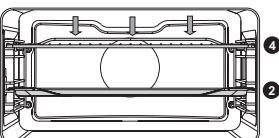

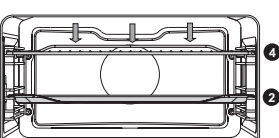
Functions table



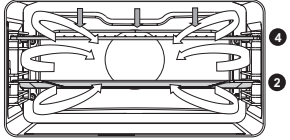

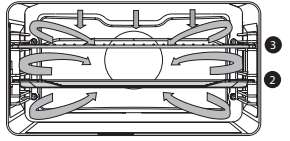

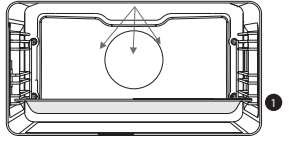
Consult the table to choose the desired function. Also consult the instructions for preparation on the dish packaging.

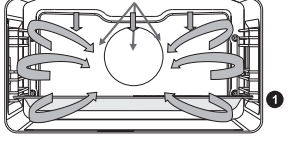
Function	Description	
Oven functions		
	<p>Hot Air</p> <ul style="list-style-type: none"> • Heating by means of hot air from the back of the oven. • This mode provides uniform heating and is ideal for baking. • Place the baking tray or oven rack in the middle of the oven. • Suggested temperature: 180 °C • Preheating is recommended. 	
	<p>ECO Hot air</p> <ul style="list-style-type: none"> • Heating by means of hot air. ECO hot air uses less energy but gives the same result as the hot air setting. Cooking takes a few minutes longer. • This mode can be used for roasting meat and baking pastry. • Place the baking tray or oven rack in the middle of the oven. • Suggested temperature: 180 °C • This setting makes use of the residual heat (heating is not on the whole time) to achieve low energy consumption (in accordance with energy class EN 60350-1). In this mode the actual temperature in the oven is not displayed. 	

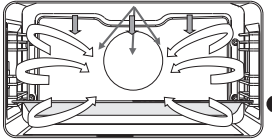
Function	Description	
	<p>Top + Bottom heat</p> <ul style="list-style-type: none"> • Heating by means of the upper and lower heating elements. • This mode can be used for traditional baking and roasting. • Place the baking tray or oven rack in the middle of the oven. • Suggested temperature: 200 °C • Preheating is recommended. 	
	<p>Hot air + Bottom heat</p> <ul style="list-style-type: none"> • Heating by means of hot air from the back of the oven and the bottom heating element. • This mode can be used to bake pizza, moist pastry, fruitcakes, leavened dough and short crust. • Place the baking tray or oven rack in the middle of the oven. • Suggested temperature: 200 °C • Preheating is recommended. 	
	<p>Bottom heat + Fan</p> <ul style="list-style-type: none"> • Heating by means of the lower heating element. The heat is distributed by the fan. • This mode can be used for baking low leavened cakes, as well as for preservation of fruit and vegetables. • Place a not too high baking tray in the lower part of the oven, so that hot air can also circulate over the upper surface of the food. • Suggested temperature: 180 °C 	

Function	Description	
	<p>Bottom Heat</p> <ul style="list-style-type: none"> • Heating only by means of the lower heating element. • This mode can be used with dishes and baked goods that require a distinctive bottom crust or browning. • Place the baking tray or oven rack in the lower part of the oven. • Use just before the end of the baking or roasting time. • Suggested temperature: 160 °C 	
	<p>Top Heat</p> <ul style="list-style-type: none"> • Heating only by means of the upper heating element. • This mode can be used when you wish to bake/roast the top part of your dish. • Place the baking tray or oven rack in the middle of the oven. • Suggested temperature: 150 °C 	
	<p>Grill</p> <ul style="list-style-type: none"> • Heating by means of the grill element. • This mode can be used for grilling a smaller amount of open sandwiches, beer sausages, and for toasting bread. • Place the oven rack in the upper part of the oven and the baking tray in the middle of the oven. • Maximum allowed temperature 240 °C. • Monitor the cooking process at all times. The dish may burn quickly due to the high temperature. • Preheat for 5 minutes. 	
	<p>Large Grill</p> <ul style="list-style-type: none"> • Heating by means of the upper element and grill element. • This mode can be used with dishes and baked goods that require a distinctive bottom crust or browning. Use just before the end of the baking or roasting time. • Place the oven rack in the upper part of the oven and the baking tray in the middle of the oven. • Maximum allowed temperature 240 °C. • Monitor the cooking process at all times. The dish may burn quickly due to the high temperature. • Preheat for 5 minutes. 	

Function	Description	
	<p>Large grill + fan</p> <ul style="list-style-type: none"> • Heating by means of the top heating elements. The heat is distributed by the fan. • This mode can be used for grilling meat, fish and vegetables. • Place the oven rack in the upper part of the oven and the baking tray in the middle of the oven. • Suggested temperature: 170 °C • Monitor the cooking process at all times. The dish may burn quickly due to the high temperature. • Preheat for 5 minutes. 	
	<p>Pro Roasting</p> <ul style="list-style-type: none"> • This setting has an automatic heating cycle. • First the meat is sealed at a high temperature by means of hot air and the top heating element. • Then the dish is slowly cooked at the low, preset temperature, with the top and bottom heating elements. • This function is suitable for meat, poultry and fish. • Suggested temperature: 180 °C 	
Microwave function		
	<p>Microwave</p> <ul style="list-style-type: none"> • This function uses microwaves. Dishes are defrosted, heated or cooked quickly and efficiently. • Place the glass baking tray on level 1. • Suggested power: 750 W 	
	<p>Hot air + Microwave</p> <ul style="list-style-type: none"> • The dish is cooked with a combination of microwaves and hot air. This shortens the cooking time, but the dishes do get a nice brown crispy top. • This function is used to cook meat, poultry and vegetables. But also for casseroles, cakes and bread. • Place the glass baking tray on level 1. • Suggested temperature: 160 °C • Suggested power: 600 W 	

Function	Description	
	<p>Grill + Fan + Microwave</p> <ul style="list-style-type: none"> • The dish is cooked with a combination of microwaves, grill and fan. This shortens the cooking time, but the dishes do get a nice brown crispy top. • This setting is suitable for cooking small portions or thin pieces of fish, meat or poultry. • Place the glass baking tray on level 1. • Suggested temperature: 200 °C • Suggested power: 600 W 	
Extra functions		
	<p>Fast preheat</p> <ul style="list-style-type: none"> • With this function, the oven cavity is quickly heated to the desired temperature. Do not use this setting when you have a dish in the oven. • Suggested temperature: 180 °C 	
	<p>Plate warming</p> <ul style="list-style-type: none"> • This function is used for warming tableware, so that the served food stays hotter for longer. • Suggested temperature: 60 °C 	
	<p>Defrost</p> <ul style="list-style-type: none"> • This function uses microwaves. Dishes are defrosted quickly and efficiently. • Suggested power: 90 W 	
	<p>Keep warm</p> <ul style="list-style-type: none"> • This function is used to keep already cooked dishes warm. • Suggested temperature: 60 °C 	
	<p>Steam clean</p> <ul style="list-style-type: none"> • With this function and a damp cloth, you can easily remove grease and dirt from the oven walls. • Use this function only when the oven has cooled down fully. Pour 0,15 liters of water onto the bottom of the oven space before starting the cleaning process. • After soaking, food residues can be removed with a damp cloth. 	

Delayed start

Use the 'delayed start' function to start cooking at a later time. The delayed start function can only be selected via the 'Plus' menu in an oven function or combi function. See the 'Using the 'Plus' menu' chapter.

Setting a delayed start time

1. Select a function, temperature and set a cooking time if necessary (see 'Function-setting display' chapter).



A delayed start time can also be set without setting a cooking time.

2. Tap the 'plus' symbol to open the 'Plus' menu.
3. Tap on 'DELAYED START' to open the function.

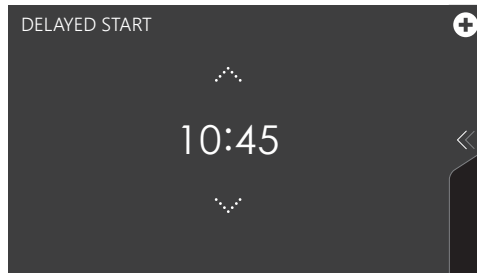

4. Select a start time (see 'Function-setting display' chapter).
5. Confirm the set start time using the confirm key.

The 'delayed start time' icon appears under the plus symbol to indicate activation. The delayed start time can be deselected by returning the setting to the current time.

6. Start cooking using the confirm key.



The cooking will start automatically at the set time. If a cooking time has been set, the cooking will also stop automatically.

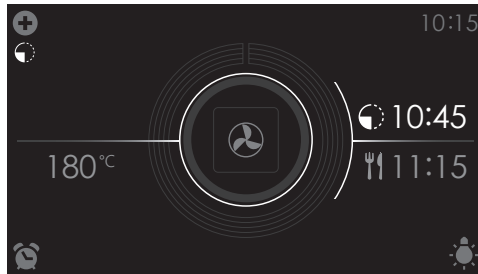

- The following values can now be read in the display:
 - ▷ set temperature (180 °C)
 - ▷ start time (10:45)
 - ▷ end time (11:15) (only visible if a cooking time has been set!)

Stage cooking

- Open the 'Stage cooking' menu via the 'Plus' menu. See the 'Using the 'Plus' menu' chapter.
- This function allows you to combine up to three functions in one cooking process.
- Select different functions and settings to compose the cooking process of your preference.

1. Tap the plus symbol to open the 'Plus' menu.
2. Tap 'STAGE COOKING' to open the function (can only be opened if no cooking process has started). The stage 1 settings are visible. These can be adjusted if desired.



3. Select a function (see 'Function-setting display' chapter).
4. Select a temperature (see 'Function-setting display' chapter).
5. Select a power level (see 'Function-setting display' chapter).



6. Select a cooking time (see 'Function-setting display' chapter).
7. Confirm the setting of stage 1 using the confirm key.

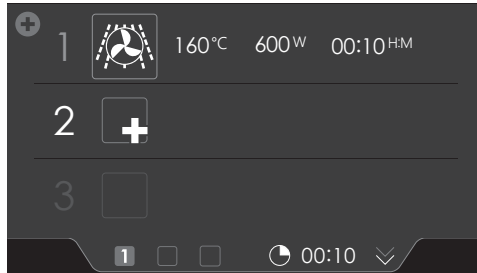

8. Tap on '2' to show the stage 2 settings.
9. If necessary change the stage 2 default values (function, temperature/power level and cooking time) (see points 3 - 6).

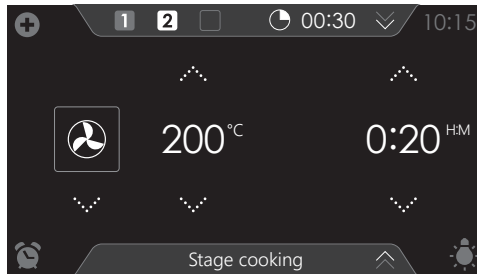

10. Confirm the setting of stage 2 using the confirm key.

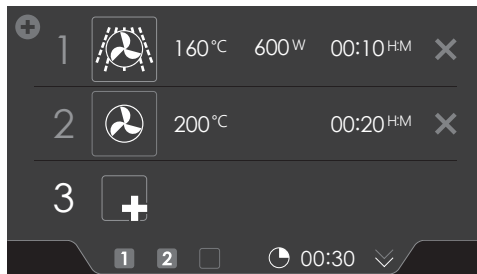

11. If desired, tap on '3' to show the stage 3 settings.
12. If necessary change the stage 3 default values (function, temperature/power level and cooking time) (see points 3 - 6).
13. Confirm the setting of stage 3 using the confirm key.





Delete a stage by tapping on the cross next to the settings.
A stage can only be deleted if it has not yet started.

14. By pressing the confirm key again, the oven starts to work according to stage 1 (the activated stage is displayed in white). When the set time has elapsed, the following stage will be activated, this being stage 2 and later stage 3 if this has been set.



The selected settings can be saved in 'Favourites'.
Open 'ADD TO FAVOURITES' from the 'Plus' menu (See 'Saving a cooking method' in the 'Additional functions' chapter).

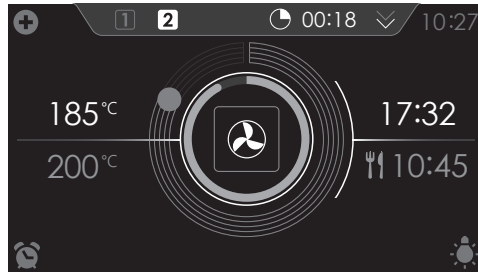

- The following values can now be read in the display:
 - active stage (2)
 - total cooking time (00:18)
 - current temperature (185 °C)
 - active stage set temperature (200 °C)
 - active stage status indicator time (outer circle)
 - active stage status indicator temperature (inner circle)
 - active stage cooking time (17:32)
 - total end time (10:45)

Gratin

To add the grill function at the end of the progress (gratin time will be added at the end of the cooking process).

1. Tap the 'plus' symbol to open the 'Plus' menu .
2. Tap on 'GRATIN' to open the function.
3. The temperature and time can be set or the program can be started directly by pressing the confirm key.

Additional functions

Several additional functions or programs can be selected.

1. Tap on 'EXTRAS' to show the appliance's extra functions.

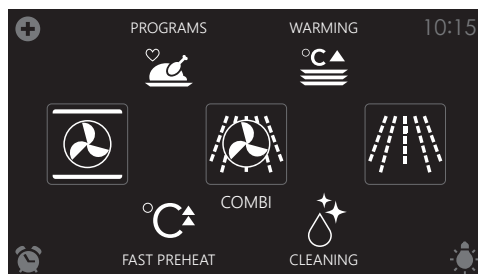

The following additional functions and programs can now be selected:

- Warming:
 - Plate warming
 - Defrost
 - Keep warm
- Programs:
 - Favourites
 - Automatic programs

Warming

- Plate warming
 - This function is used when you want to warm tableware (plates, cups) so that the served food stays hotter for longer.
 - By choosing this function you can determine the plate warming temperature and duration.
- Defrost
 - This function uses microwaves. Dishes are defrosted quickly and efficiently. Use this function for slow defrosting of frozen dishes (cakes, biscuits, cookies, bread, bread rolls and frozen fruit).
 - By choosing this function you can determine the defrost power level and duration.
 - Turn the food over after half the defrost time has elapsed; stir the food or break up large pieces if these are frozen together.
- Keep warm
 - Use this function to keep already cooked food at temperature.
 - By choosing this function you can determine the keep warm temperature and duration.

Selecting warming functions

1. Tap on 'EXTRAS' to show the appliance's extra functions.
2. Tap on 'WARMING' to open the warming function menu.

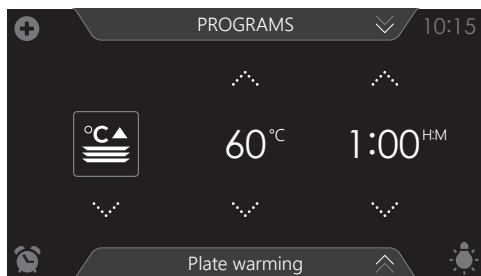

3. Choose the desired warming function (plate warming, defrost or keep warm). Adjust the settings if necessary (see 'Function-setting display' chapter)
4. Start the function using the confirm key.



Programs:

- Favourites
 - You can select your own stored recipes in 'FAVOURITES'. See also 'Saving a cooking method'.
- Automatic programs
 - You can use 'automatic programs' for cooking by selecting a dish from a list of pre-programmed dishes. The programs are subdivided into categories (MEAT, VEGETABLES, etc.).
 - First select the category and then the dish itself from the available list.

Selecting program functions

1. Tap on 'EXTRAS' to show the appliance's extra functions.
2. Tap on 'PROGRAMS' to open the programs menu.

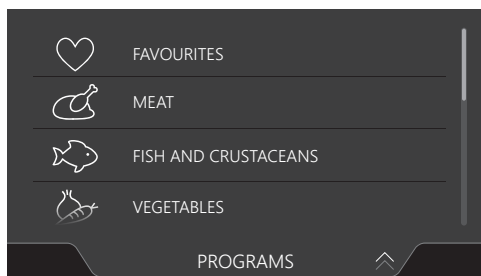

3. Tap on 'FAVOURITES' or one of the automatic program categories.
 - Select one of your saved dishes in 'FAVOURITES'.
 - Select a dish from the available list in the automatic programs.

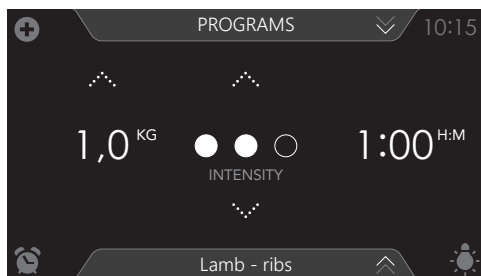
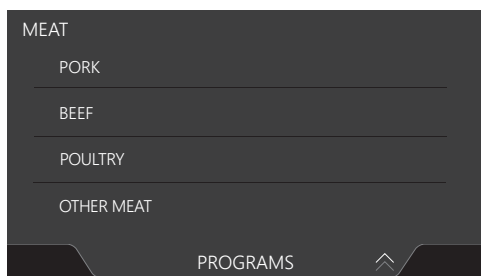

4. If necessary adjust the intensity and/or the weight.

The intensity or weight cannot be adjusted in all automatic programs.

5. Start the chosen program using the confirm key.





- Open information about the chosen program using the info tab. Information about the required accessories and the shelf level in the oven can be read in this tab. Sometimes information about cooking the dish may also be found in this tab.
- For a number of automatic programs, it is sometimes possible to adjust settings manually. For adjusting the settings open the 'Plus' menu and tap 'MANUAL'.

Saving a cooking method

A function/cooking method is active (the oven has started).

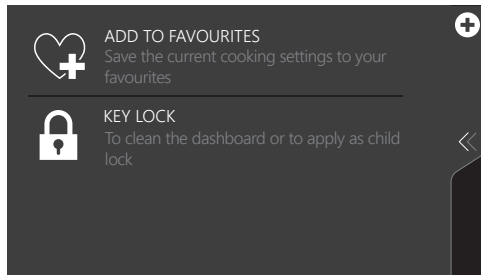

1. Open the 'Plus' menu and tap on 'ADD TO FAVOURITES'.

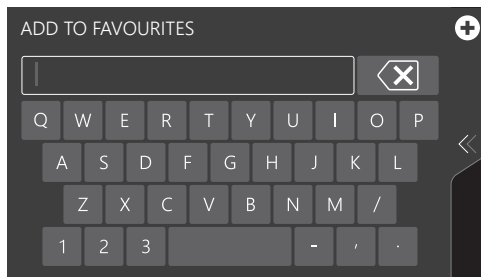

2. Give the dish you are preparing a name by selecting the appropriate letters. Tap on the 'arrow with cross' symbol if you wish to delete a letter.
3. Press on the confirm key to save the cooking method.



Automatic programs can also be saved under 'FAVOURITES'.

Settings

1. From the start display, tap on the plus symbol.

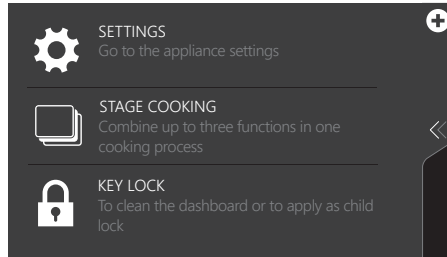

2. Tap on 'SETTINGS'.

This menu offers the following choices:

- General
- Sound
- Display and light
- Cooking
- System

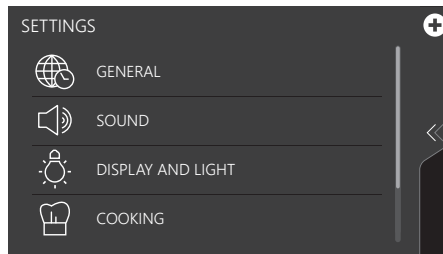

3. Tap on the desired category and the setting to be adjusted.
 - tap on the desired choice from a list
 - adjust a value by tapping the arrows above and below the value or swiping over the value
 - or switch a setting on or off by tapping on 'ON' or 'OFF'
4. Press the confirm key to confirm.



GENERAL

You can set the following from this menu:

- Language (language of the touch screen)
- Time (Current time)
- Time display (12 or 24 hour clock)
- Date (current date)
- Date display (date visible or not in the 'stand-by' display)

SOUND

You can set the following from this menu:

- General sounds (volume of sound signals and alarms)
- Key sounds (volume of key sounds)
- Start-up/shut-down sound (volume of start-up/shut-down sound)

DISPLAY AND LIGHT

You can set the following from this menu:

- Display brightness (adjustable in 5 brightness levels)
- Oven light (the time the light stays on after activation)
- Appliance to stand-by mode (the length of time before the appliance goes to stand-by after the last operation)
- Appliance switch off (how long the appliance stays in stand-by)
- Start-up/shut-down animation (start-up/shut-down of the brand animation)
- Night mode (start and end time for lower display brightness)



When for 'APPLIANCE SWITCH OFF' setting 'Manual' is selected, the appliance does not switch off automatically. When the device is switched off manually, this setting is put back to the factory setting. This is a mandatory maximum energy consumption regulation.

COOKING

You can set the following from this menu:

- Quick start microwave (adjust power level and time of quick start)
- Default program intensity (intensity of automatic programs)

SYSTEM

You can set the following from this menu:

- Appliance information (request appliance information)
- Factory settings (back to factory settings)

Cleaning the appliance

Clean the oven regularly to prevent fat and food particles from accumulating, especially on the surfaces of the interior and the exterior, the door and the seal.

- Activate the child lock (to prevent that the appliance is switched on accidentally).
- Clean the exterior surfaces with a soft cloth and warm soapy water.
- Next wipe with a clean, damp cloth and dry the surfaces.
- Remove splashes and stains on the interior surfaces with a cloth and soapy water.
- Next wipe with a clean, damp cloth and dry the surfaces.



Important

- Make sure that no water enters the vents.
- Never use abrasive cleaning materials or chemical solvents.
- Always make sure that the seal of the door is clean. This prevents accumulation of dirt and allows you to close the door properly.

Steam clean

With the steam clean function and a damp cloth, you can easily remove grease and dirt from the oven walls.

Using steam clean

Only use steam clean when the oven has cooled down fully. It is more difficult to remove dirt and grease if the oven is hot.

1. Remove all accessories from the oven.
2. Pour 0.15 litres of water into the bottom of the oven.
3. Tap on 'EXTRAS' to show the appliance's extra functions.
4. Tap on 'CLEANING' to open the cleaning function.
5. Press on the confirm key to start steam clean.



- *Do not open the door during the cleaning process.*
- *The process takes 30 minutes.*
Food remains on the enamel walls will be sufficiently soaked after 30 minutes so that they can be removed with a damp cloth.

CLEANING

Removing and cleaning the guide rails

Use conventional cleaning products to clean the guide rails.

- Remove the screw using a screwdriver.
- Remove the guide rails from the holes in the back wall. Save the guide rail spacers carefully. Return the spacers after cleaning. This prevents sparks being created during use.

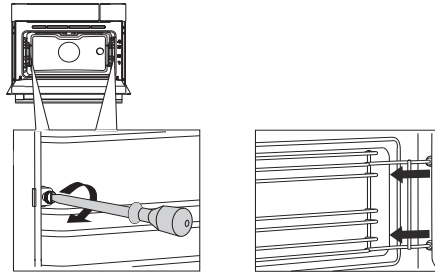

Replacing the oven light bulb

The light bulbs (2x) (halogen G9, 230 V, 25 W) are a consumer items and therefore not covered by warranty. To replace it, first remove the baking tray, oven rack and guide rails.



The lamp in this household appliance is only suitable for illumination of this appliance. The lamp is not suitable for household room illumination.

Disconnect the appliance from the power supply by removing the plug from the socket or by switching off the circuit breaker in the fuse box.

Please note: the light bulb can be very hot! Use protection to remove the bulb.

1. Unscrew the cover panel's four screws. Remove the cover panel and glass.
2. Remove the faulty halogen lamp and replace it with a new one. To prevent burns, use protection to remove the lamp.
3. Do not remove the seal from the cover panel. The seal needs to fit perfectly in the oven wall recess.

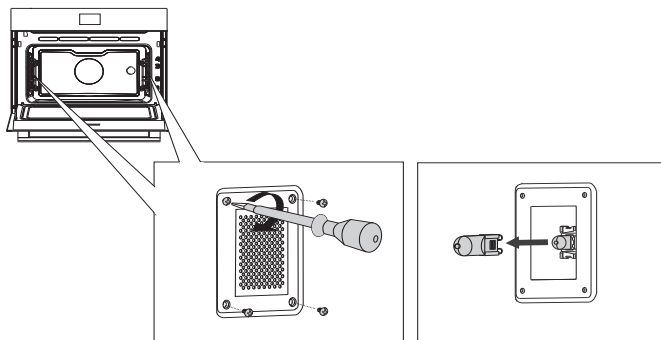

General

If you have problems with your oven, consult the error overview below. Should the problems persist, please contact the Customer Services Department.

The food stays raw

- Check whether the timer has been set and you have pressed the confirm key.
- Is the door closed properly?
- Check whether a fuse has blown and whether a circuit breaker has been activated.

The food is overcooked or undercooked

- Check whether the correct cooking time has been set.
- Check whether the correct power has been set.

The sensors don't respond; the display is locked.

- Disconnect the appliance from the power supply for a few minutes (unscrew the fuse or switch off the mains); then reconnect the appliance and switch it on.

Sparking in the oven space.

- Ensure that all cover panels from the lamps are secure and that all spacers are placed on the guide rails.

Power failure can cause the display to reset.

- Remove the plug from the socket and put it back in again.
- Set the time again.

There is condensation in the oven.

- This is normal. Wipe the oven clean after use.

The fan keeps working after the oven is switched off.

- This is normal. The fan will keep working for a while after the oven is switched off.

Air flow can be felt at the door and the exterior of the appliance.

- This is normal.

Steam escapes from the door or the vents.

- This is normal.

Clicking sounds can be heard when the oven is working, particularly in the defrost setting.

- This is normal.

The fuse switches off regularly.

- Consult a service technician.

The display gives an error code, ERROR XX ...

(XX indicates the number of the error).

- There is a fault in the electronic module. Disconnect the appliance from the power supply for a few minutes. Then reconnect it and set the current time.
- Consult a service technician if the error persists.

Storing and repairing the oven

Repairs should only be performed by a qualified service technician.

If maintenance is required, take the plug from the socket and contact the Asko customer service.

Have the following information to hand when you call:

- The model number and serial number (stated on the inside of the oven door)
- Guarantee details
- A clear description of the problem



Choose a clean, dry place if you have to store the oven temporarily, as dust and moisture can damage the appliance.

Disposal of the appliance and packaging

This product is made from sustainable materials. However, the appliance must be disposed of responsibly at the end of its useful life. The government can provide you with information about this.

The packaging of the appliance can be recycled. The following materials have been used:

- cardboard
- polyethylene wrap (PE)
- CFC-free polystyrene (hard PS foam)

Dispose of these materials responsibly in accordance with legal provisions.



The product has a pictogram of a rubbish bin with a cross through it. This indicates that household appliances must be disposed of separately. This means that the appliance may not be processed via the regular waste flow at the end of its useful life. You should take it to a special municipal waste depot or a sales outlet that offers to do this for you.

Collecting household equipment separately prevents harm to the environment and public health. The materials used in manufacturing this appliance can be recycled, which provides considerable savings in energy and raw materials.

Declaration of conformity



We hereby declare that our products comply with the relevant European directives, standards and regulations as well as all requirements referred to in the standards.

 **ASKO**



688564

en (02-20)